



EL & EL Wood Products
HALF A CENTURY OF SERVICE



details

EL&EL MOULDING COLLECTION

MDF HARDWOODS PINE REDWOOD FIR ACCESSORIES DOORS

Character, built in.™

DISTRIBUTED BY



CONVENIENT TABBED DIVIDERS
Fold out for fast access to the sections you use most.

Accessories

THE LITTLE THINGS MAKE THE DIFFERENCE



Accessories add to the architectural sophistication of any room, as well as to your individual sense of style. With so many custom choices you can shape and mold to fit any architectural challenge. Get creative with ValuFlex™ flexible mouldings that match and mimic the grain of your chosen specie. Rosettes and plinth blocks add unforgettable detail and dimension, greater than the casing and base alone.

section contents

Base Plinth Blocks	6
Dowels / Dowel Pins	8
Finishing Instructions.....	14
Flexible Mouldings.....	2
Majestic Mantels.....	9
Plugs	8
Radius Base Corners.....	4
Rosette Plinth Blocks.....	5
Screwhole Plugs	8
Simple Solutions™ Flush Crown Corners ...	4



Accessories

THE LITTLE THINGS MAKE THE DIFFERENCE



MAJESTIC
Mantels

Accessories help to create a more sophisticated, individual look for your home or office. Accessories offer custom choices to shape and mold any architectural need.

Simple Solutions™, a flush miterless crown corner system, provides hassle-free installation, architectural enhancement and can be used with radiused drywall or square corners.

Radius Bullnose Base Corners match the baseboard profiles being installed and continue the radius look of rounded drywall corners. With time and attention to detail, base corners soften and enhance the entire look of any home and are available in most base profiles and species.

Flexible Mouldings are manufactured on our premises and offer a perfect match to our moulding profiles. ValuFlex™ is used for any radius or curve of a wall, window or decorative element. When painted or stained, flexible moulding has the beauty, look and feel of real wood and costs less than radiused wood millwork.

Rosettes and Base Plinth Blocks are considered traditional, yet add a beautiful architectural element. No mitering and easy installation make them a favorable choice for adding detail. When choosing a baseboard that is thicker than your casing, simply put a thicker block at the bottom of your casing that is 1/4" or greater in thickness and in height than the baseboard.

EL & EL is proud to introduce a new line of mantels and mantel surrounds. From simple to upscale, choose a mantel that will enhance the look of your existing fireplace or perfectly complete a new project. Majestic Mantels™ are affordable and easy to install. Add unique character to any room in your home with mantel shelves.

architectural enhancement

sharp details

faux finish, stain, or paint



(items are approximate scale only)

Flexible Mouldings

1

easy to order



Your order will arrive
in 2-3 days.

2

easy to match



Your pattern will be
matched exactly.

3

easy to love



Your satisfaction is
100% guaranteed.

ValuFlex™



EL & EL Wood Products manufactures on its premises, ValuFlex™ Flexible Mouldings—the highest quality urethane available in today's market.

easy to match ANY PROFILE

Whether you're adding trim to arched windows or curved walls, it's **easy** to match any moulding profile with **ValuFlex™** from EL & EL.

This innovative material handles and finishes like real wood and is engineered to resist cracking, warping, splitting and mildewing. Extreme flexibility, less shrinkage and more detail make ValuFlex™ the right choice when a perfect match is a must.

- ✓ Superior lead-time
- ✓ Match any profile
- ✓ Incredible detail
- ✓ Paints or stains beautifully
- ✓ Tear resistant
- ✓ Minimal shrinkage
- ✓ Limited 5-year warranty
- ✓ Custom profiles available
- ✓ Manufactured on our premises

base | casing | crown | chair rail | jambs | built-ups



ValuFlex™ When a perfect match is a must!

All the advantages of radiused wood at a fraction of the cost.



"Yes, you can stain it!"

easy to order

Use part number of desired pattern, the species and add an "F" for ValuFlex™.

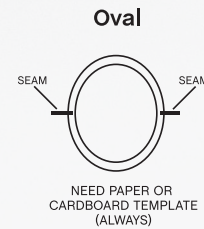
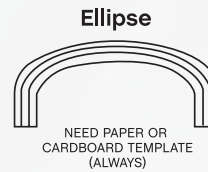
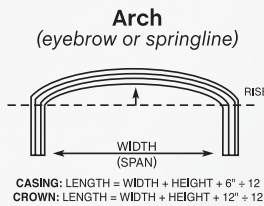
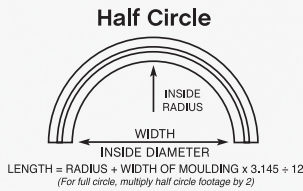

Casing

- On true half-circles, order by radius (equals 1/2 of diameter) or by diameter. (Please state "radius" or "diameter" when ordering.)
- When ordering arches, please state "span and rise" (ie: 21" span x 6" rise)
- Ellipses always require a template.

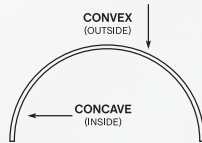

Crown

- Does the wall curve inside (concave) or outside (convex)?
- Radius of wall - IR (inside radius), OR (outside radius).
- Length of moulding needed (add for waste) to cover entire area.
- How many pieces?

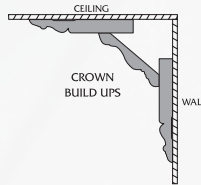

Crown Build Ups

- Order as IR (Concave) or OR (Convex) radius.
- Any moulding used on the wall: order as straight.
- Any moulding used on the ceiling: order as a radius.
 - On an OR (outside radius), you must add the projection of the crown to the ceiling moulding radius. Example: If using the 330MUL on a ceiling with the 410MUL crown which has a projection of 4-1/2" and the wall is a 60" radius, 330MUL should be ordered as a 64-1/2" radius.
 - On an IR (inside radius), you must subtract the projection of the crown from the radius, therefore a wall with a 60" radius less the 4-1/2" projection = 55-1/2" IR for the 330MUL.

Base

- If Base is being used as Baseboard or as part of a Crown detail on a wall, the Flex Base does not need to be pre-cast to any radius. They are sold as straights and only total lineal footage is needed.
- If Baseboards are used as Casing the base must be ordered to the radius (like section I). If base is being used as part of a Crown detail where they lay flat on the ceiling (not on the wall), then information as indicated in section III C1 or C2 must be provided.

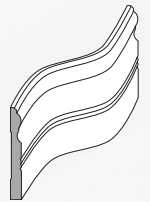

Panel Moulds/Lineal Moulds/Chair Rail

- If used horizontally on curved walls, straight lengths will work.

Backbands

- Radius on main casing that backband is to attach to.
- Type of curve (arch, ellipse, half-circle and information under Casings)
- Moulding part numbers, species, length, and count.

HINT: HOW TO FIGURE A RADIUS

Concave - IR
Inside Application

Convex - OR
Outside Application

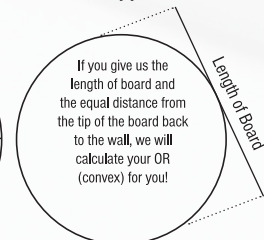
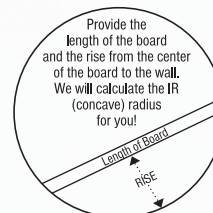

Flex, manufactured by EL & EL, assures a perfect match to any of our moulding profiles.

General Information

ValuFlex™ is a urethane resin and can be used for most interior or exterior profiles.



TO PAINT

- 1) Fill and sand, like wood, using a filler that will adhere to an oil based man-made product.
- 2) If using water based Latex paint, proceed as you would with any paintable product. If you are using an oil based paint, apply 2 base coats of Latex Enamel (water based) paint as an underbody. Do not use primer as an underbody when using oil based paint. Use a water born enamel paint as a primer. This will ensure proper drying of the oil based paint by providing a seal between the urethane and the oil based paint.
- 3) Apply Latex Enamel or Oil Based Enamel, like the straight mouldings, and finish the same.



TO STAIN

- 1) Finish and sand, like wood, using a filler that matches stain color and will adhere to an oil based man-made product.
- 2) Apply a pre-packaged "Base Coat Latex Glazing Fluid." Many manufactures offer these specific finishes for this purpose. After applying, wipe gently with a clean cloth. Re-apply stain as many times as needed to develop depth of color.
- 3) After the glaze has been wiped to the desired appearance, it must be allowed to dry and then sealed with the same top coat being used on the wood.
- 4) We strongly recommend that first time users practice on a piece of scrap flex moulding before finishing the moulding being used on the job.

Simple Solutions™ Flush Crown Corners

(items are approximate scale only)

Simple Solutions™ is a new resin miterless crown corner solution to ease installation and create a great finished look. No mitering, no difficult angle configurations, no need for additional material (in case of mitering errors) and best of all, Simple Solutions™ crown corners will

enhance and add architectural beauty and interest to any home. Simple Solutions™ miterless crown corners are available for inside, outside and bullnosed corners. Simple Solutions™ crown corners are available for most Ultralite MDF (MUL) crown profiles only.



Outside



Bullnose

Inside

Radius Base Corners

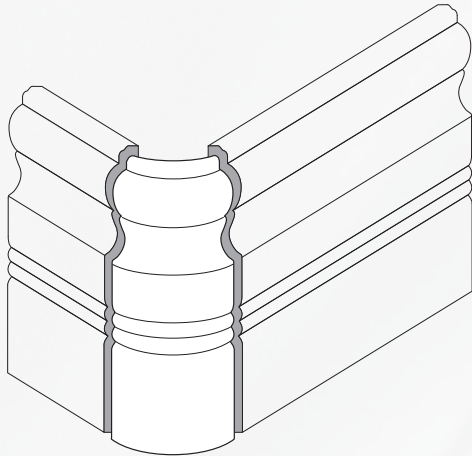

Straight mouldings fit flush to radius corner blocks making professional installation quick and easy.

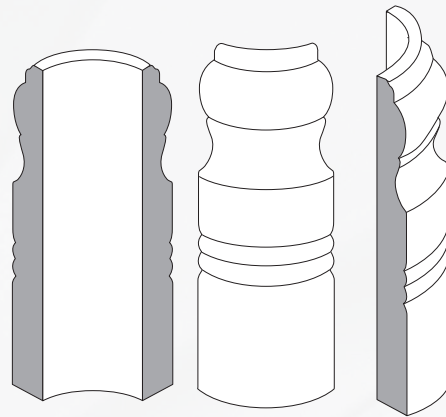

Bullnose Base Corners

Known as bullnose corners, quite popular today, many homes offer the look of eased rounded corners where drywall edges meet.

These rounded edges soften a home and enhance the entire look of the house. When the baseboard is installed, radius corners continue the eased corner look. A beautiful and elegant enhancement at very little cost.

Radius corners can be manufactured in any wood species.

All base profiles are available in radius corners for 3/4" drywall. Custom radius corners are available upon request.

(items are approximate scale only)

Rosette Plinth Blocks

NOW AVAILABLE IN: Poplar, Oak, MDF, Cherry, Maple & Alder



(PB3 shown)

Wellington Rosette w/Edge Detail



TIP
When ordering Rosettes, order 1/4" wider and thicker than the casing being used.

DIMENSION	POPLAR (PAINTGRADE)	OAK (-O)	MDF (MDF)	CHERRY (C)	MAPLE (MP)	ALDER (ALD)
7/8 x 2-3/4	PB1	PB1-O	—	—	—	—
7/8 x 3-1/2	PB2	PB2-O	—	—	—	—
7/8 x 3-3/4	PB3	PB3-O	—	—	—	—
7/8 x 5-3/4	PB4	PB4-O	—	—	—	—
1 x 4	ROS158	ROS158-O	—	—	—	—
1 x 3-3/4	ROS160	ROS160-O	ROS160MDF	ROS160C	ROS160MP	ROS160ALD
1 x 2-3/4	ROS162	ROS162-O	ROS162MDF	ROS162C	ROS162MP	ROS162ALD
1 x 4-1/2	ROS164	ROS164-O	ROS164MDF	ROS164C	ROS164MP	ROS164ALD
1 x 5-1/2	ROS165	ROS165-O	ROS165MDF	ROS165C	ROS165MP	ROS165ALD
1 x 3-1/2	ROS169	ROS169-O	ROS169MDF	ROS169C	ROS169MP	ROS169ALD
3/4 x 2-1/2	—	—	ROS170MDF	—	—	—
3/4 x 3-1/4	—	—	ROS171MDF	—	—	—
3/4 x 3-1/2	—	—	ROS172MDF	—	—	—

Cambridge Rosette without Edge Detail



DIMENSION	POPLAR (PAINTGRADE)	OAK (-O)	MDF (MDF)	CHERRY (C)	MAPLE (MP)	ALDER (ALD)
7/8 x 2-3/4	PB6	PB6-O	—	—	—	—
7/8 x 3-1/2	PB7	PB7-O	—	—	—	—
7/8 x 3-3/4	PB8	PB8-O	—	—	—	—
5/8 x 2-1/2	PB9	PB9-O	—	—	—	—
3/4 x 3-1/4	PB10	PB10-O	—	—	—	—
3/4 x 3-1/2	PB11	PB11-O	—	—	—	—
1 x 2-3/4	PB20	PB20-O	PB20MDF	PB20C	PB20MP	PB20ALD
1 x 3-1/2	PB21	PB21-O	PB21MDF	PB21C	PB21MP	PB21ALD
1 x 3-3/4	PB22	PB22-O	PB22MDF	PB22C	PB22MP	PB22ALD
1 x 4-1/2	PB23	PB23-O	PB23MDF	PB23C	PB23MP	PB23ALD
1 x 5-1/2	PB24	PB24-O	PB24MDF	PB24C	PB24MP	PB24ALD



Architectural Rosette

DIMENSION	POPLAR (PAINTGRADE)	OAK (-O)
1 x 3-3/4 x 5-3/4	ROS166	ROS166-O
1 x 4-1/2 x 6-1/2	ROS167	ROS167-O
1 x 5-1/2 x 7-1/2	ROS168	ROS168-O

Base Plinth Blocks

(items are approximate scale only)

NOW AVAILABLE IN: Poplar, Oak, MDF, Cherry, Maple & Alder

① Base blocks should be 1/4"-1" wider than casing and 1/2"-2" taller than base.



Springfield Base Block w/Edge Detail

DIMENSION	POPLAR (PAINTGRADE)	OAK (-O)	MDF (MDF)	CHERRY (C)	MAPLE (MP)	ALDER (ALD)	POPLAR (P)
3/4 x 3-1/4 x 6-1/2"	—	—	1BBMDF	—	—	—	—
3/4 x 3-1/2 x 6-1/2"	—	—	2BBMDF	—	—	—	—
3/4 x 2-1/2 x 5-3/4"	—	3BB-0	3BBMDF	—	—	—	—
1-1/4 x 3-1/4 x 6-1/2"	—	—	4BBMDF	—	—	—	—
1-1/4 x 3-1/2 x 6-1/2"	—	—	5BBMDF	—	—	—	—
7/8 x 2-3/4 x 6"	6BB	6BB-0	—	—	—	—	—
7/8 x 3-1/2 x 6"	7BB	7BB-0	—	—	—	—	—
7/8 x 3-3/4 x 6"	8BB	8BB-0	—	—	—	—	—
1 x 5-3/4 x 8"	9BB	9BB-0	—	—	—	—	—
1 x 2-3/4 x 6"	35BB	—	35BBMDF	35BBC	35BBMP	35BBALD	35BBP
1 x 3-1/2 x 6"	36BB	—	36BBMDF	36BBC	36BBMP	36BBALD	36BBP
1 x 3-3/4 x 6"	37BB	—	37BBMDF	37BBC	37BBMP	37BBALD	37BBP
1 x 4-1/2 x 8"	38BB	38BB-0	38BBMDF	38BBC	38BBMP	38BBALD	38BBP
1 x 5-1/2 x 8"	39BB	—	39BBMDF	39BBC	39BBMP	39BBALD	39BBP

TIP

When ordering Base Blocks, order at least 1/4" wider than the casing being used.

(Base Blocks should be thicker than the casing and base being used.)



Rosette Base Block without Edge Detail

DIMENSION	POPLAR (PAINTGRADE)	OAK (-O)	MDF (MDF)	CHERRY (C)	MAPLE (MP)	ALDER (ALD)	POPLAR (P)
7/8 x 2-3/4 x 6"	14BB	14BB-0	—	—	—	—	—
7/8 x 3-1/2 x 6"	15BB	15BB-0	—	—	—	—	—
7/8 x 3-3/4 x 6"	16BB	16BB-0	—	—	—	—	—
1 x 2-3/4 x 6"	40BB	40BB-0	40BBMDF	40BBC	40BBMP	40BBALD	40BBP
1 x 3-1/2 x 6"	41BB	41BB-0	41BBMDF	41BBC	41BBMP	41BBALD	41BBP
1 x 3-3/4 x 6"	42BB	42BB-0	42BBMDF	42BBC	42BBMP	42BBALD	42BBP
1 x 4-1/2 x 8"	43BB	43BB-0	43BBMDF	43BBC	43BBMP	43BBALD	43BBP
1 x 5-1/2 x 8"	44BB	44BB-0	44BBMDF	44BBC	44BBMP	44BBALD	44BBP



Fluted Rosette Base Block

DIMENSION	POPLAR (PAINTGRADE)	OAK (-O)
7/8 x 3-3/4 x 7"	18BB	18BB-0



Plain Springfield Base Block w/Edge Detail

DIMENSION	POPLAR (P)	OAK (-O)	MDF (MDF)
1 x 4-1/2 x 8"	38BB	38BB-0	38BBMDF



Colonial Base Block w/Rosette

DIMENSION	POPLAR (PAINTGRADE)	OAK (-O)
1 x 4-1/2 x 8"	185BB	185BB-0
1 x 5-1/2 x 8"	186BB	186BB-0
1 x 3 x 5"	192BB	192BB-0
1 x 4 x 7"	193BB	193BB-0





Base Plinth Blocks

(items are approximate scale only)

ⓘ Base blocks should be 1/4"-1" wider than casing and 1/2"-2" taller than base.

NOW AVAILABLE IN: Poplar, Oak, MDF, Cherry, Maple & Alder

	Colonial Base Block						
	DIMENSION	POPLAR (PAINTGRADE)	OAK (-O)	MDF (MDF)	CHERRY (C)	MAPLE (MP)	ALDER (ALD)
	7/8 x 2-3/4 x 6"	10BB	10BB-0	—	—	—	—
	7/8 x 5-3/4 x 8"	11BB	11BB-0	—	—	—	—
	7/8 x 3-3/4 x 6"	12BB	12BB-0	—	—	—	—
	7/8 x 3-1/2 x 6"	13BB	13BB-0	—	—	—	—
	3/4 x 2-1/2 x 5-3/4"	21BB	21BB-0	—	—	—	—
	1 x 3-1/4 x 6-1/2"	22BB	22BB-0	—	—	—	—
	1 x 3-1/2 x 6-1/2"	23BB	23BB-0	—	—	—	—
	1 x 4-1/2 x 8"	183BB	183BB-0	—	—	—	—
	1 x 5-1/2 x 8"	187BB	187BB-0	—	—	—	—
	1 x 4 x 7"	190BB	190BB-0	—	—	—	—
	1 x 3 x 5"	191BB	191BB-0	—	—	—	—

	IEE Base / Craftsman Base Block						
	DIMENSION	POPLAR (PAINTGRADE)	OAK (-O)	MDF (MDF)	CHERRY (C)	MAPLE (MP)	ALDER (ALD)
	1-1/4 x 4-1/4 x 6-3/4"	PR30BB (primed)	—	—	—	—	30BBALD

	Colonial Base Block					
	DIMENSION	OAK (-O)	MDF (MDF)	MAPLE (MP)	ALDER (ALD)	POPLAR (PAINTGRADE)
	1 x 2-3/4 x 6"	194BB-0	194BBMDF	194BBMP	194BBALD	194BB
	1 x 3-1/2 x 6"	195BB-0	195BBMDF	195BBMP	195BBALD	195BB
	1 x 3-3/4 x 6"	196BB-0	196BBMDF	196BBMP	196BBALD	196BB
	1 x 4-1/2 x 6"	197BB-0	197BBMDF	197BBMP	197BBALD	197BB
	1 x 5-1/2 x 6"	198BB-0	198BBMDF	198BBMP	198BBALD	198BB

	Inside / Outside Colonial Base Corner						
	DIMENSION	POPLAR (PAINTGRADE)	OAK (-O)	MDF (MDF)	CHERRY (C)	MAPLE (MP)	ALDER (ALD)
	7/8 x 6-3/4 (inside)	IBC	IBC-0	—	—	—	—
	1-1/8 x 6-3/4 (outside)	OBC	OBC-0	—	—	—	—

Dowels / Dowel Pins

Birch Dowels					Grooved Dowel Pins			
SIZE	PART NUMBER 36" Length	PART NUMBER 48" Length	PIECES PER BUNDLE		SIZE	PART NUMBER 36" Length	PIECES PER BUNDLE	
1/8"	060	060A	100			1/8"	90DP	500
3/16"	061	061A	100			1/4"	91DP	500
1/4"	062	062A	100			5/16"	92DP	500
5/16"	063	063A	100			3/8"	93DP	500
3/8"	064	064A	50			7/16"	94DP	500
7/16"	065	065A	50			1/2"	95DP	500
1/2"	066	066A	50			3/4"	96DP	500
5/8"	067	067A	50					
3/4"	068	068A	50					
7/8"	069	069A	25					
1"	070	070A	25					
1-1/8"	071	071A	25					
1-1/4"	072	072A	25					

Screwhole Plugs

Mushroom Screwhole Plugs			
	SIZE	PART NUMBER	PIECES PER BUNDLE
	3/8"	95MSP	500
	1/2"	96MSP	500

Cupcake Screwhole Plugs (ROUND HEAD AND FLAT HEAD)			
	SIZE	PART NUMBER	PIECES PER BUNDLE
	3/8"	90CSP	500
	1/2"	91CSP	500



INTRODUCING... Mantel Surrounds p.13

Mantel shelves and surrounds can be used in a variety of different ways, as a traditional fireplace mantel or with shelf alone for decorative items or artwork. Our mantel shelves are constructed using solid oak and poplar and a more economical version constructed of MDF. This style of shelf is a “flush mount”, and bottom projection is 3-1/4”. Mantel Shelves can be painted, stained, or faux finished. Shelves are available in 2’-6’ lengths, and 11 different styles. Surrounds encase a fireplace, adding a complete detail around (top mantel & 2 sides).

MAJESTIC
Mantels





MANCM73P 7-1/4 x 5-1/2 **Large Dentil Poplar Majestic Mantels™ Shelf**



MANCM730 7-1/4 x 5-1/2 **Large Dentil Oak Majestic Mantels™ Shelf**



MANCM74P 7-1/4 x 3-15/16 **Small Dentil Poplar Majestic Mantels™ Shelf**



MANCM74-0 7-1/4 x 3-15/16 **Small Dentil Oak Majestic Mantels™ Shelf**



MANCM83 7-1/4 x 5-5/16 **Embossed/Carved Majestic Mantels™ Shelf**



MAN412P 7-1/4 x 4-9/16 **Georgian Poplar Majestic Mantels™ Shelf**

(items are approximate scale only)



MAN410MUL 9-1/4 x 6 **Large Charleston Primed MDF Majestic Mantels™ Shelf**



MAN412MUL 7-1/4 x 4-9/16 **Georgian Primed MDF Majestic Mantels™ Shelf**



MAN4120 7-1/4 x 4-9/16 **Georgian Oak Majestic Mantels™ Shelf**



MAN413MUL 7-1/4 x 4-3/16 **Charleston Primed MDF Mantels™ Shelf**



MAN423MUL 7-1/4 x 4-3/8 **Carolina Primed MDF Majestic Mantels™ Shelf**



MAN810P 7-1/4 x 4-11/16 **Imperial Poplar Majestic Mantels™ Shelf**



MANCM8810 7-1/4 x 4-5/8 **Medium Acanthus Leaf Embossed/Carved Majestic Mantels™ Shelf**

lengths available: 2', 3', 4', 5', 6'

(items are approximate scale only)



SPRGPIL-P
Poplar Majestic Mantels™ Springfield Pilaster Kit
 1x4 S4S 2EE: 3/4" x 3-1/2"
Plain Springfield Base Block w/Edge Detail:
 1 x 4-1/2" x 8"

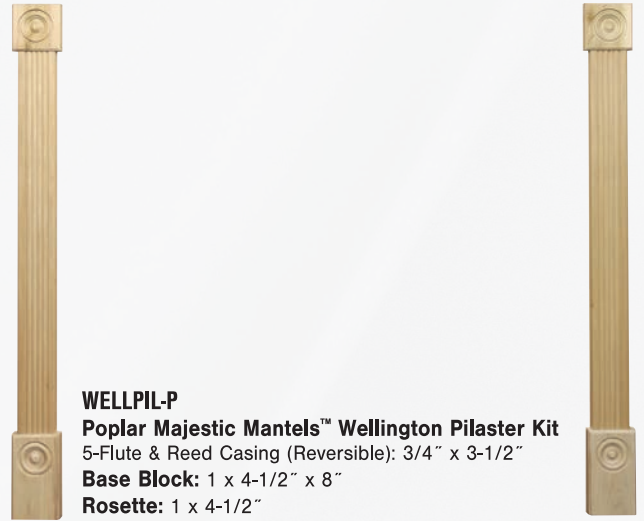

WELLPIL-P
Poplar Majestic Mantels™ Wellington Pilaster Kit
 5-Flute & Reed Casing (Reversible): 3/4" x 3-1/2"
Base Block: 1 x 4-1/2" x 8"
Rosette: 1 x 4-1/2"



SPRGPIL-O
Oak Majestic Mantels™ Springfield Pilaster Kit
 1x4 S4S 2EE: 3/4" x 3-1/2"
Plain Springfield Base Block w/Edge Detail:
 1 x 4-1/2" x 8"



WELLPIL-O
Oak Majestic Mantels™ Wellington Pilaster Kit
 5-Flute & Reed Casing (Reversible): 3/4" x 3-1/2"
Base Block: 1 x 4-1/2" x 8"
Rosette: 1 x 4-1/2"

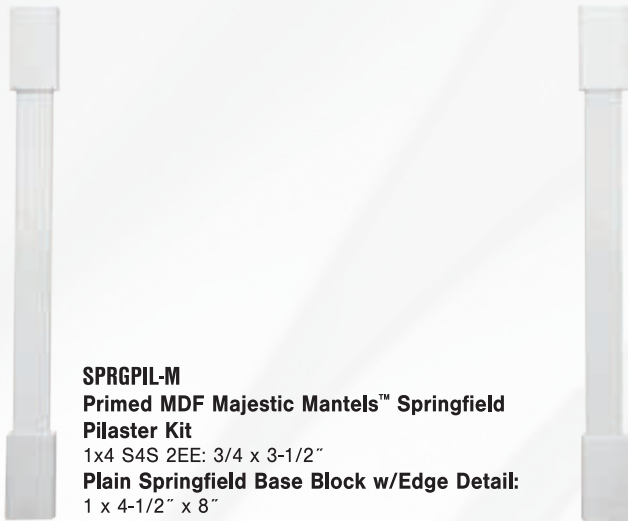

SPRGPIL-M
Primed MDF Majestic Mantels™ Springfield Pilaster Kit
 1x4 S4S 2EE: 3/4" x 3-1/2"
Plain Springfield Base Block w/Edge Detail:
 1 x 4-1/2" x 8"

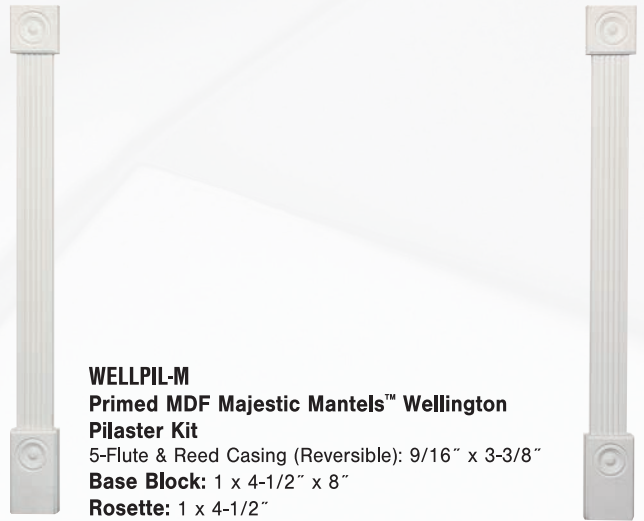

WELLPIL-M
Primed MDF Majestic Mantels™ Wellington Pilaster Kit
 5-Flute & Reed Casing (Reversible): 9/16" x 3-3/8"
Base Block: 1 x 4-1/2" x 8"
Rosette: 1 x 4-1/2"

(items are approximate scale only)



SUR-P
Poplar Majestic Mantels™ Surround Kit
Max Inner Width: 44-3/4"
Max Inner Height: 40-3/4"
Max Outer Width: 60-1/2"
Max Outer Height: 48"



SUR-O
Oak Majestic Mantels™ Surround Kit
Max Inner Width: 44-3/4"
Max Inner Height: 40-3/4"
Max Outer Width: 60-1/2"
Max Outer Height: 48"

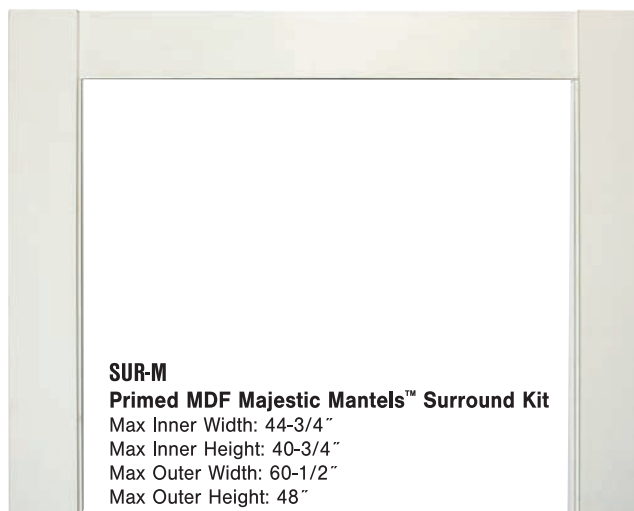

SUR-M
Primed MDF Majestic Mantels™ Surround Kit
Max Inner Width: 44-3/4"
Max Inner Height: 40-3/4"
Max Outer Width: 60-1/2"
Max Outer Height: 48"

Finishing Instructions

Majestic Mantels™ Shelves are available in MDF, Poplar, Oak, and Embossed/Carved. MDF (Medium Density Fiberboard) is made from wood fibers and is a great low cost alternative to wood. Its hard surface resists dents and scratches and its low cost will save you money on your painted applications. Poplar Majestic Mantels are made of solid clear poplar that can either be painted or stained. Oak mantels are made of clear red oak and ideal for staining. Embossed/Carved mantels are made from clear poplar. Please view the different woods with the different finish options listed.

WOOD CHOICES	PAINTABLE	STAINABLE	FAUX FINISHED
MDF	X		X
Poplar	X	X	X
Oak		X	X
Carved/Embossed	X	X	X

PAINTING

- Step 1 – Choose the color of paint you wish to use.
- Step 2 – It's a good idea to test your paint color on the backside, prior to starting.
- Step 3 – Install the mantel.
- Step 4 – Fill all nail holes with putty or painters caulk.
- Step 5 – Prime the mantel before you paint (Kilz is recommended). Use either latex or oil base paint.
- Step 6 – Paint the mantel.
- Step 7 – If necessary, paint the mantel or shelf a second time.

STAINING

- Step 1 – Choose the stain finish you wish to use (Minwax® is recommended).
- Step 2 – It is recommended that you brush a small portion of the back with the stain finish and let it dry to make sure you are happy with the color. If you will be using a polyurethane finish after the stain is applied, please apply the polyurethane and let it dry to make sure you are happy with the outcome before you start on the finished side of the mantel.
- Step 3 – Install the mantel.
- Step 4 – Stain the mantel and let dry.
- Step 5 – Fill all nail holes with putty to match the stain.
- Step 6 – Brush polyurethane on the mantel and let dry.
- Step 7 – Brush polyurethane on a second time if you feel necessary.

FAUX FINISHING

It is highly recommended that when faux finishing, marbleizing, or any other exotic finishing is to be done that you consult with a professional finisher. They can literally make all the difference on a custom project. Many of these highly skilled professionals are artisans and can really add the “wow” factor to your home.

Big Ideas



Big Ideas

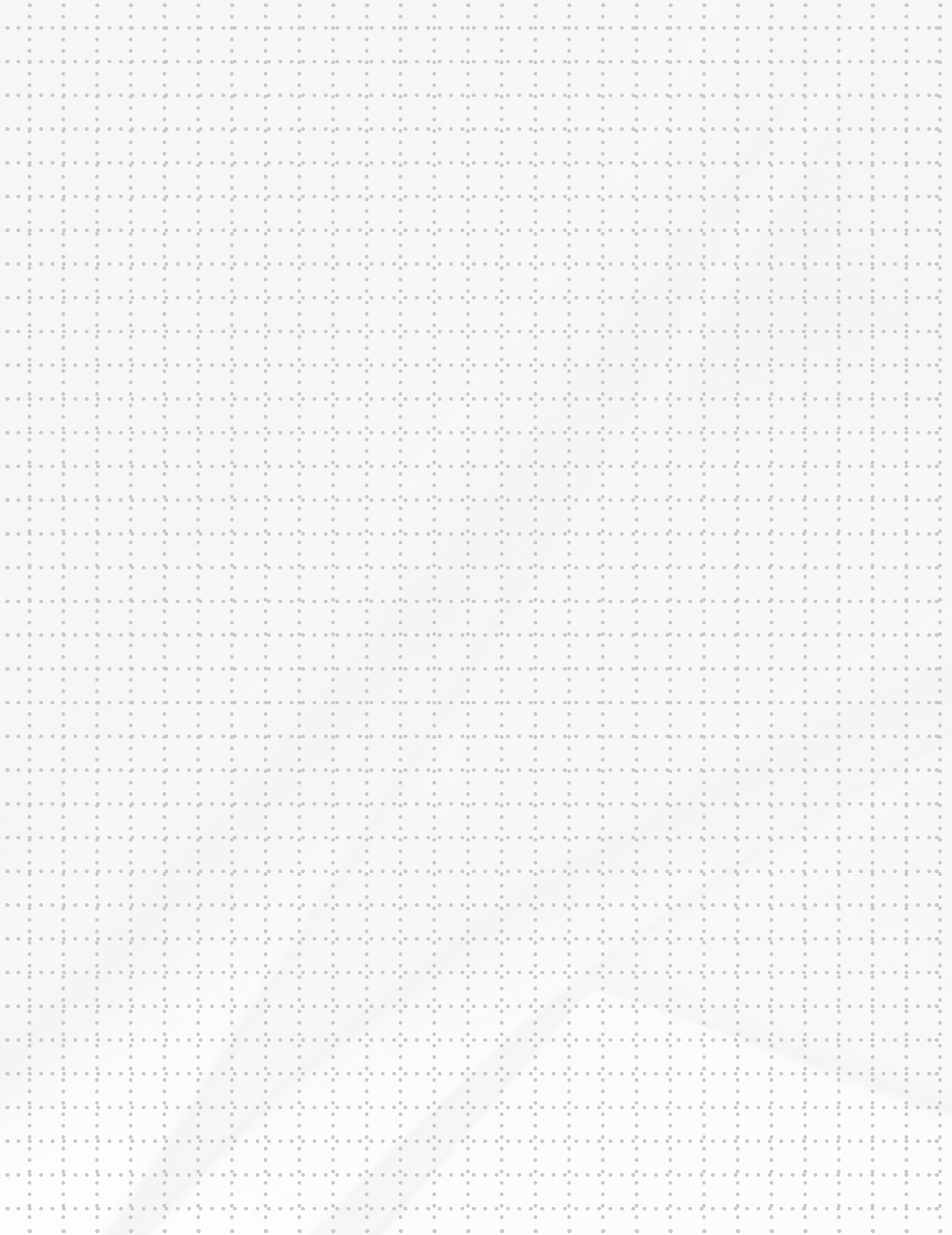

HB&G Columns & Porch Systems

THE PLACE WHERE FAMILY AND FRIENDS GREET



#1 in America, HB&G offers a wide variety of column and porch products to help you create the design that best suits your way of life. Best of all, they are the easiest to install, require little to no maintenance and come with a lifetime warranty. And with PermaCast® products you'll never have to waste time repairing or replacing them. Enjoy a beautiful, enduring structure that will improve the quality of your life for years to come.



section contents

Aluminum Columns.....	39
Architectural Columns	36
Bases / Columns	18
Capitals and Bases	26, 38
Craftsman PermaCast® Columns.....	23
Fluted Round PermaCast® Columns.....	20
Ordering PermaPorch® Railing	46
Ornamental Capitals	27
Painting Instructions.....	24
PermaCast® Columns.....	17
PermaLite® Columns	31
PermaPosts® / Perma Lamp Posts.....	41
PermaWrap® Columns	28
Porch and Deck Railing.....	44
Recessed Panel PermaCast® Columns ..	22
Rail Panels / Balusters	45
Round PermaCast® Columns	19
Square PermaCast® Columns	21

HB&G Columns & Porch Systems

I/E

DESIGN STYLES

TRADITIONAL | COLONIAL | COASTAL

**JANKA
HARDNESS**
(POUNDS-FORCE)

N/A

ORDERING

3 WAYS TO ORDER PERMAWRAP® COLUMNS

Flat Stock

- Manufactured from 3/8" Cellular PVC
- Easy Installation
- 12' Lengths use 1/2" or 3/8" Cellular PVC
- Complete Assembly Kit Included

Assembled

- Manufactured from Cellular PVC
- Fully Assembled
- 4" x 4" Pressure Treated Post Included
- Ready to Install

L-Assembly

- Manufactured from 3/8", 1/2" or 5/8" Cellular PVC
- Shipped in two "L" shaped halves
- Square Column Ready to Wrap Around an Existing Post
- Available in Plain, Fluted, Raised Panel, Recessed Panel
- Craftsman Columns Available in Plain, Raised and Recessed Panel Styles

3 WAYS TO ORDER PERMAPORCH® RAILING

Pre-built Sections

- Shipped factory assembled
- Choose length – 4', 6', or 8' sections
 - Choose desired style
 - Note rail height (36" or 42")
- Onsite trimming ensures exact fit

Do-it-Yourself Kit

- Choose length – 6' or 8'
- Choose style – Savannah or Standard
- Kit includes:
 - Savannah or Standard top rail
 - Bottom rail
 - Aluminum inserts
 - 1 1/2" x 29 1/4" square balusters
 - 6" = 14 balusters
 - 8" = 18 balusters
 - Assembly and installation hardware
 - Support block

Individual Components

- Your design; Mix and match components
- Complete rail system requires the following:
 - Top rail – Standard or Savannah
 - Top insert – aluminum, 8', 10', 12'
 - Balusters – 28-7/8", 32", 36" and 10"
 - Bottom rail
 - Bottom insert: aluminum, 8', 10', 12'
 - Support block
 - Fastening kit

HELPFUL HINTS

* ORNAMENTAL CAPITALS

When installing a round Fiberglass column with an ornamental capital, subtract the "T" dimension (distance from top of ornament to top of neck mold) and add the height of the ornamental capital; this can lengthen or shorten the height of the column. You can find the "T" dimension in the products brochure.

* REQUIRED LOADING

Ensure concentric loading of the column. 100% of bottom must contact substrate and 75% of top must contact soffit.

* HAND RAIL

When attaching hand rails or corner irons to round or square PermaCast columns, holes must be pre-drilled.

* CAP AND BASE

Light sanding may be needed for correct fitting of base.

* Columns are not designed to be set into masonry.

* Do not fill with concrete. Concrete can be used with a barrier such as Sonatube. Leave minimum 1/2" gap to allow for expansion and contraction of the concrete.

* Columns are not designed to be used in a free standing application. If used in free standing applications a structural support must be used.

PAINTING

Round & Square PermaCast® Columns

- 1 Rinse
- 2 Prime with top quality exterior latex primer, or use an oil-based primer in accordance with paint manufacturer's instructions. A light coat of primer should be applied and allowed to cure fully.
- 3 Paint evenly with several light coats over column with a high quality exterior latex or oil-base (if primer is used) in accordance with paint manufacturer's instructions.

Do not paint PermaCast® columns using dark colors (dark colors are considered any color that falls within the L value of 56 to 0). L is a measure of lightness of an object and ranges from 0 (black) to 100 (white).

PermaWrap® Columns

- 1 Caulk where required using Siroflex brand Sealant and Adhesive provided by manufacturer. Putty any holes using acrylic putty or caulk.
- 2 Lightly sand or scuff surface of column.
- 3 Clean surface of column to remove any dirt or hand oil residue with light detergent and water, denatured alcohol, or window cleaner. Be sure to remove soap residue with clean water.
- 4 Apply one coat of 100% acrylic exterior primer and one or more finish coats of 100% acrylic exterior paint.

Do not paint columns using dark colors (dark colors are considered any color that falls within the L value of 56 to 0). L is a measure of lightness of an object and ranges from 0 (black) to 100 (white).



ALWAYS TEST TO MAKE SURE YOUR MEASURING TOOLS ARE ACCURATE. IF YOU ARE WORKING WITH A HELPER, TAKE A MEASUREMENT WITH ONE TOOL WHILE YOUR HELPER MEASURES WITH ANOTHER AND COMPARE YOUR RESULTS.



The PERMACast® Column Collection

- Weather Proof
- Insect Proof
- Load Bearing
- Low Maintenance
- Ready to Prime and Paint
- Limited Lifetime Warranty
- Custom Fluting Available
- Factory PermaPriming Available



24" Round PermaCast® Columns with Roman Corinthian Capitals

Architectural Accuracy

In the first century B.C., Vitruvius, a Roman architect and engineer, wrote what has become the most influential work on classic form. In it, he elaborates on the discovery by the ancient Greeks of entasis, a gradual tapering of the upper two-thirds of the round column which offsets the undesirable illusion from eye level that the column shaft grows larger as it ascends. HB&G round columns hold true to this classic form.



A Column To Fit Any Look

(items are approximate scale only)

HB&G PermaCast® Columns are available in round or square. The round columns are fluted, or plain, with or without the classic tapering of the upper two-thirds of the column. Square columns are available in a variety of styles as well, including plain or fluted, applied panel, recessed panel, or the craftsman style column.

The PermaCast® capitals and bases are made from durable low-maintenance materials, and like the columns, they maintain architectural authenticity and historical accuracy.



Round Plain (page 19)

Round Fluted (page 20)

Round No-Taper (page 20)

Square Fluted (page 21)

Square Recessed Panel (page 22)

Square Applied Panel (page 21)

Plain Square (page 21)

Craftsman (page 23)



Tuscan Cap (Round)



Tuscan Cap (Square)



Doric Cap (Round)



Colonial Cap (Round)



Attic Base (Round)



Crown Cap or Base



Tuscan Base Poly/Fiberglass (Round)



Tuscan Base (Square)



Doric Base (Round)



Colonial Base (Round)



Attic Base (Square)



PermaTuff™ Tuscan Base



Roman Ionic



Greek Ionic



Temple of the Winds



Roman Corinthian



Scamozzi



Colonial Cap (Square)



Roman Ionic (Square)



Greek Ionic (Square)



Temple of the Winds (Square)



Roman Corinthian (Square)



Scamozzi (Square)



Colonial Base (Square)

Round PERMACast® Columns

ROUND PERMACAST® COLUMN DIMENSIONS (IN INCHES)*

COL. SIZE	A	B	C	D	E	F	G	J	K	L	O	N	R	T	LENGTHS AVAIL. (ft.)
6"	5 5/8"	4 3/8"	9"	1 1/8"	1 1/8"	3/8"	3/4"	1 1/4"	1 1/8"	8"	1"	6 1/4"	3 3/8"	4 7/8"	4, 6, 8
8"	7 7/8"	6 1/4"	10 1/2"	1 7/8"	1 3/4"	3/4"	3/4"	1 1/4"	1 1/2"	9 1/4"	1 1/2"	2 1/4"	4 3/8"	4 1/2"	5, 6, 8, 10, 12
10"	9 3/8"	8 1/8"	13 1/8"	2 3/8"	2 1/8"	3/4"	3/4"	1 1/4"	1 3/4"	11 1/4"	3/8"	2 1/4"	5 1/4"	5"	6, 8, 9, 10, 12
12"	11 1/8"	9 3/8"	16 1/2"	2 7/8"	2 3/4"	7/8"	13/16"	1 3/4"	2 1/4"	13 3/4"	3/4"	2 3/8"	6 1/8"	5 3/4"	6, 8, 9, 10, 12, 14, 16, 18
14"	13 3/8"	11 3/8"	19 1/2"	3 3/8"	3 1/8"	1 1/8"	7/8"	2"	2 3/8"	17"	7/8"	2 3/8"	7 3/8"	7"	8, 9, 10, 12, 14, 16, 18
16"	15 1/4"	13 3/8"	22 3/8"	4"	3 1/2"	1 1/8"	1"	2 1/4"	3"	19 1/4"	1"	3"	8 3/8"	8"	8, 10, 12, 14, 16, 18, 20
18"	17 1/2"	15 3/8"	24 3/4"	4"	4"	1 1/8"	1 1/8"	2 3/4"	3 3/8"	22 3/8"	1 1/2"	10 3/4"	9 3/8"	8 3/4"	10, 12, 14, 16, 18, 20, 22, 24, 26
20"	19 1/2"	17 1/8"	27"	4 1/4"	4 1/2"	2"	1 7/16"	2 3/8"	3 3/8"	24 1/2"	1 1/2"	10 3/4"	11 1/4"	9"	10, 12, 14, 16, 18, 20, 22, 24
22"	21 1/8"	19 1/4"	30 3/4"	5 3/8"	4 3/4"	2"	1 7/8"	3"	3 3/4"	27 1/2"	1 1/2"	10 3/4"	12 1/4"	10 1/4"	16, 18, 20, 22, 24, 26
24"	23 3/8"	21 1/4"	33 1/2"	5 7/8"	5 1/4"	2 3/16"	2 3/16"	3 1/2"	4 1/8"	30 1/2"	1 1/2"	10 3/4"	13 1/8"	11 1/16"	12, 14, 16, 18, 20, 22, 24, 26, 28, 30
28"	28"	24 3/4"	38"	6 3/4"	6"	2 3/4"	2 3/8"	3 3/4"	4 3/4"	33 3/4"	1 1/2"	10 3/4"	15 1/2"	11 3/4"	20, 22, 24, 26, 28
30"	29 3/8"	26 1/2"	41 1/8"	6 1/2"	5 7/8"	2 1/2"	3 1/16"	4"	4 3/8"	38 1/4"	1 1/2"	10 3/4"	14 3/8"	14 3/8"	20, 22, 24, 26, 28, 30

*There may be a variance of up to 1/4" in all dimensions. Fluted columns available in all diameters. See page 14 for Parallel dimensions. See page 16 for Ornamental Capital dimensions. Standard Fluted Column (Fluted in mold)

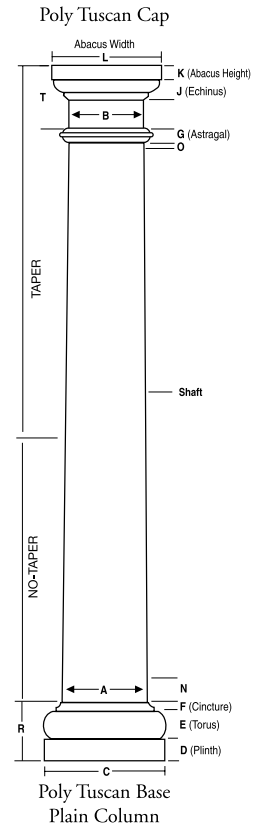

Poly Tuscan Base Plain Column

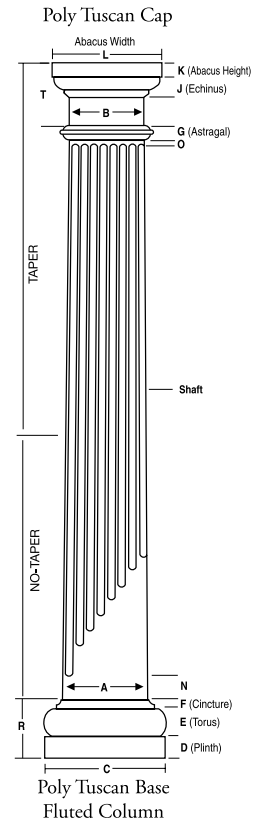

Poly Tuscan Base Fluted Column

COLUMN-LOC™

Column-Loc™ creates a continuous connection from floor to beam/header without the expense of splitting and reattaching the column. This labor saving product is easy to install and delivers wind uplift resistance especially important in coastal and high wind areas. Currently available for 8 and 10" round (tapered and no-taper) and square PermaCast® columns. Kits are available with and without threaded rod.



PLUMB-FIT®

To make installation even easier our 6-12" round and square poly Tuscan Cap and Base Sets with flashing cap now come with the Plumb-Fit® installation system included.

SPLIT COLUMN ASSEMBLY KITS (FLANGE KIT)

HB&G offers a split column assembly kit that utilizes a mechanical fastening system for easy and secure assembly. This kit can be purchased separately when ordering a factory split column or they can be ordered pre-installed on factory split columns. This kit is available on select sizes.

ROUND PERMACAST® INSIDE DIMENSIONS

Inside dimension may vary up to 1/8". Splitting a column will decrease inside dimension 1/8".

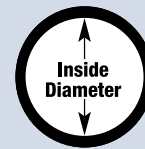

COLUMN SIZE	TOP I.D.	BOT I.D.
6"	3 3/8"	4 1/8"
8"	5 1/2"	6 1/8"
10"	7 1/8"	8 1/8"
12"	8 3/8"	10 1/8"
14"	10 1/8"	12 1/8"
16"	12 1/8"	15"
18"	14 1/8"	16 1/8"
20"	16 1/8"	19"
22"	18 1/4"	20 1/8"
24"	20 1/4"	22 1/8"
28"	22"	26 1/2"
30"	25 1/4"	28 1/8"



Fluted Round PermaCast® Columns

(items are approximate scale only)

Fluted Round **PERMA**Cast® Columns

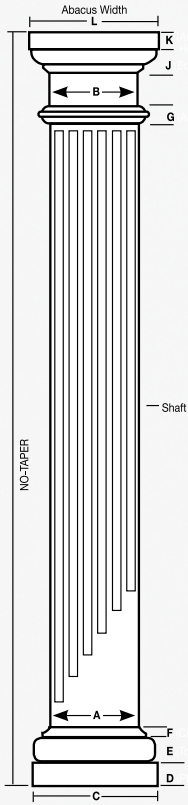

PermaCast® No-Taper column with Poly Tuscan cap and base

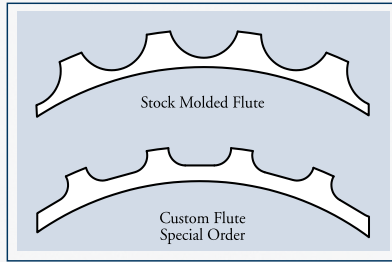

HB&G OFFERS TWO DISTINCTIVE TYPES OF FLUTES.

Stock Molded Flute: Available in diameters of 8" x 8' – 16" x 12' columns (See price guide for specific lengths available.) The stock molded flute is part of the manufacturing process and cannot be altered.

Custom Flute: The custom flute is milled after the column is manufactured and can be modified to your specific length. All round PermaCast® columns, 6" x 4' – 30" x 30', are available with an optional custom flute. (Call a customer service representative for pricing and lead times.) Adjusted Flutes available.

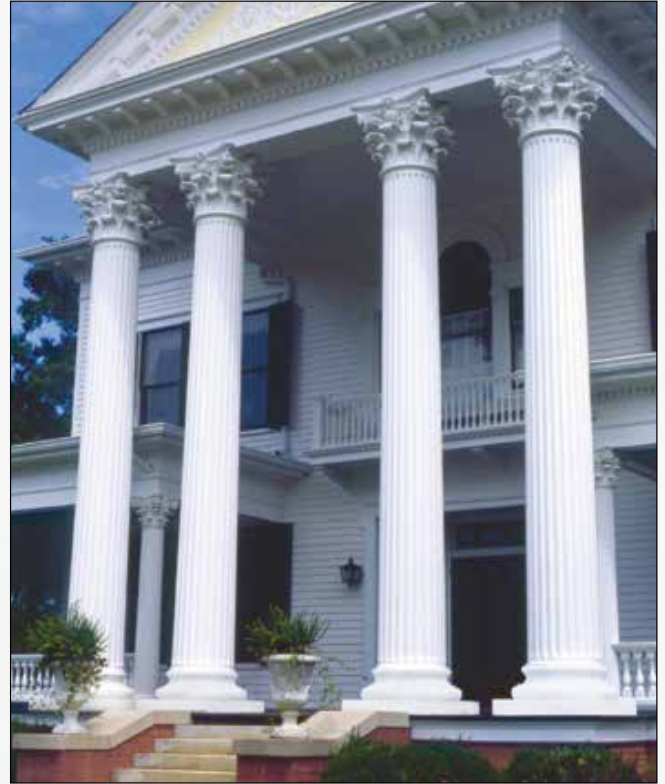

Round No-Taper **PERMA**Cast® Columns

ROUND NO-TAPER PERMACAST® COLUMN DIMENSIONS (IN INCHES)

Col. Size	A	B	C	D	E	F	G	J	K	L	Lengths Avail. (ft.)
8"	7 ⁵ / ₈ "	7 ⁵ / ₈ "	10 ¹ / ₂ "	1 ⁷ / ₈ "	1 ³ / ₄ "	3 ⁴ / ₈ "	3 ⁴ / ₈ "	1 ¹ / ₄ "	1 ¹ / ₂ "	10 ⁵ / ₈ "	6,8,9,10
10"	9 ⁵ / ₈ "	9 ⁵ / ₈ "	13 ¹ / ₈ "	2 ³ / ₈ "	2 ¹ / ₈ "	3 ⁴ / ₈ "	3 ⁴ / ₈ "	1 ¹ / ₄ "	1 ³ / ₄ "	12 ¹³ / ₁₆ "	6,8,9,10,12
12"	11 ⁵ / ₈ "	11 ⁵ / ₈ "	16 ¹ / ₂ "	2 ⁷ / ₈ "	2 ³ / ₈ "	7 ¹ / ₈ "	1 ³ / ₁₆ "	1 ³ / ₄ "	2"	15 ⁷ / ₈ "	6,8,9,10,12
14"	13 ⁵ / ₈ "	13 ⁵ / ₈ "	19 ¹ / ₂ "	3 ³ / ₈ "	3 ¹ / ₈ "	1 ¹ / ₈ "	7 ¹ / ₈ "	2 ¹ / ₄ "	3"	19 ¹ / ₈ "	6,8,9,10,12,14
16"	15 ³ / ₄ "	15 ³ / ₄ "	22 ¹ / ₈ "	4"	3 ¹ / ₂ "	1 ¹ / ₈ "	1"	2 ¹ / ₄ "	2 ³ / ₄ "	22"	6,8,9,10,12,14,16,18,20
18"	17 ¹ / ₂ "	17 ¹ / ₂ "	24 ⁵ / ₈ "	4"	4"	1 ⁵ / ₈ "	1 ¹ / ₈ "	2 ³ / ₄ "	3 ¹ / ₈ "	24 ⁵ / ₈ "	6,8,9,10,12,14,16,18,20
24"	24"	24"	33 ¹ / ₂ "	5 ³ / ₄ "	5 ¹ / ₄ "	2 ³ / ₁₆ "	2 ³ / ₁₆ "	3 ¹ / ₂ "	4 ¹ / ₈ "	33 ³ / ₈ "	8,10,12,14,16,18,24

Neck mould not included.
Flashing and Installation Kit not available with No-Taper Tuscan cap and base sets.

NECK MOULD FOR NO-TAPER COLUMN – SOLD SEPARATELY

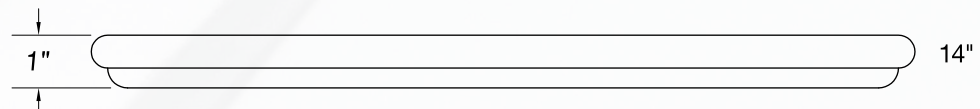
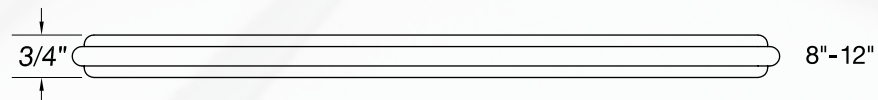

PermaCast® Plain No-Taper column with Poly Tuscan cap and base



Square PERMACast® Columns

SQUARE PERMACAST® INSIDE DIMENSIONS

Inside dimensions may vary up to 1/8".
Splitting a column will decrease inside dimension 1/8".

COL. SIZE	INSIDE
6"	5 1/4"*
8"	6 7/8"
10"	9"
12"	11"
14"	12"
16"	14 3/4"

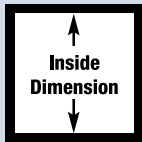

*Inside is Round

PANEL MOULDING FOR SQUARE PERMACAST®

Length: 8'
No. 54502
1/2" x 1"

Length: 10'
No. 54503
1" x 1"

Length: 10'
No. 54504
3/4" x 1"

Length: 10'
No. 54505
3/4" x 1 5/16"

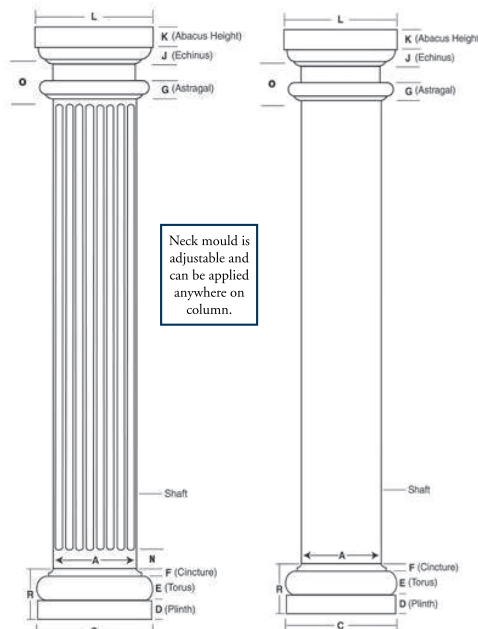

PermaCast® Square Column shown fluted with Poly Tuscan Cap and Base.

PermaCast® Square Column shown plain with Poly Tuscan Cap and Base.

Neck mould is adjustable and can be applied anywhere on column.

Plumb-Fit®

To make installation even easier our 6-12" round and square poly Tuscan Cap and Base Sets with flashing cap now come with the Plumb-Fit® installation system included.

Column-Loc™

Column-Loc™ creates a continuous connection from floor to beam/header without the expense of splitting and reattaching the column. This labor saving product is easy to install and delivers wind uplift resistance especially important in coastal and high wind areas. Currently available for 8 and 10" round (tapered and no-taper) and square PermaCast® columns. Kits are available with and without threaded rod.

SQUARE PERMACAST® COLUMN DIMENSIONS (In Inches)*

Column Size	A	C	D	E	F	G	J	K	L	N	O	R	Lengths Available (ft.)
6"	6"	9 3/8"	1 1/8"	1 1/8"	3/8"	1"	1 1/4"	1 3/8"	9 3/8"	N/A	N/A	3 5/8"	6,8,9,10
8"	8"	11 1/8"	1 3/8"	1 3/4"	5/8"	1"	1 3/8"	1 3/8"	10 1/16"	4"	3 1/8"	4 1/4"	6,8,9,10,12
10"	10"	13 1/16"	2 1/8"	2 3/16"	3/4"	1"	1 1/4"	1 13/16"	12 3/4"	4"	4 1/8"	5 1/16"	51",6,8,9,10,12,14,16
12"	12"	16 1/16"	2 13/16"	2 3/8"	7/8"	1"	1 3/4"	2 1/16"	16 1/16"	N/A	N/A	6 1/16"	8,9,10,12,14,16,18
14"	14"	19 3/8"	3 1/8"	2 7/8"	1 1/16"	1 1/8"	2 1/16"	2 1/2"	19 1/16"	N/A	N/A	7 9/16"	8,10,12
16"	16"	22 1/8"	3 7/8"	3 3/8"	1 1/8"	1 1/8"	2 3/8"	2 3/4"	21 1/2"	N/A	N/A	8 3/8"	8,10,12,14,16,18,20

☐ Fluted Square.

*There may be a variance of up to 1/4" in all dimensions.

See page 27 for Ornamental Capital dimensions.

Versatility of Square Columns

The design and versatility of an HB&G square column has enhanced its popularity with today's architects. The HB&G Square PermaCast® column lineup includes plain, recessed panel, and fluted styles. An unlimited combination of styles can be achieved by various uses of the panel moulding, neck moulding, and caps and bases. Additionally, the square column is not tapered and can be cut to any height without affecting the fit of the caps and bases.



Square Recessed PermaCast® Columns

(items are approximate scale only)

Recessed Panel **PERMA**Cast® Columns

RECESSED PANEL INSIDE DIMENSION

Inside dimension may vary up to 1/8".
Splitting a column will decrease inside dimension 1/8".

Col. Size	Inside
8"	5-5/8"
10"	7-1/2"
12"	9-1/2"
14"	11"

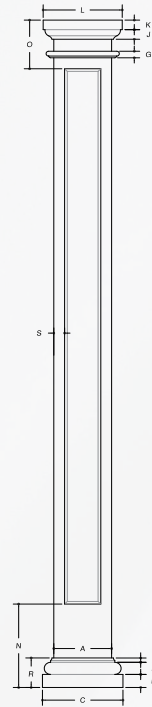
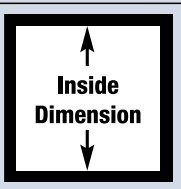

Neck mould is adjustable and can be applied anywhere on column.

Square Column with Poly Tuscan Cap and Base

SQUARE RECESSED PANEL PERMACAST® COLUMN DIMENSIONS (In Inches)*

Column Size	A	C	D	E	F	G	J	K	L	N	O	R	S	Recess Depth	Lengths Available (ft.)
8"	8"	11 1/8"	1 7/8"	1 3/4"	5/8"	1"	1 3/8"	1 3/8"	10 5/16"	12"	7"	4 1/4"	1 1/2"	1/2"	8,9,10
10"	10"	13 3/16"	2 1/4"	2 3/16"	3/4"	1 1/4"	1 1/4"	1 13/16"	12 3/4"	14 1/2"	8 1/2"	5 3/16"	1 1/2"	1/2"	8,9,10
12"	12"	16 3/16"	2 13/16"	2 3/8"	7/8"	1 1/4"	1 3/4"	2 1/16"	16 1/16"	18"	10 1/2"	6 1/16"	2 1/4"	9/16"	8,9,10,12,14
14"	14"	19 3/8"	3 3/8"	2 7/8"	1 1/16"	1 1/8"	2 1/16"	2 1/2"	19 1/16"	21"	12 1/4"	7 7/16"	2 3/8"	3/4"	8,10,14

See page 16 for Ornamental Capital dimensions.

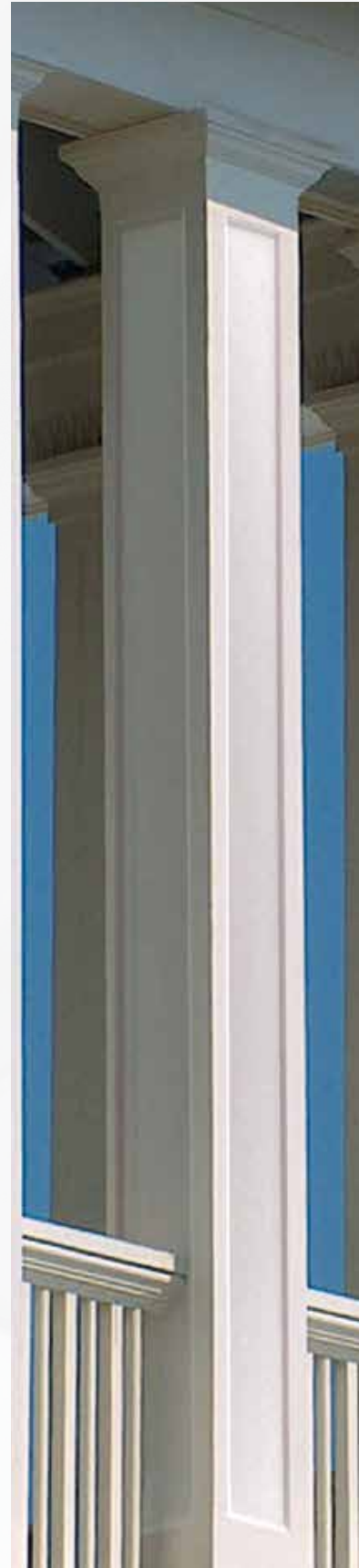

(items are approximate scale only)

Craftsman PermaCast® Columns

CRAFTSMAN PERMACAST® COLUMN

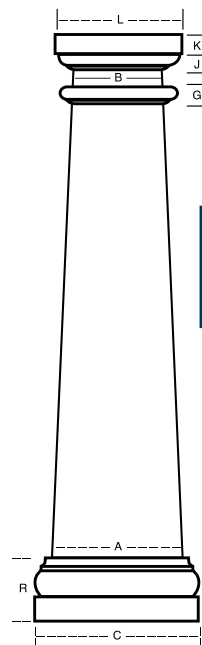

Neck mould is adjustable and can be applied anywhere on column.*



CRAFTSMAN INSIDE DIMENSION
 Inside dimension may vary up to 1/8".
 Splitting a column will decrease inside dimension 1/8".

Column Size	Top	Bottom	
10" x 5 1/2"	4 1/2"	9"	
10 1/4" x 7 1/2"	6 1/2"	9 1/4"	
10" x 8"	6 1/2"	8 1/2"	
12" x 10"	9"	11"	
14" x 12"	11"	13"	
16" x 9"	8"	15"	

CRAFTSMAN COLUMN DIMENSIONS (IN INCHES)

	A	B	C	D	E	F	G	J	K	L	R	LENGTH
10" x 5 1/2"	10"	5 1/2"	13"	2 1/2"	2 3/8"	1 1/16"	1"	1 3/8"	1 3/8"	9 5/8"	5 7/8"	66"
10 1/4" x 7 1/2"	10 1/4"	7 1/2"	13 1/2"	2 3/8"	2 1/4"	3/4"	1"	1"	1"	10 1/4"	5 3/8"	7'
10" x 8"	9 1/2"	7 1/2"	12 3/4"	2 3/8"	2 1/8"	3/4"	1"	1"	1 3/8"	10 1/4"	5 1/4"	66"
12" x 10"	12"	10"	16 9/16"	2 1/2"	2 1/2"	1 1/16"	1"	1 3/8"	1 3/8"	12 3/4"	6 1/16"	6', 10'
14" x 12"*	14"	12"	18 3/4"	3 3/8"	3"	1"	1"	1 5/8"	2"	17 1/8"	7 3/8"	9'
16" x 9"	16"	9"	18 3/4"	2 1/2"	2 1/2"	1 1/16"	1"	1 3/8"	1 3/8"	13 1/4"	6 1/16"	58"
16" x 9"	16"	9"	19 1/16"	2 1/2"	2 1/2"	1 1/16"	1"	1 3/8"	1 3/8"	13 1/4"	6 1/16"	6', 8'
16" x 12"	15 1/4"	11 1/2"	21 1/2"	3 7/8"	3 5/16"	1 3/16"	1"	1 3/8"	2"	15 1/4"	8 7/16"	58", 6', 8'

*Has 1/3" to 2/3" taper.
 NOTE: Neck mould is not applied. Flashing and Installation Kit is not available for Craftsman Columns with Poly Tuscan cap and base sets.



Painting Instructions

Painting Instructions

Painting instructions for round and square PermaCast® columns:

- Rinse and allow to dry completely.
- Prime with high quality exterior latex primer or use an oil-based primer in accordance with paint manufacturer's instructions. A light coat of primer should be applied and allowed to cure fully.
- Paint evenly with several light coats over column with a high quality exterior latex or oil-based (if primer is used) paint in accordance with paint manufacturer's instructions.
- Do not paint PermaCast® columns using dark colors (dark colors are considered any color that falls within the L value of 56 to 0). L is a measure of lightness of an object and ranges from 0 (black) to 100 (white).

Tips

- ✓ When ordering an ornamental capital order the appropriate base for the column.
- ✓ Ornamental capitals for square PermaCast® slide over the shaft and do not use a plug. These ornamental capitals will not lengthen or shorten the height of the column.
- ✓ When installing an ornamental capital on fluted, recessed panel, or square columns, the capital slides over the shaft. The taller capitals will cover the flutes and require additional caulking to finish.
- ✓ Verify exact opening measurement prior to ordering column length.
- ✓ When installing a PermaCast® column, verify concentric loading of column. 100% of bottom must contact substrate and 75% of top must contact soffit.
- ✓ When attaching hand rails or corner iron to PermaCast® columns, holes must be pre-drilled before applying screws.
- ✓ When ordering panel moulding for square PermaCast® columns, make sure to order enough for four sides of the column.
- ✓ Split columns are left partially intact. Cut with masonry or carbide tip blade.
- ✓ Custom split columns, caps, and bases are nonrefundable.

Splitting Options

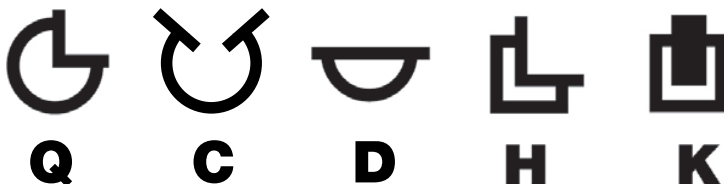

HB&G's number one goal is finding ways that we can save you time and make your life easier.

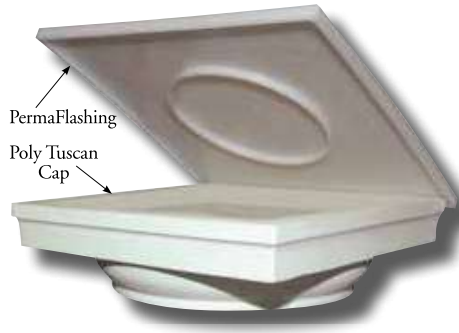

PermaCast® PermaFlashing and Installation Kit

The PermaCast® flashing with Plumb-Fit® and installation kit is available in selected Tuscan cap and base sets.*

This innovation will not only save time but will keep the elements out of the column and secure the top and bottom of the column.

*Not available in Tuscan cap and base sets for Craftsman, No-taper, PermaLite®, and Wood columns.



Round PermaCast® Porch Installation Bracket

The HB&G Porch Installation Bracket includes the bracket and all required hardware. The bracket fits 20"- 30" Plain Round PermaCast® Columns and will secure a 2nd story porch to our PermaCast® Columns. Three brackets are required for each column.



PARALLEL DIMENSIONS			
Column Size	Parallel Dim.	Column Size	Parallel Dim.
6x4	0"	18x18	60"
6x6	8"	18x20	84"
6x8	32"	18x22	49"
8x5	12"	18x24	73"
8x6	24"	18x26	97"
8x8	32"	20x10	0"
8x9	28"	20x12	0"
8x10	40"	20x14	0"
10x6	8"	20x16	4"
10x8	32"	20x18	28"
10x9	28"	20x20	52"
10x10	40"	20x22	76"
10x12	48"	20x24	100"
12x6	8"	22x16	45"
12x8	32"	22x18	69"
12x9	8"	22x20	93"
12x10	32"	22x22	53"
12x12	48"	22x24	77"
12x14	59"	22x26	101"
12x16	40"	24x12	21"
12x18	73"	24x14	45"
14x8	32"	24x16	69"
14x9	12"	24x18	93"
14x10	24"	24x20	75"
14x12	48"	24x22	99"
14x14	27"	24x24	123"
14x16	51"	24x26	77"
14x18	75"	24x28	101"
16x8	16"	24x30	125"
16x10	40"	28x20	20"
16x12	29"	28x22	44"
16x14	53"	28x24	68"
16x16	36"	28x26	92"
16x18	60"	28x28	116"
16x20	84"	30x20	56"
18x8	0"	30x22	80"
18x10	16"	30x24	140"
18x12	40"	30x26	75"
18x14	48"	30x28	99"
18x16	36"	30x30	123"

Column Size	Bottom Diameter
6x4	5 ³ / ₈ "
18x8	17 ¹ / ₄ "
20x10	18 ¹¹ / ₁₆ "
20x12	18 ⁵ / ₁₆ "
20x14	19 ¹ / ₄ "



PERMA Capitals and Bases

About EL & EL Capitals & Bases

EL & EL manufactures capitals and bases, made from high grade urethane, that are extremely strong, dense, and durable. Use product codes with a '-E' to ensure ordering a column system using HB&G's superior column shafts with EL & EL's high grade urethane capitals and bases. Please note that EL & EL capitals do not include the cap flashing. Please order Round Flashing Caps (RFC) when a flashing cap is desired with an EL & EL capital.

CAPITAL AND BASE OPTIONS

Most capitals and bases for PermaCast® columns are made of polyurethane and are decorative. The shaft fits through the center of the capital and base and does not alter the height of the shaft. Ornamental capitals for round PermaCast® columns will alter the height of the shaft.

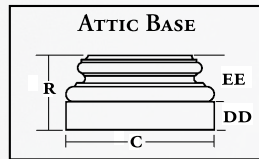

TUSCAN CAP AND BASES

The Tuscan style is standard and best complements the PermaCast® column. The Tuscan is available for all round and square shafts. For dimension see pages 26, 27 and 38.

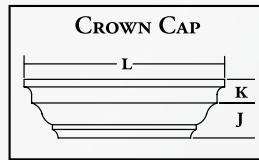

ORNAMENTAL CAPITAL

Five styles of ornamental capitals are available for all round and square shafts. Using an ornamental capital with a round PermaCast® shaft will alter the height of the shaft. Ornamental capitals do not alter the height of the shaft when used on a square PermaCast® Column.

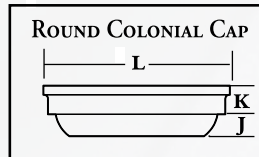

ATTIC BASE

Attic Bases are used for a more ornate look and come in 1 or 2 pieces depending on their size.

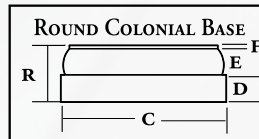

COLONIAL CAP AND BASE

Referred to as our low profile cap and base, the Colonial are designed specifically for use in applications where railing will be attached to the column. Available for PermaCast® round and square shafts 6"-12".

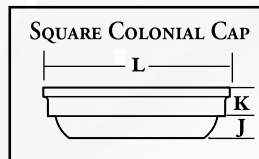

FIBERGLASS BASE

The fiberglass base is manufactured from the same materials as the shaft and is available for Round PermaCast® shafts 8"-14" only. It is designed to be used in high traffic areas.

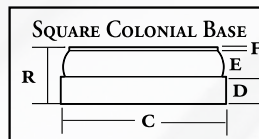

PERMA TUFF® CAP AND BASE

A durable hard shell base combined with a poly cap. Designed for high traffic applications. Available for PermaCast® round shafts 8"-12".

DIMENSIONS OF ATTIC BASE FOR ROUND AND SQUARE COLUMNS

COLUMN SIZE	ROUND ATTIC				COLUMN SIZE	SQUARE ATTIC			
	C	DD	EE	R		C	DD	EE	R
6"	8 5/16"	1 3/8"	2 3/4"	4 1/8"	6"	8 7/16"	1 3/8"	2 7/8"	4 1/4"
8"	10 1/8"	1 7/8"	3 3/4"	5 1/8"	8"	11"	1 7/8"	3 1/4"	5 1/8"
10"	13"	2 1/2"	3 3/8"	6 3/8"	10"	13 3/8"	2 3/8"	4"	6 3/8"
12"	16 1/8"	3"	4 1/2"	7 1/2"	12"	17"	2 3/4"	4 1/2"	7 1/4"
14"	19 1/4"	3 3/8"	5 3/8"	8 3/4"	N/A	N/A	N/A	N/A	N/A
16"	21 1/4"	4"	6 1/2"	10 1/2"	16"	22 3/8"	4"	6 5/8"	10 3/8"
18"	25"	4 3/8"	7 1/4"	11 5/8"	N/A	N/A	N/A	N/A	N/A
20"	27 1/16"	4 7/8"	8 1/4"	13 3/8"	N/A	N/A	N/A	N/A	N/A
22"	30 1/4"	5 3/8"	9 1/4"	14 3/8"	N/A	N/A	N/A	N/A	N/A
24"	33 1/2"	6"	10 1/4"	16 1/4"	N/A	N/A	N/A	N/A	N/A
28"	38"	6 3/4"	11 3/8"	18 1/8"	N/A	N/A	N/A	N/A	N/A
30"	41 1/4"	6 1/2"	11 1/4"	17 3/4"	N/A	N/A	N/A	N/A	N/A

CROWN CAP FOR SQUARE COLUMN DIMENSIONS

Column Size	K	J	L
6"	1 9/16"	2 5/16"	11 1/4"
8"	1 9/16"	2 5/16"	13 1/4"
10"	1 9/16"	2 5/16"	15 1/4"
12"	1 9/16"	2 5/16"	17 1/4"

COLONIAL ROUND CAP AND BASE DIMENSIONS*

Col. Size	C	D	E	F	J	K	L	R
6"	7 1/4"	1 3/8"	1 1/4"	1/4"	1"	1 1/4"	7"	2 7/8"
8"	9 1/8"	1 1/2"	1 5/16"	1/4"	1 1/16"	1 3/8"	9"	3"
10"	11 3/16"	1 1/2"	1 1/4"	1/4"	1 1/16"	1 3/8"	10 9/16"	3"
12"	13 1/8"	1 1/2"	1 1/4"	1/4"	1 1/16"	1 3/8"	12"	3"

*Low profile option.

COLONIAL SQUARE CAP AND BASE DIMENSIONS*

Col. Size	C	D	E	F	J	K	L	R
6"	8 3/8"	1 1/4"	1 1/16"	7/16"	5/8"	1"	7 5/16"	2 3/4"
8"	10 5/8"	1 1/4"	1 1/16"	7/16"	15/16"	1"	9 5/16"	2 3/4"
10"	12 3/8"	1 1/4"	1 1/16"	7/16"	15/16"	1 1/4"	12 3/8"	2 3/4"
12"	14 3/8"	1 1/4"	1 1/16"	7/16"	1"	1 3/8"	14 3/8"	2 3/4"

*Low profile option.



(items are approximate scale only)

Ornamental Capitals

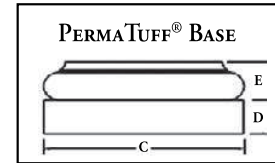
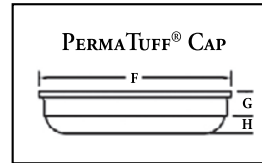
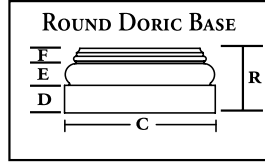
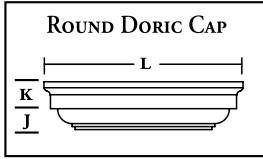

DORIC CAP AND BASE DIMENSIONS

Column Size	C	D	E	F	J	K	L	R
8"	10 ³ / ₈ "	1 ⁷ / ₈ "	1 ⁵ / ₈ "	7 ⁷ / ₈ "	1"	1 ³ / ₈ "	10"	4 ⁷ / ₁₆ "
10"	12 ⁵ / ₁₆ "	2 ³ / ₈ "	2 ¹ / ₁₆ "	1 ¹ / ₈ "	1 ¹ / ₁₆ "	1 ¹ / ₁₆ "	12 ¹ / ₂ "	5 ⁹ / ₁₆ "
12"	15 ¹ / ₂ "	2 ⁷ / ₈ "	2 ¹ / ₂ "	1 ³ / ₈ "	1 ⁹ / ₁₆ "	2"	15"	6 ¹¹ / ₁₆ "
14"	18 ¹ / ₈ "	3 ³ / ₁₆ "	2 ⁷ / ₈ "	1 ⁹ / ₁₆ "	1 ¹³ / ₁₆ "	2 ³ / ₈ "	17 ¹ / ₂ "	7 ¹³ / ₁₆ "
16"	20 ⁷ / ₈ "	3 ³ / ₄ "	3"	2 ¹ / ₄ "	1 ⁹ / ₁₆ "	2 ³ / ₄ "	20 ¹ / ₂ "	9"
18"	23 ³ / ₄ "	4"	3 ¹ / ₂ "	2 ¹ / ₂ "	1 ³ / ₄ "	3"	23 ¹ / ₈ "	10"

TUSCAN PERMATUFF® BASE AND POLY CAP DIMENSIONS

Col. Size	C	D	E	F	G	H
8"	10-1/2"	1-7/8"	2-1/2"	9-1/4"	1-1/2"	1-1/4"
10"	13-1/8"	2-3/8"	2-7/8"	11-1/4"	1-3/4"	1-1/4"
12"	16-1/2"	2-7/8"	3-1/4"	13-3/4"	2-1/4"	1-3/4"

CAPITAL DIMENSIONS FOR ROUND AND SQUARE COLUMNS (IN INCHES)

Size of Columns (Diameter at bottom of shaft)	6"		8"		10"		12"		14"		16"		18"		20"		22"		24"		28"		30"		
	ROUND	SQUARE	ROUND	SQUARE	ROUND	SQUARE	ROUND	SQUARE	ROUND	SQUARE	ROUND	SQUARE	ROUND	SQUARE	ROUND	SQUARE	ROUND	SQUARE	ROUND	SQUARE	ROUND	SQUARE	ROUND	SQUARE	
Roman Ionic	Height	N/A	3 ³ / ₁₆ "	4 ¹ / ₈ "	4 ¹ / ₈ "	4 ⁷ / ₈ "	4 ³ / ₈ "	6 ¹ / ₄ "	5 ⁵ / ₈ "	6 ³ / ₄ "	8 ⁷ / ₈ "	9 1/2"	9 1/2"	9 ⁹ / ₁₆ "	9 ⁹ / ₁₆ "	9 ⁹ / ₁₆ "	9 ⁹ / ₁₆ "	9 ⁹ / ₁₆ "	9 ⁹ / ₁₆ "	9 ⁹ / ₁₆ "	9 ⁹ / ₁₆ "	N/A	N/A	N/A	N/A
	Abacus	N/A	10 ¹ / ₈ "	8 ¹ / ₈ "	11 ¹ / ₁₆ "	10 ³ / ₄ "	14 ³ / ₄ "	12 ¹ / ₂ "	16 ⁷ / ₈ "	17 ¹ / ₈ "	19 ³ / ₁₆ "	26"	25 ¹ / ₄ "	25 ¹ / ₄ "	25 ¹ / ₁₆ "	26 ³ / ₈ "	26 ³ / ₈ "	26 ³ / ₈ "	26 ³ / ₈ "	26 ³ / ₈ "	26 ³ / ₈ "	N/A	N/A	N/A	N/A
	Projection	N/A	3 ¹ / ₄ "	3 ¹ / ₈ "	3"	4 ¹ / ₈ "	4 ¹ / ₈ "	5"	6 ¹ / ₄ "	7 ⁷ / ₈ "	8"	8 ¹ / ₂ "	11 ¹ / ₄ "	11 ¹ / ₄ "	10"	9 ⁷ / ₈ "	9 ⁷ / ₈ "	9 ⁷ / ₈ "	9 ⁷ / ₈ "	9 ⁷ / ₈ "	9 ⁷ / ₈ "	N/A	N/A	N/A	N/A
	O/S to O/S	N/A	12 ¹ / ₈ "	10 ¹ / ₂ "	13 ³ / ₁₆ "	13 ³ / ₁₆ "	17 ¹ / ₄ "	16 ¹ / ₂ "	23 ³ / ₈ "	22 ⁷ / ₁₆ "	24 ³ / ₈ "	32 ¹ / ₈ "	31 ³ / ₄ "	31 ³ / ₄ "	33"	34"	34"	34"	34"	34"	34"	N/A	N/A	N/A	N/A
	Inside Dia.*	N/A	2 ¹ / ₈ "	2 ¹ / ₈ "	4 ¹ / ₂ "	4 ¹ / ₂ "	5"	5"	11 ¹ / ₂ "	11 ¹ / ₂ "	13 ¹ / ₈ "	15 ³ / ₈ "	17 ³ / ₈ "	17 ³ / ₈ "	19 ³ / ₈ "	19 ³ / ₈ "	19 ³ / ₈ "	19 ³ / ₈ "	19 ³ / ₈ "	19 ³ / ₈ "	19 ³ / ₈ "	N/A	N/A	N/A	N/A
Greek Ionic	Height	N/A	5 ¹ / ₂ "	4 ¹ / ₈ "	6 ¹ / ₄ "	5 ⁵ / ₈ "	6 ³ / ₄ "	9 ¹ / ₄ "	7"	10 ¹ / ₈ "	11 ¹ / ₈ "	11"	10 5/8"	11 ³ / ₈ "	13 ⁷ / ₈ "	13 ⁷ / ₈ "	13 ⁷ / ₈ "	13 ⁷ / ₈ "	13 ⁷ / ₈ "	13 ⁷ / ₈ "	13 ⁷ / ₈ "	N/A	N/A	19 ¹ / ₄ "	
	Abacus	N/A	11"	7 ⁵ / ₁₆ "	12 ³ / ₈ "	10 ¹¹ / ₁₆ "	16"	14 ³ / ₈ "	17 ³ / ₄ "	15 ⁵ / ₈ "	22 ³ / ₈ "	26 ³ / ₁₆ "	22 ³ / ₁₆ "	25 ¹ / ₄ "	29"	29"	29"	29"	29"	29"	N/A	N/A	N/A	42 ¹ / ₂ "	
	Projection	N/A	4 ⁷ / ₈ "	3 ⁵ / ₈ "	4 ⁷ / ₈ "	5"	5 ⁷ / ₈ "	7 ¹ / ₂ "	7 ¹ / ₄ "	6 ¹ / ₂ "	10 ³ / ₄ "	10 ³ / ₄ "	9 1/2"	11 ¹ / ₄ "	15 ¹ / ₂ "	15 ¹ / ₂ "	15 ¹ / ₂ "	15 ¹ / ₂ "	15 ¹ / ₂ "	15 ¹ / ₂ "	15 ¹ / ₂ "	N/A	N/A	19 ¹ / ₂ "	
	O/S to O/S	N/A	14 ¹ / ₂ "	11 ¹ / ₈ "	17 ⁹ / ₁₆ "	14 ⁵ / ₁₆ "	20 ⁷ / ₈ "	20 ¹ / ₁₆ "	26 ³ / ₈ "	20 ¹¹ / ₁₆ "	29 ¹ / ₄ "	36 ³ / ₁₆ "	29 ¹ / ₈ "	31 ³ / ₄ "	43 ¹ / ₂ "	43 ¹ / ₂ "	43 ¹ / ₂ "	43 ¹ / ₂ "	43 ¹ / ₂ "	43 ¹ / ₂ "	43 ¹ / ₂ "	N/A	N/A	60 ³ / ₄ "	
	Inside Dia.*	N/A	2 ¹ / ₈ "	2 ¹ / ₈ "	4 ¹ / ₂ "	4 ¹ / ₂ "	5"	5"	11 ¹ / ₂ "	11 ¹ / ₂ "	13 ¹ / ₈ "	15 ³ / ₈ "	15 ³ / ₈ "	17 ³ / ₈ "	19 ³ / ₈ "	19 ³ / ₈ "	19 ³ / ₈ "	19 ³ / ₈ "	19 ³ / ₈ "	19 ³ / ₈ "	19 ³ / ₈ "	N/A	N/A	26 ¹ / ₂ "	
Temple of the Winds	Height	N/A	8 ⁷ / ₁₆ "	8"	11 ¹ / ₂ "	10 ¹ / ₁₆ "	13 ⁷ / ₈ "	11 ³ / ₈ "	20 ¹ / ₂ "	16 ¹ / ₄ "	18 ¹ / ₄ "	21 ⁵ / ₁₆ "	21 ⁷ / ₈ "	23"	24 ¹ / ₈ "	27 ¹ / ₈ "	27 ¹ / ₈ "	27 ¹ / ₈ "	27 ¹ / ₈ "	27 ¹ / ₈ "	N/A	N/A	N/A	N/A	
	Abacus	N/A	12 ¹ / ₈ "	11 ¹ / ₈ "	15 ¹ / ₂ "	13 ⁷ / ₁₆ "	21 ³ / ₁₆ "	16 ³ / ₁₆ "	25 ³ / ₁₆ "	23 ³ / ₁₆ "	29 ¹ / ₄ "	36 ³ / ₁₆ "	29 ¹ / ₈ "	31 ³ / ₄ "	43 ¹ / ₂ "	43 ¹ / ₂ "	43 ¹ / ₂ "	43 ¹ / ₂ "	43 ¹ / ₂ "	43 ¹ / ₂ "	N/A	N/A	N/A	N/A	
	Projection	N/A	4 ⁷ / ₈ "	5 ¹ / ₂ "	5 ¹ / ₈ "	6"	8"	7"	9 ⁷ / ₈ "	10 ⁷ / ₈ "	11 ¹ / ₈ "	9 ¹ / ₄ "	12"	15 ¹ / ₂ "	14 ⁷ / ₈ "	16 ¹ / ₈ "	16 ¹ / ₈ "	16 ¹ / ₈ "	16 ¹ / ₈ "	16 ¹ / ₈ "	16 ¹ / ₈ "	N/A	N/A	N/A	N/A
	O/S to O/S	N/A	12 ¹ / ₈ "	11 ¹ / ₈ "	15 ¹ / ₂ "	13 ⁷ / ₁₆ "	21 ³ / ₁₆ "	16 ³ / ₁₆ "	25 ³ / ₁₆ "	23 ³ / ₁₆ "	29 ¹ / ₄ "	36 ³ / ₁₆ "	29 ¹ / ₈ "	31 ³ / ₄ "	43 ¹ / ₂ "	43 ¹ / ₂ "	43 ¹ / ₂ "	43 ¹ / ₂ "	43 ¹ / ₂ "	43 ¹ / ₂ "	43 ¹ / ₂ "	N/A	N/A	N/A	N/A
	Inside Dia.*	N/A	2 ¹ / ₈ "	2 ¹ / ₈ "	4 ¹ / ₂ "	4 ¹ / ₂ "	5"	5"	11 ¹ / ₂ "	11 ¹ / ₂ "	13 ¹ / ₈ "	15 ³ / ₈ "	15 ³ / ₈ "	17 ³ / ₈ "	19 ³ / ₈ "	19 ³ / ₈ "	19 ³ / ₈ "	19 ³ / ₈ "	19 ³ / ₈ "	19 ³ / ₈ "	19 ³ / ₈ "	N/A	N/A	N/A	N/A
Roman Corinthian	Height	N/A	10 ³ / ₄ "	8 ¹¹ / ₁₆ "	13 ¹ / ₁₆ "	11 ⁵ / ₁₆ "	17 ³ / ₄ "	14 ³ / ₈ "	20 ¹ / ₈ "	17 ³ / ₈ "	22 ¹ / ₁₆ "	26 ¹ / ₂ "	26 ¹ / ₁₆ "	28 ⁷ / ₁₆ "	31 ⁷ / ₈ "	34 ¹ / ₄ "	34 ¹ / ₄ "	34 ¹ / ₄ "	34 ¹ / ₄ "	34 ¹ / ₄ "	34 ¹ / ₄ "	N/A	N/A	N/A	N/A
	Abacus	N/A	13 ¹ / ₄ "	12 ¹ / ₁₆ "	18"	14 ⁷ / ₈ "	22 ³ / ₈ "	18 ¹ / ₈ "	26 ¹ / ₄ "	22 ³ / ₁₆ "	32 ³ / ₈ "	37 ¹ / ₂ "	38 ⁷ / ₈ "	41 ³ / ₈ "	40 ¹ / ₄ "	45 ¹ / ₄ "	45 ¹ / ₄ "	45 ¹ / ₄ "	45 ¹ / ₄ "	45 ¹ / ₄ "	N/A	N/A	N/A	N/A	
	Projection	N/A	4 ¹ / ₄ "	4 ¹ / ₄ "	6"	6 ¹ / ₄ "	7 ⁷ / ₈ "	8 ¹ / ₄ "	8 ¹ / ₈ "	8 ¹ / ₈ "	14 ¹ / ₄ "	13 ³ / ₈ "	17 ¹ / ₂ "	17 ¹ / ₂ "	16 ¹ / ₄ "	16 ¹ / ₄ "	16 ¹ / ₄ "	16 ¹ / ₄ "	16 ¹ / ₄ "	16 ¹ / ₄ "	N/A	N/A	N/A	N/A	
	O/S to O/S	N/A	13 ¹ / ₄ "	12 ¹ / ₁₆ "	18"	14 ⁷ / ₈ "	22 ³ / ₈ "	18 ⁷ / ₈ "	26 ¹ / ₄ "	22 ³ / ₁₆ "	32 ³ / ₈ "	37 ¹ / ₂ "	38 ⁷ / ₈ "	41 ³ / ₈ "	40 ¹ / ₄ "	45 ¹ / ₄ "	45 ¹ / ₄ "	45 ¹ / ₄ "	45 ¹ / ₄ "	45 ¹ / ₄ "	45 ¹ / ₄ "	N/A	N/A	N/A	N/A
	Inside Dia.*	N/A	2 ¹ / ₈ "	2 ¹ / ₈ "	4 ¹ / ₂ "	4 ¹ / ₂ "	5"	5"	11 ¹ / ₂ "	11 ¹ / ₂ "	13 ¹ / ₈ "	15 ³ / ₈ "	15 ³ / ₈ "	17 ³ / ₈ "	19 ³ / ₈ "	19 ³ / ₈ "	19 ³ / ₈ "	19 ³ / ₈ "	19 ³ / ₈ "	19 ³ / ₈ "	19 ³ / ₈ "	N/A	N/A	N/A	N/A
Scaezzi	Height	N/A	3 ¹ / ₄ "	3 ³ / ₈ "	5"	4 ¹ / ₈ "	5 ⁵ / ₁₆ "	5 ¹ / ₁₆ "	6 ¹ / ₂ "	5 ³ / ₄ "	7 ¹ / ₁₆ "	8 ³ / ₁₆ "	8 ³ / ₁₆ "	8 ³ / ₁₆ "	10 ¹ / ₄ "	11 ¹ / ₂ "	12 ¹ / ₄ "	12 ¹ / ₄ "	12 ¹ / ₄ "	12 ¹ / ₄ "	12 ¹ / ₄ "	12 ¹ / ₄ "	12 ¹ / ₄ "	15 ¹ / ₄ "	
	Abacus	N/A	11 ¹ / ₄ "	9 ⁷ / ₈ "	16 ³ / ₁₆ "	14 ¹ / ₄ "	17 ³ / ₈ "	16 ³ / ₈ "	20 ⁷ / ₈ "	18 ¹ / ₄ "	23 ¹ / ₄ "	26"	28 ⁵ / ₈ "	28 ¹ / ₂ "	32"	36"	38 ¹ / ₄ "	38 ¹ / ₄ "	38 ¹ / ₄ "	38 ¹ / ₄ "	38 ¹ / ₄ "	38 ¹ / ₄ "	46 ¹ / ₄ "		
	Projection	N/A	3 ³ / ₈ "	3 ³ / ₈ "	5 ¹ / ₈ "	5 ¹ / ₈ "	5 ¹ / ₈ "	6"	6"	6 ³ / ₈ "	8 ³ / ₄ "	5 ¹ / ₄ "	10 ¹ / ₄ "	10 ¹ / ₄ "	10 ¹ / ₄ "	12 ¹ / ₂ "	13 ¹ / ₄ "	13 ¹ / ₄ "	13 ¹ / ₄ "	13 ¹ / ₄ "	13 ¹ / ₄ "	13 ¹ / ₄ "	16 ¹ / ₈ "		
	O/S to O/S	N/A	11 ³ / ₈ "	10"	16 ³ / ₁₆ "	14 ¹ / ₄ "	18 ¹ / ₁₆ "	16 ³ / ₈ "	20 ⁷ / ₈ "	18 ¹ / ₈ "	23 ¹ / ₄ "	26"	28 ⁵ / ₈ "	28 ¹ / ₂ "	32"	36"	38 ¹ / ₄ "	38 ¹ / ₄ "	38 ¹ / ₄ "	38 ¹ / ₄ "	38 ¹ / ₄ "	38 ¹ / ₄ "	46 ¹ / ₄ "		
	Inside Dia																								

PermaWrap® Columns NON-STOCK
SPECIAL ORDER ITEM

PERMAWrap®
C O L U M N S

- 25 year limited warranty
- Custom styles available
- Made from cellular PVC
- Installation kit included
- Interior and exterior use
- Weather proof
- Insect proof
- Low maintenance



12" PermaWrap® Column with
Tuscan Base and Custom Cap

Custom PermaWrap® Columns

From 5" to 24" wide and 2' to 20' in length, you can now order the perfect custom column for your home or neighborhood project. Custom columns are manufactured using 3/8", 1/2", or 5/8" cellular PVC. Ask HB&G today how you can put a unique signature on your next custom project. Simply visit our website, www.hbgcolumns.com, or contact our Architectural Department at 1-800-264-4HBG (4424).

Two Ways to Order PermaWrap® Columns



Assembled

L-Assembly

- Assembled**
- Manufactured from cellular PVC
 - Fully Assembled (with or without post)
 - Ready to Install
- L-Assembly**
- Manufactured from 3/8", 1/2", or 5/8" cellular PVC
 - Shipped in two L-shaped halves
 - Square Column Ready to Wrap Around an Existing Post
 - Available in Plain, Fluted, Raised Panel, or Recessed Panel
 - Craftsman Columns Available in Plain, Raised, and Recessed Panel Styles

(items are approximate scale only)

NON-STOCK
SPECIAL ORDER ITEM

PermaWrap® Columns

Leading the industry in column innovation, HB&G PermaWrap® columns are made from cellular PVC and offer the advantages of being unaffected by moisture and insects but with the thickness, ease of use, and workability of wood.

PermaWrap® columns are available in all sizes and styles – square or craftsman – plain, fluted, raised panel, and recessed panel. With all of these options, you are certain to find just the right amount of detail for your specific project.

Best of all, the PermaWrap® column comes with a 25-year HB&G warranty.



24" x 18' Square Recessed PermaWrap® Columns



10" x 8' Custom Raised Panel Square PermaWrap® Columns and Custom Rail Design



14" x 10' Custom Raised Panel PermaWrap® Columns



16" x 6' Craftsman PermaWrap® Column with Pedestal

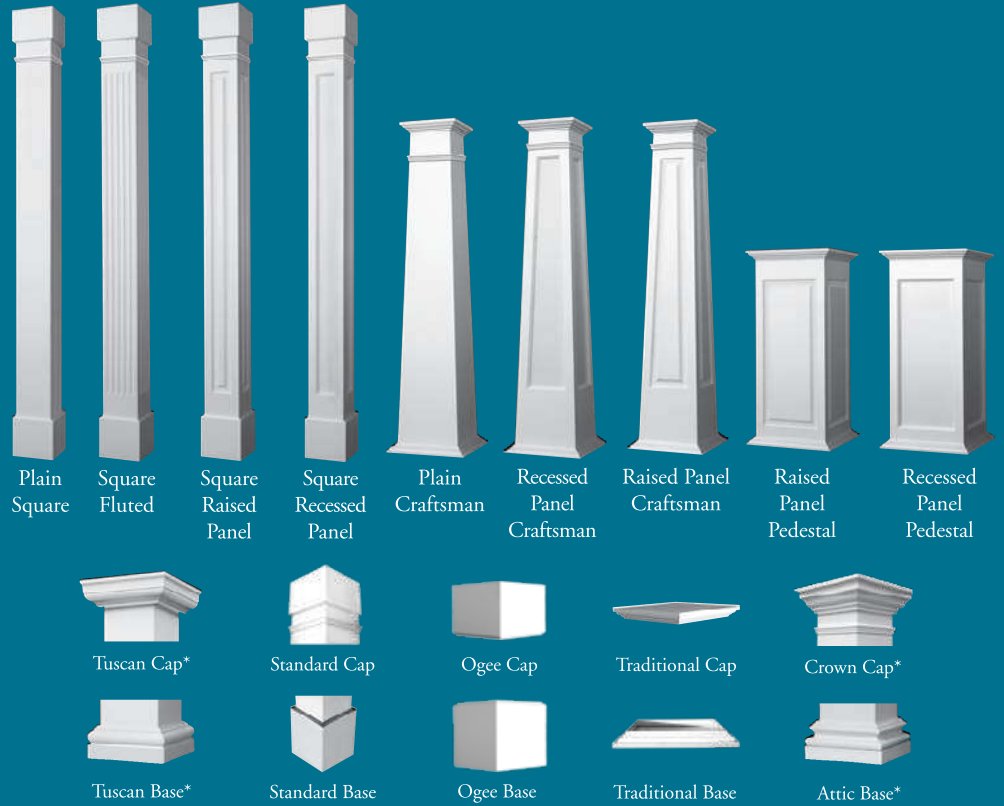

*Made from polyurethane and may need to be split in the field for installation.

Examples of custom PermaWrap® columns

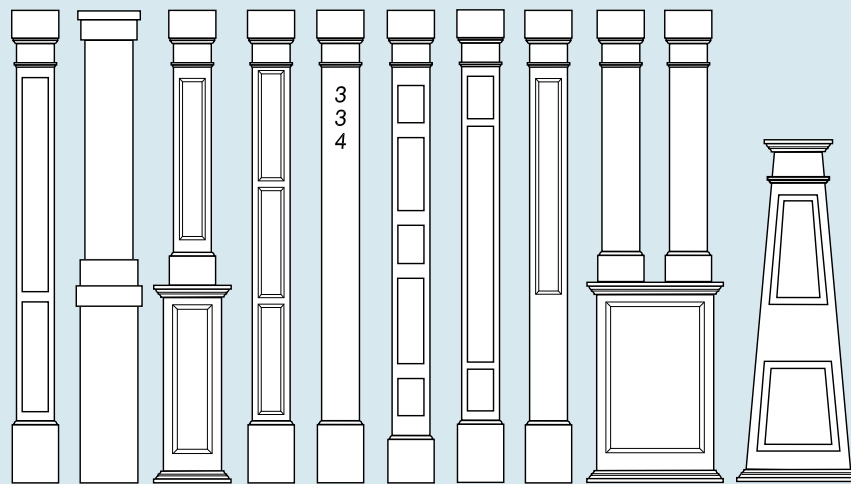

PLAIN PERMAWRAP® DIMENSIONS (IN INCHES)

	Col Width	A	C	G	L	R	U	Lengths
Assembled	6"	5 ⁷ / ₈ "	7 ¹ / ₈ "	1"	7 ¹ / ₈ "	9"	7"	8', 10'
	8"	7 ⁷ / ₈ "	9 ¹ / ₈ "	1"	9 ¹ / ₈ "	9"	7"	8', 10', 12'
	10"	9 ⁷ / ₈ "	11 ¹ / ₈ "	1"	11 ¹ / ₈ "	9"	7"	8', 10', 12'
	12"	11 ⁷ / ₈ "	13 ¹ / ₈ "	1"	13 ¹ / ₈ "	9"	7"	8', 10', 12'
L Assembly	6"	5 ⁷ / ₈ "	7 ¹ / ₈ "	1"	7 ¹ / ₈ "	9"	7"	8', 10'
	8"	7 ⁷ / ₈ "	9 ¹ / ₈ "	1"	9 ¹ / ₈ "	9"	7"	8', 10', 12'
	10"	9 ⁷ / ₈ "	11 ¹ / ₈ "	1"	11 ¹ / ₈ "	9"	7"	8', 10', 12'
	12"	11 ⁷ / ₈ "	13 ¹ / ₈ "	1"	13 ¹ / ₈ "	9"	7"	8', 10', 12'

Additional sizes are available from 5" to 24" wide and 2' to 20' in length.

INSIDE DIMENSIONS

6"	4 ³ / ₈ "
8"	6 ³ / ₈ "
10"	8 ³ / ₈ "
12"	10 ³ / ₈ "

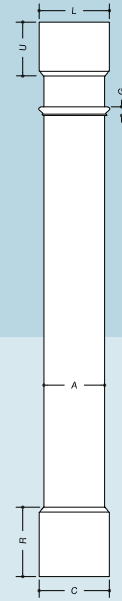
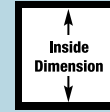

PERMAWRAP® FLUTED, RECESSED PANEL, AND RAISED PANEL DIMENSIONS (IN INCHES)

Col Width	A	C	G	L	N	O	S*	R	U	Lengths
6"	5 ⁷ / ₈ "	7 ¹ / ₈ "	1 ¹ / ₈ "	7 ¹ / ₈ "	6"	6"	1 ³ / ₄ "	9"	7"	6', 8', 9', 10', 12'
8"	7 ⁷ / ₈ "	9 ¹ / ₈ "	1 ¹ / ₈ "	9 ¹ / ₈ "	6"	6"	1 ³ / ₄ "	9"	7"	6', 8', 9', 10', 12'
10"	9 ⁷ / ₈ "	11 ¹ / ₈ "	1 ¹ / ₈ "	11 ¹ / ₈ "	6"	6"	1 ³ / ₄ "	9"	7"	6', 8', 9', 10', 12'
12"	11 ⁷ / ₈ "	13 ¹ / ₈ "	1 ¹ / ₈ "	13 ¹ / ₈ "	6"	6"	1 ³ / ₄ "	9"	7"	6', 8', 9', 10', 12'

Rail breaks are 7" long and designed to fit 36" or 42" rail heights.

*S dimension for 6" raised panel is 1-1/4", 8" raised panel is 1-1/2".

S dimension for fluted columns vary.

Additional sizes are available from 5" to 24" wide and 2' to 20' in length.

INSIDE DIMENSIONS

6"	3 ⁷ / ₈ "
8"	5 ⁷ / ₈ "
10"	7 ⁷ / ₈ "
12"	9 ⁷ / ₈ "

NUMBER OF FLUTES PER SIDE

6"	3
8"	5
10"	7
12"	8

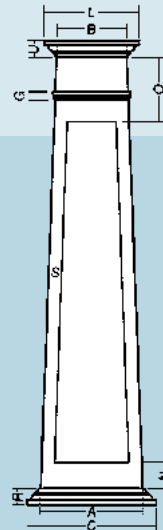
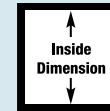

PERMAWRAP® CRAFTSMAN DIMENSIONS (IN INCHES)

Col Width	A	B	C	G	L	N	O	S	R	U	Lengths
12"X8"	11 ⁷ / ₈ "	7 ⁷ / ₈ "	14 ⁷ / ₈ "	1 ¹ / ₈ "	10 ⁷ / ₈ "	6"	6"	1 ³ / ₄ "	2"	2"	54", 60", 66", 72", 84", 96"
16"X10"	15 ⁷ / ₈ "	9 ⁷ / ₈ "	18 ⁷ / ₈ "	1 ¹ / ₈ "	12 ⁷ / ₈ "	6"	6"	1 ³ / ₄ "	2"	2"	54", 60", 66", 72", 96"
20"X15"	19 ⁷ / ₈ "	14 ⁷ / ₈ "	22 ⁷ / ₈ "	1 ¹ / ₈ "	17 ⁷ / ₈ "	6"	6"	1 ³ / ₄ "	2"	2"	54", 60", 66", 72", 96"

Additional sizes are available from 5" to 24" wide and 2' to 20' in length.

INSIDE DIMENSIONS

	Bottom	Top
12" x 8"	10 ³ / ₈ "	5 ⁷ / ₈ "
16" x 10"	14 ³ / ₈ "	6 ⁷ / ₈ "
20" x 15"	18 ³ / ₈ "	12 ⁷ / ₈ "

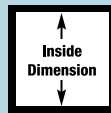

PERMAWRAP® PEDESTAL DIMENSIONS (IN INCHES)

Col Width	A	C	L	N	O	S	R	U	Lengths
16"	15 ⁷ / ₈ "	18 ⁷ / ₈ "	18 ⁷ / ₈ "	6"	6"	1 ³ / ₄ "	2"	2"	40", 46"
20"	19 ⁷ / ₈ "	22 ⁷ / ₈ "	22 ⁷ / ₈ "	6"	6"	1 ³ / ₄ "	2"	2"	40", 46"
24"	23 ⁷ / ₈ "	26 ⁷ / ₈ "	26 ⁷ / ₈ "	6"	6"	1 ³ / ₄ "	2"	2"	40", 46"

Additional sizes are available from 5" to 24" wide and 2' to 20' in length.

INSIDE DIMENSIONS

16"	13 ⁷ / ₈ "
20"	15 ⁷ / ₈ "
24"	21 ⁷ / ₈ "

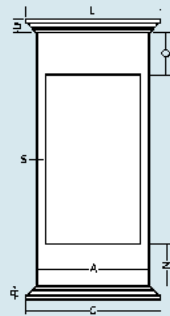
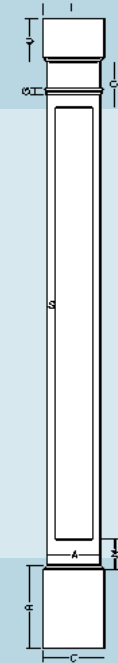
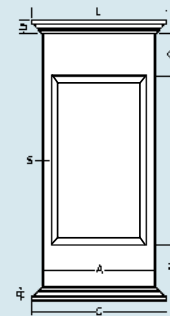
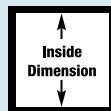

PVC Painting and Finishing

Caulk where required using Siroflex brand Sealant and Adhesive provided by manufacturer. Putty any holes using acrylic putty or caulk. Lightly sand or scuff surface of column. Clean surface of column to remove any dirt or hand oil residue with light detergent and water, denatured alcohol, or window cleaner. Be sure to remove soap residue with clean water. Apply one coat of 100% acrylic exterior primer and one or more finish coats of 100% acrylic exterior paint.

Do not paint columns using dark colors (dark colors are considered any color that falls within the L value of 56 to 0). L is a measure of lightness of an object and ranges from 0 (black) to 100 (white).

PermaLite® Columns

- Weather Proof
- Insect Proof
- Load Bearing
- Low Maintenance
- Lightweight
- Ready to Prime and Paint
- Limited Lifetime Warranty



PermaLite™ Square Columns

(items are approximate scale only)

HB&G PermaLite® columns are cost effective, load bearing, versatile, and require very little maintenance. The PermaLite® columns are available in round and square. PermaLite® columns deliver all of the beauty at 1/3 of the weight.



PermaLite®
Round
No-Taper

PermaLite®
Square Plain

PermaLite®
Square Recessed
(with panel kit)

PermaLite® Square
Recessed (with panel
divider kit)

PermaLite® Square
Recessed (with 2-panel
divider kits)

TOP VIEW CUT-AWAY

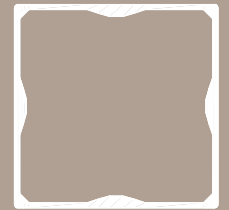

PermaLite® Plain

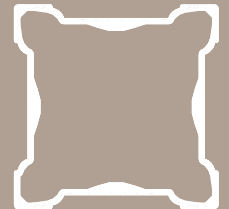

PermaLite® Recessed



PermaLite® Round



Square Tuscan Cap



Round Tuscan Cap



Square Tuscan Base



Round Tuscan Base

For
Tuscan
Cap and Base
Dimensions
please see p.27

(items are approximate scale only)

PermaLite™ Square Columns

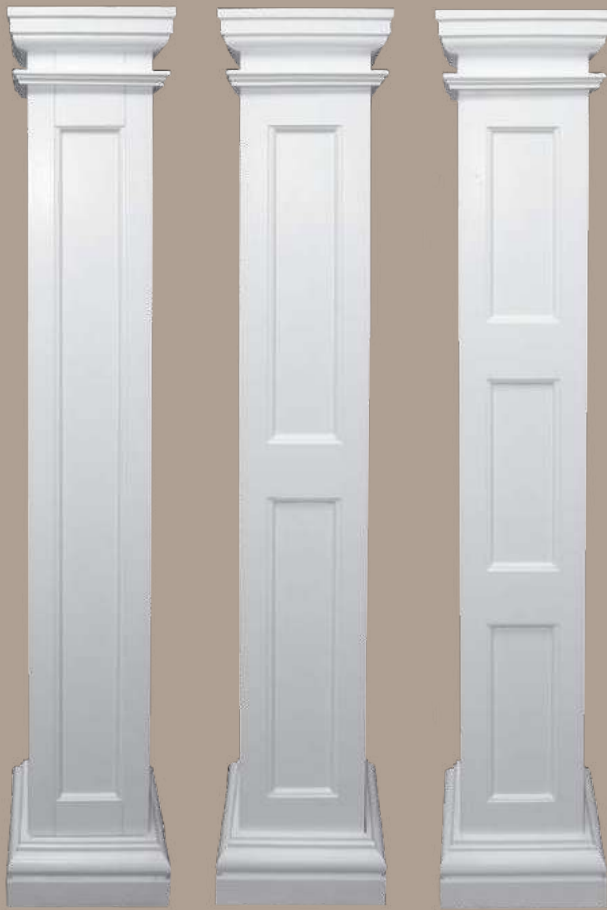

PERMALITE® PANEL DIVIDER KITS TO CONVERT A SINGLE PANEL COLUMN INTO A 2 OR 3-PANEL COLUMN

RECESSED – Includes four top panel insert pieces and four bottom panel insert pieces. **PANEL DIVIDER KITS** are available.

Kit Size	Width	Height
8" Panel Divider Kit (4 Pieces)	4 ⁷ / ₈ "	2 ¹ / ₄ "
10" Panel Divider Kit (4 Pieces)	5 ⁵ / ₁₆ "	5 ¹ / ₈ "

1 panel kit to achieve 2-panel column.
2 panel kits to achieve 3-panel column.

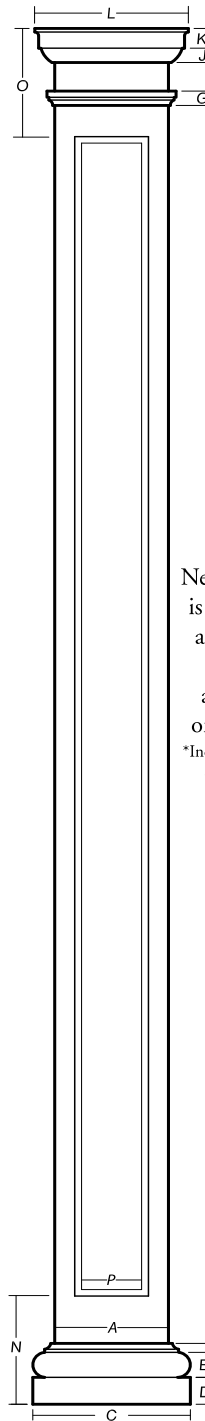

PermaLite® Square Column shown with Tuscan Cap and Base

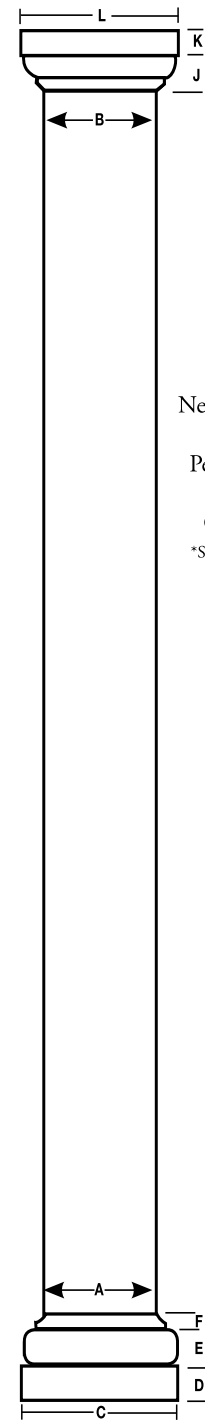

PermaLite® Round No-Taper Column shown with Tuscan Cap and Base

Neck Mould* is adjustable and can be applied anywhere on column.
*Included with cap and base set.

Neck Mould* for PermaLite® Round Column
*Sold separately



PermaLite™ Square Columns

(items are approximate scale only)

PLAIN AND RECESSED PANEL SQUARE PERMALITE® COLUMN DIMENSIONS (IN INCHES)

Col. Size	A	C	D	E	F	G	J	K	L	N	O	P	Lengths Avail. (ft.)
6"	5-1/2"	8-1/2"	1-1/2"	1-1/4"	1/2"	1"	7/8"	1-1/16"	8"	N/A	N/A	N/A	6, 8, 9, 10
8"	7-1/2"	11"	1-15/16"	1-11/16"	3/4"	1"	1"	1-7/16"	10-1/16"	8"	8"	3-7/8"	6, 8, 9, 10, 12
8"*	7-1/2"	10-7/16"	1-7/8"	1-11/16"	5/8"	1"	1"	1-3/8"	10-1/4"	8"	8"	3-7/8"	6, 8, 9, 10, 12
10"	9-1/2"	12-15/16"	2-1/2"	2-1/8"	3/4"	1"	1-5/16"	1-3/4"	12-3/4"	9"	9"	4-3/8"	6, 8, 9, 10, 12
10"*	9-1/2"	13-1/8"	2-3/8"	2-1/8"	3/4"	1"	1-1/4"	1-3/4"	12-3/4"	9"	9"	4-3/8"	6, 8, 9, 10, 12
12"	11-1/2"	15-1/4"	2-3/4"	2-7/16"	13/16"	1"	1-3/8"	2"	15-7/8"	N/A	N/A	N/A	6, 8, 9, 10, 12

- * Sim caps and bases. The remainder are poly caps and bases.
- See drawing on page 30.

NOTES: Recessed Panel top inset – 8" = 8", 10" = 9"; Bottom inset – 8" = 8", 10" = 9". Neck mould is adjustable and is applied in the field. Recessed Panel available in 8" and 10" sizes only. Factory split PermaLite® columns are not available. HB&G does not recommend splitting PermaLite® columns.

SQUARE PERMALITE® INSIDE DIMENSION

Col. Width	Inside
6"	4-5/8"
8"	6-5/8"*
10"	8-5/8"*
12"	10-5/8"

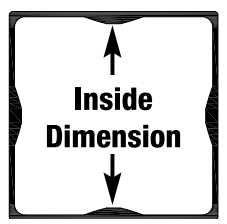

COLONIAL SQUARE CAP AND BASE FOR PERMALITE®

Col. Size	C	D	E	F	J	K	L	R
6"	8 1/8"	1 1/4"	1 1/16"	7/16"	5/8"	1"	7 7/16"	2 3/4"
8"	10 1/8"	1 1/4"	1 1/16"	7/16"	15/16"	1"	9 7/16"	2 3/4"
10"	12 1/8"	1 1/4"	1 1/16"	7/16"	15/16"	1 1/4"	12 1/8"	2 3/4"
12"	14 1/8"	1 1/4"	1 1/16"	7/16"	1"	1 3/8"	14 1/4"	2 3/4"

- Neck moulding is 4 pieces included with the cap and base.
- See drawings on page 30.

*Recessed Panel Inside Dimensions 8" - 5-5/8"; 10" - 7-5/8"

ROUND PERMALITE® NO-TAPER COLUMN DIMENSIONS

Col. Size	A	B	C	D	E	F	J	K	L	Lengths
8"	7-5/8"	7-5/8"	10-1/2"	1-7/8"	1-3/4"	3/4"	1-1/4"	1-1/2"	10-5/8"	6', 8', 9', 10'
10"	9-5/8"	9-5/8"	13-1/8"	2-3/8"	2-1/8"	3/4"	1-1/4"	1-3/4"	12-3/4"	6', 8', 9', 10', 12'

ROUND PERMALITE® DIMENSIONS

Inside diameter may vary up to 1/8".

COLUMN SIZE	ID
8"	7-3/8"
10"	9-3/8"

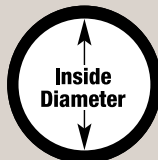

One Piece Neck Mould
for 8" and 10" Round
No-Taper Column
Is Available.

Neck Ring Sold Separately.



(items are approximate scale only)

NON-STOCK
SPECIAL ORDER ITEM

PermaSnap™ Column Wrap

PermaSnap™ Column Wrap

- 25 Year Limited Warranty
- Low Maintenance
- Weather Proof
- Made from cPVC
- Insect Proof
- Easy Installation

Transform a treated post into a finished column in minutes with PermaSnap™. PermaSnap™ column wrap's patented snap design permits easy installation by one person. It can also be used as a newel post wrap.

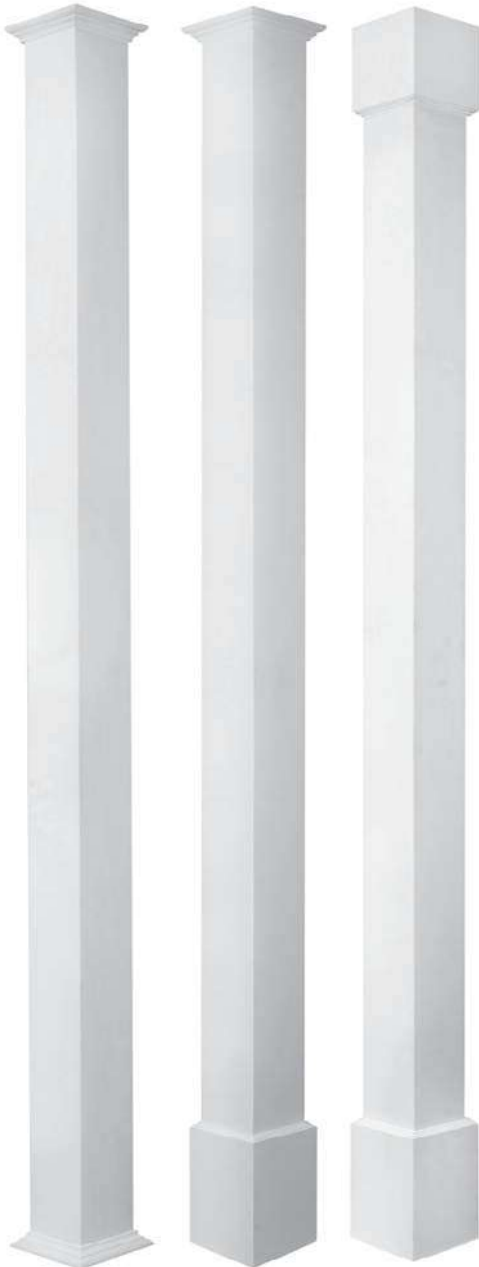

Bed Mould*

Hampton

Chesapeake

PermaSnap™ Column Wrap Technical Specifications

Product Description	Actual Inside Dimension	Actual Outside Dimension	Column Wrap Will Fit
4" x 4" x 8'-6"	4" x 4" x 8'-6"	4-3/4" x 4-3/4" x 8'-6"	4" x 4" Post
4" x 4" x 10'-0"	4" x 4" x 10'-0"	4-3/4" x 4-3/4" x 10'-0"	4" x 4" Post
6" x 6" x 8'-6"	6" x 6" x 8'-6"	6-3/4" x 6-3/4" x 8'-6"	6" x 6" Post
6" x 6" x 10'-0"	6" x 6" x 10'-0"	6-3/4" x 6-3/4" x 10'-0"	6" x 6" Post
8" x 8" x 8'-6"	8-3/4" x 8-3/4" x 8'-6"	9-1/2" x 9-1/2" x 8'-6"	8" x 8" Post
8" x 8" x 10'-0"	8-3/4" x 8-3/4" x 10'-0"	9-1/2" x 9-1/2" x 10'-0"	8" x 8" Post
10" x 10" x 8'-6"	10-3/4" x 10-3/4" x 8'-6"	11-1/2" x 11-1/2" x 8'-6"	10" x 10" Post
10" x 10" x 10'-0"	10-3/4" x 10-3/4" x 10'-0"	11-1/2" x 11-1/2" x 10'-0"	10" x 10" Post

*There may be a variance of up to 1/8" in all dimensions.

PermaSnap™ Accessories

Accessories	Sizes Available
Bed Mould Trim Kit*	4, 6, 8, and 10"
Hampton Trim Kit	4, 6, 8, and 10"
Chesapeake Trim Kit	4, 6, 8, and 10"
Bed Mould XL	4, 6, 8, and 10"
Neck Mould	4, 6, 8, and 10"
Charleston Newel Cap	4"
Wilmington Newel Cap	4"
Ashbury Newel Cap	6"

*Bed Mould Trim Kit is needed for both ends
NOTE: Accessories sold separately.



Charleston 4" Newel Cap



Wilmington 4" Newel Cap



Ashbury 6" Newel Cap





ARCHITECTURAL COLUMNS

We offer columns ranging from the timeless architectural orders to more modern no-taper rounds, squares (plain and panel), craftsman, colonial, and barrel columns. Columns are available in paint grade woods (finger-jointed pine, redwood, or cedar) for interior or exterior use or stain grade woods for interior applications (most common stain grade species are shown below). We recommend using western red cedar or heart redwood for exterior applications due to their superior natural weather-resistant characteristics. We can factory prime columns to be painted and apply coating for added protection for columns to be installed outside.

SHAFT SPECIFICATIONS FOR TUSCAN, ROMAN IONIC, ROMAN DORIC, AND ROMAN CORINTHIAN COLUMNS				
Shaft Nominal Diameter	Bottom	Top	Flutes	
	Net Inside Diameter	Net Inside Diameter	Number	Width
6"	3"	2 1/2"	24	1/2"
8"	5 1/4"	4 3/8"	24	1 1/16"
10"	7 1/4"	6 3/8"	24	7/8"
12"	9"	7 3/4"	24	1"
14"	10 1/8"	9"	24	1 1/4"
16"	12"	10"	24	1 1/4"
18"	14 1/4"	12"	24	1 1/2"
20"	16 1/4"	13"	24	1 11/16"
22"	18 1/4"	15"	24	1 5/16"
24"	20 1/4"	17"	24	2 1/8"
26"	22 1/8"	19"	24	2 1/4"
28"	24 1/8"	21"	24	2 11/16"

THE CLASSIC COLUMNS

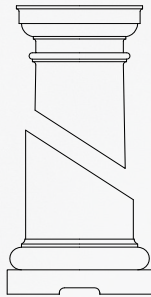

Tuscan

- Simplest and strongest design
- Usually Plain rather than fluted
- Shaft length, including cap and base, is seven times diameter.

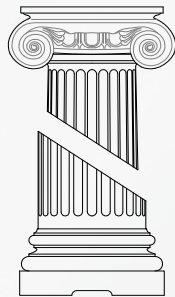

Roman Ionic

- Ornate design with decorative scrolled capital and Attic Base
- Contains 24 semi-circular flutes separated by fillets
- Shaft length, including cap and base, is nine times diameter.

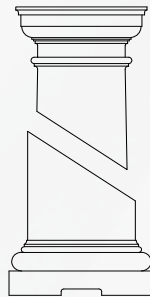

Roman Doric

- Next in strength and simplicity to the Tuscan cap and base contain additional moulding detail
- Usually Plain rather than fluted
- Shaft length, including cap and base, is eight times diameter.

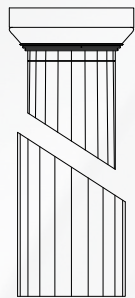

Greek Doric

- Has no base
- Contains 20 shallow flutes that form peaks (no fillets)
- Shaft length, including cap, is five and a half times diameter.

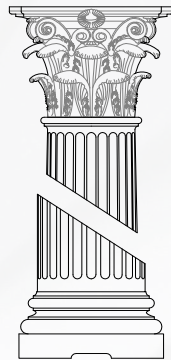

Roman Corinthian

- Most elegant style, features an inverted bell capital adorned with acanthus leaves and an Attic Base
- Fluted in the Ionic Style
- Shaft length, including cap and base, is ten times diameter.

MOST POPULAR STAIN GRADE WOOD SPECIES



Redwood



Ponderosa Pine



Mahogany



Cherry



Maple



Poplar



Walnut



Oak

FLUTE OPTIONS

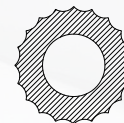

Greek Doric

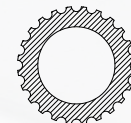

Roman Ionic

CUSTOM SPLITTING OPTIONS



Q



C



D



H



K



ROUND WOOD COLUMNS

COLUMN DIMENSIONS (IN INCHES)

COL. SIZE	A	B	C	D	E	F	G	J	K	L	O	N	R	T	LENGTHS AVAIL (ft)
6"	5 5/8"	4 3/8"	7 1/4"	1 3/8"	1 1/4"	3/16"	1 5/16"	1 1/8"	1 1/16"	7"	4 1/2"	8"	3 7/16"	2"	8,10
8"	7"	6 1/4"	9 1/4"	1 1/2"	1 1/4"	3/4"	1 5/16"	1 1/4"	1 1/4"	8 3/8"	4 1/2"	8"	3 3/4"	2"	8,10,12
10"	9"	8 1/4"	11 1/4"	1 1/2"	1 1/4"	3/4"	1 5/16"	1 1/4"	1 1/16"	10 1/2"	4 1/2"	8"	3 3/4"	2"	8,10,12
12"	11 1/8"	9 3/8"	13 3/8"	1 3/8"	1 1/4"	7/8"	1 5/16"	1 1/4"	1 3/8"	12"	4 1/2"	8"	3 3/8"	2"	8, 10, 12

Larger sizes available. Call for quote.

ROUND WOOD INSIDE DIMENSIONS

Inside diameter may vary up to 1/4".
Splitting a column will decrease inside dimension 1/8".

COL. DIA.	TOP I.D.	BOT I.D.
6"	3 1/8"	3 1/8"
8"	4 3/8"	4 3/8"
10"	6 3/4"	6 3/4"
12"	7 1/8"	9 3/8"

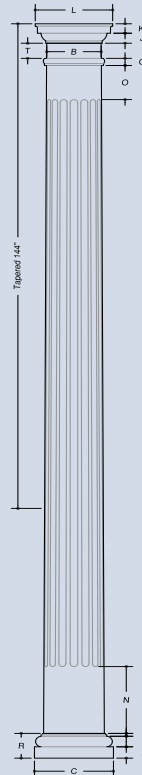
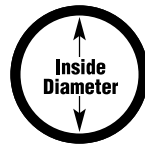

CAPITALS AND BASES FOR WOOD COLUMNS

CAPITAL DIMENSIONS FOR ROUND COLUMNS (IN INCHES)

Size of Columns (Diameter at bottom of shaft)		8"	10"	12"
Roman Ionic	Height	3 15/16"	4"	4 5/8"
	Abacus	8 1/8"	10 3/4"	12 1/2"
	Projection	3 1/8"	4 1/8"	5"
	O/S to O/S	10 1/2"	13 3/16"	16 1/2"
Greek Ionic	Height	4 1/8"	5 5/8"	6 9/16"
	Abacus	7 15/16"	10 11/16"	14 3/8"
	Projection	3 5/8"	5"	7 1/2"
	O/S to O/S	11 7/8"	14 15/16"	20 11/16"
Temple of the Winds	Height	8"	10 5/16"	11 5/8"
	Abacus	11 7/8"	13 7/16"	16 9/16"
	Projection	5 1/2"	6"	7"
	O/S to O/S	11 7/8"	13 7/16"	16 9/16"
Roman Corinthian	Height	8 11/16"	11 15/16"	14 5/8"
	Abacus	12 1/16"	14 3/8"	18 7/8"
	Projection	4 1/4"	6 1/4"	8 1/4"
	O/S to O/S	12 1/16"	14 3/8"	18 7/8"
Samozi	Height	3 1/8"	4 1/8"	5 1/16"
	Abacus	9 7/8"	14 1/4"	16 3/8"
	Projection	3 3/8"	5 3/8"	6"
	O/S to O/S	10"	14 1/4"	16 5/8"

8" - 12" LOAD BEARING ORNAMENTAL CAPITALS FOR ROUND WOOD COLUMNS

Adding a load bearing ornamental capital to a round wood column will lengthen or shorten the overall height of the column depending on the height of the capital. Subtract the "T" dimension (from the column dimensions chart) and add the height of the ornamental capital +/- 1/4" for overall column height.

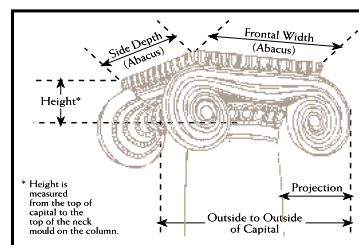
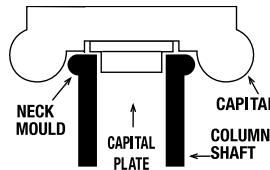

• 8"-12" Round Ornamental Capitals are load bearing.



Capitals and bases for wood columns are load bearing. The shaft fits between the capital and base and alters the height of the shaft. Several options are offered for wood columns.

CLASSIC CAPITAL AND BASE

The Classic style is standard and best complements the wood column.

ORNAMENTAL CAPITALS

Five styles of ornamental capitals are available. Nothing makes a statement like wood columns with an ornamental cap. 8"-12" ornamental capitals for Round wood columns are load bearing.

Using an ornamental capital with a wood shaft will alter the height of the shaft.

ATTIC BASE

Attic bases are used for a more ornate look and comes in two pieces. (In the chart, see DD for the plinth dimension and EE for the torus dimension.)

TIPS

When ordering an ornamental cap order the appropriate base for the column.

Ornamental caps will lengthen or shorten the height of the column.

Ensure exact opening measurement prior to ordering column length.

WHAT YOU NEED TO KNOW

- The height of a column includes capital and base (Ex. 8' = shaft 7' 6 1/2" and capital and base total 8').
- Cap and base fit on top and bottom of column insulating the column from the elements.
- Split columns are not load bearing.
- For transportation purposes, small sections of split columns are left partially intact.
- Store columns in dry, well-ventilated area.
- For exterior applications: Paint inside of column shaft with a nonfibrous asphaltum type roof coating. Application must reach minimum 48" up the inside bottom of the column shaft.
- Wood columns require ventilation at the top and bottom.
- Failure to adhere to installation instructions voids the warranty.

CAPITAL AND BASE OPTIONS

The same cap and base profiles offered in PermaCast® are also available for wood.

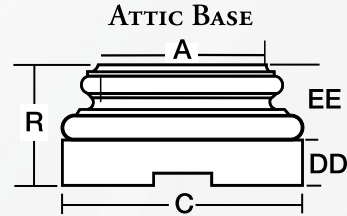

For columns 8" to 12" in diameter, bases, including plinth, are Polyurethane.

COLUMN SIZE	BOTTOM DIA. (NET)	ROUND BASE			
		A	C	DD	EE
6"*	CALL	CALL	CALL	CALL	CALL
8"	8 1/8"	10 1/4"	1 7/8"	3 1/4"	5 1/8"
10"	9 5/8"	13"	2 1/2"	4"	6 1/2"
12"	11 5/8"	16"	2 7/8"	4 5/8"	7 1/2"

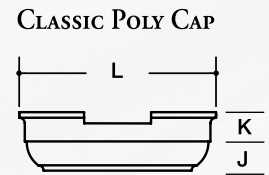
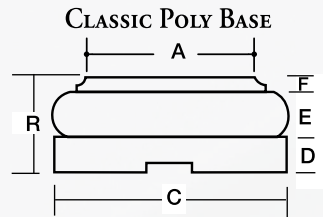

CLASSIC POLY CAP AND BASE DIMENSIONS

BASE	A	C	D	E	F	R	CAP	J	K	L
8"	7"	10 1/4"	1 7/8"	1 3/4"	5/8"	4 1/4"	8"	1 1/16"	1 5/16"	8 7/8"
10"	9"	12 7/8"	2 7/16"	2 1/8"	3/4"	5 5/16"	10"	1 1/4"	1 3/4"	10 5/8"
12"	11 5/8"	16"	2 7/8"	2 3/8"	7/8"	6 1/8"	12"	1 3/4"	2 1/16"	13 3/4"

CUSTOM SPLITTING OPTIONS

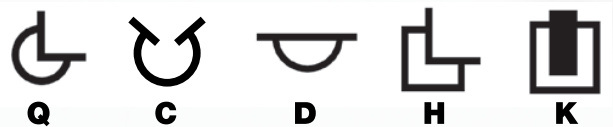

(items are approximate scale only)

NON-STOCK
SPECIAL ORDER ITEM

Square Aluminum Columns

Heritage, Legend, and Elite Square Aluminum Columns

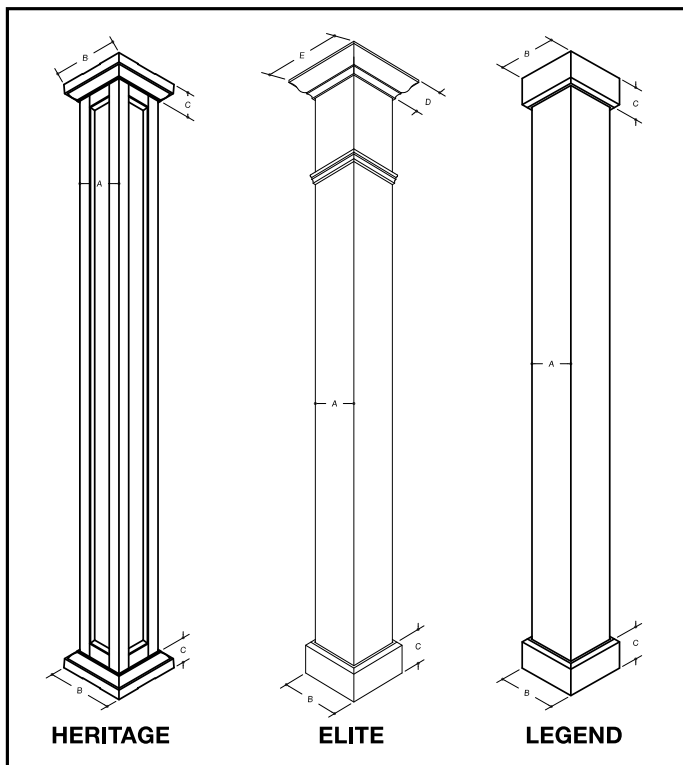

HERITAGE ELITE LEGEND

WHITE RECESSED PANEL HERITAGE COLUMN					
Nominal Size	STD. Lengths	A	B	C	
6"	8', 9', 10'	5-1/2"	8-1/2"	2-3/4"	
8"	8', 9', 10'	7-1/2"	10-1/2"	2-3/4"	

TEXTURED PLAIN ELITE COLUMN						
Nominal Size	STD. Lengths	A	B	C	D	E
6"	8', 9', 10'	5-1/2"	7-1/4"	5"	3"	10-1/2"
8"	8', 9', 10'	7-1/2"	9-1/4"	5"	3"	12-1/2"

TEXTURED PLAIN LEGEND COLUMN				
Nominal Size	STD. Lengths	A	B	C
6"	8', 9', 10'	5-1/2"	7-1/4"	5"
8"	8', 9', 10'	7-1/2"	9-1/4"	5"



Aluminum Columns

NON-STOCK
SPECIAL ORDER ITEM

(items are approximate scale only)

TRADITIONAL SQUARE ALUMINUM COLUMNS

- Pre-Finished • Load Bearing • Low Maintenance • Available in Fluted, Recessed Panel, or Plain

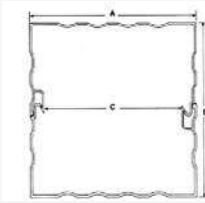
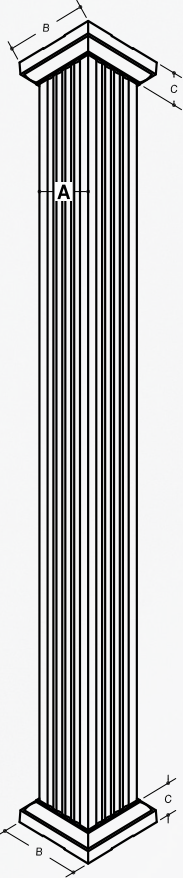
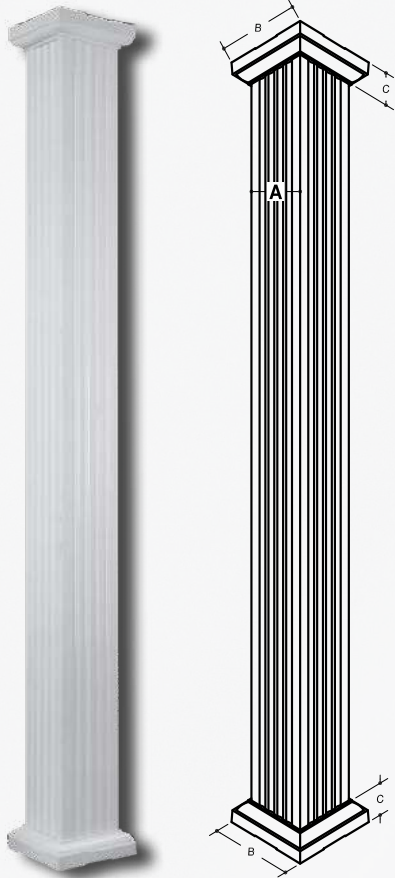

4", 6", and 8" columns have two staves each.

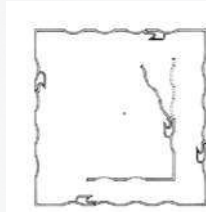

10" Columns have four staves each.

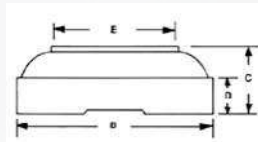

Standard Cast Aluminum Cap and Base

WHITE SQUARE FLUTED COLUMN DIMENSIONS				
Col. Size	# of Staves	A	B	C
4"	2	4-1/4"	6-1/4"	1-7/8"
6"	2	5-1/2"	8-1/4"	2-3/4"
8"	2	7-1/2"	10-3/16"	2-3/4"
10"	4	9-3/8"	12-1/4"	3"

CAP AND BASE DIMENSIONS				
Col. Size	B	C	D	E
4"	6-1/4"	1-7/8"	15/16"	4-3/8"
6"	8-1/4"	2-3/4"	1-1/2"	5-9/16"
8"	10-3/16"	2-3/4"	1-1/2"	7-9/16"
10"	12-1/4"	3"	1-11/16"	9-7/16"

AVAILABLE SIZES	
4" x 8'	8" x 8'
4" x 10'	8" x 9'
6" x 8'	8" x 10'
6" x 9'	10" x 8'
6" x 10'	10" x 9'
	10" x 10'



WHITE FLUTED ROUND ALUMINUM COLUMN

Round fluted aluminum columns are no-taper and have been designed to provide a lifetime of structural integrity. Columns are pre-finished and load bearing.

STANDARD CAPS AND BASES (Dimensions in inches on columns and bases)					
Col. Dia.	A	B	C	D	E
6"	5-3/4	6-1/16	7-1/2	2-1/8	1-1/16
8"	7-5/8	8	10	2-11/16	1-1/4
10"	9-9/16	10	12-1/2	3-3/8	1-5/8
12"	11-7/16	12	15	4	2

DIMENSION DATA IN INCHES				
Col. Dia.	# Staves in Whole Column	# Staves in 1/2 Column	Column O.D.	Column I.D.
6"	3	2	5-3/4	4-15/16
8"	3	2	7-3/4	7
10"	4	2	9-9/16	8-3/4
12"	5	3	11-7/16	10-5/8

AVAILABLE SIZES
6" x 8'
6" x 9'
6" x 10'
8" x 8'
8" x 9'
8" x 10'
10" x 8'
10" x 9'
10" x 10'
12" x 8'
12" x 9'
12" x 10'
12" x 12'

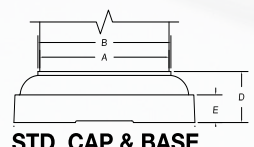
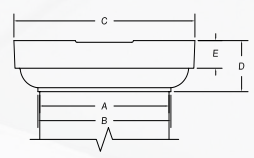

STD. CAP & BASE



(items are approximate scale only)

NON-STOCK
SPECIAL ORDER ITEM

PermaPosts® / Perma Lamp Posts

The Square PermaPost® is made from low maintenance PVC and is pre-finished with a white capstock. HB&G's Colonial and Chamfered PermaPost® are made from a low maintenance polyethylene and are pre-finished

white. For a warm and inviting decorative look for your front porch, choose from either the 5" or 6" Colonial PermaPost®, the 5" Square PermaPost®, or the 6" Chamfered PermaPost®.

PermaPosts®

Perma Lamp Posts

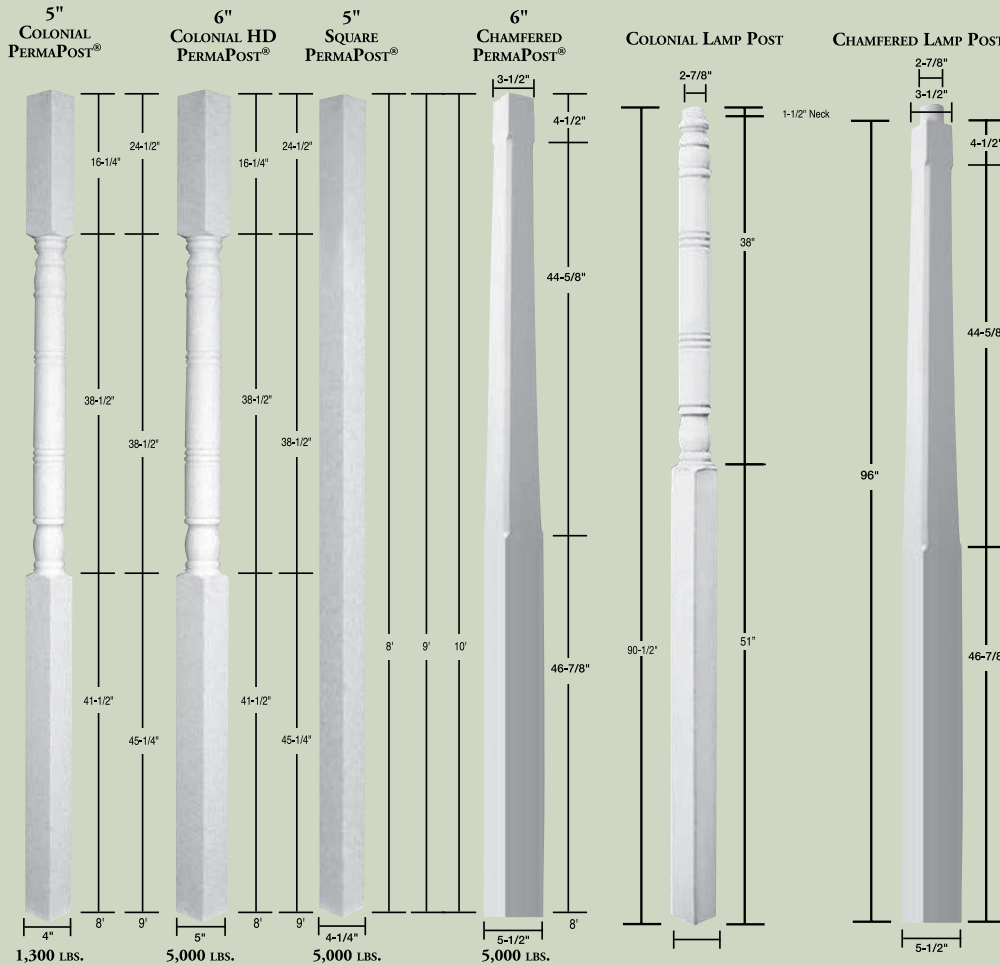

The Perma Lamp Post is an attractive way to light a drive or garden area. The pipe in the center is designed to allow a wire to be easily installed. The 2 7/8" pipe fits most outdoor lamp fixtures. New pre-finished injection molded skirts will be available in the spring.

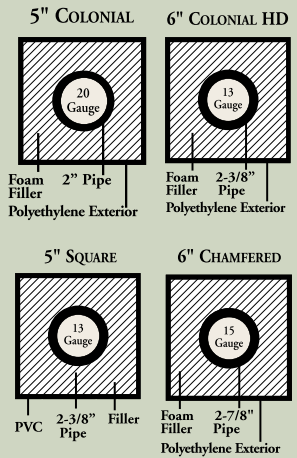

Porch-Loc™

- Adds wind uplift resistance
- Porch-Loc™ secures structural Colonial and Square PermaPost® to floor and beam/header
- Easy installation
- Durable skirts included

AVAILABLE IN 3 SIZES

SIZE	Dimension
5" Colonial	4"
6" Colonial	5"
5" Square	4-1/4"

Skirts and hardware included



Description

Dimensions are nominal and may vary slightly.

- 5" Colonial PermaPosts® and Perma Lamp Posts are net 4".
- 6" Colonial PermaPosts® are net 5".

Chamfered PermaPosts® and Perma Lamp Posts are net 3-1/2" (top) and 5-1/2" (bottom)

- Square posts are net 4-1/4".
- Perma Lamp Posts can accommodate most outdoor lamp fixtures.

New pre-finished injection molded skirts will be available in the spring.

FASTENING SYSTEMS

COLONIAL POST

Two (2) Post Fasteners are shipped with each colonial post.

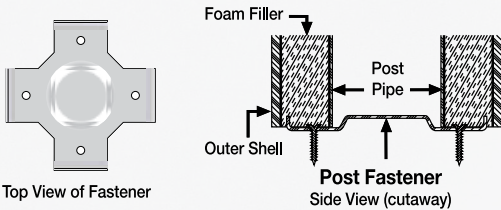

SQUARE POST

Two (2) Post Fasteners are shipped inside each post.

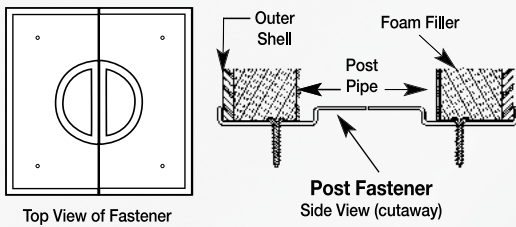

Optional Synthetic Post Fastening Kits

Each kit comes complete with skirt, brackets, and TapCon screws for wood or concrete substrates. Available for all Synthetic Post styles.

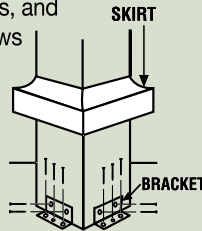

VINYL POST WRAP

NON-STOCK
SPECIAL ORDER ITEM

- Designed to Dress up a Treated Square Wood Post
- Low Maintenance
- Insect and Weather Proof
- Installs in Minutes
- Perfect for Remodeling
- Limited Lifetime Warranty
- Pre-Finished White



SIZES: 4"x 8.5', 4"x 10', 6"x 8.5', and 6"x 10'

EASY INSTALLATION

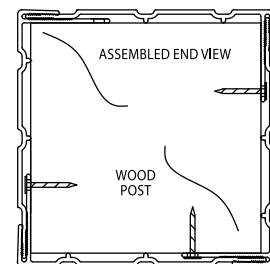

NON-STOCK
SPECIAL ORDER ITEM

WOOD PORCH POSTS

NUMBER 100 TURNED WOOD POST

Our No. 100 turned wood posts are available in 4", 5", and 6" nominal sizes.

(Cross sections are 3-1/4", 4-1/4", and 5-1/4" net size.)

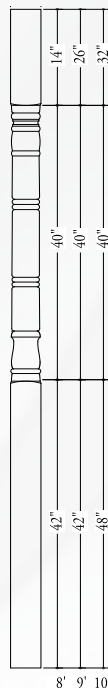

NUMBER 100
TURNED POST

ALUMINUM PLINTH FOR WOOD POST

Wood posts must be installed with aluminum plinths or quick mount bracket to comply with warranty.

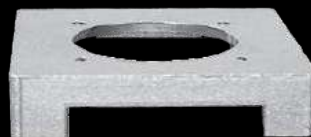

(items are approximate scale only)

PermaPost® Brackets

Brackets

NON-STOCK
SPECIAL ORDER ITEM

HB&G Polyurethane Brackets provide an inexpensive and low maintenance way to dress up your home. Choose from a wide variety of styles.

Brackets can be used with either PermaPosts® or wood posts. Enjoy a low-maintenance way to add style and decor to your front porch.



Adams

H-17¼"; W-2¾"; P-13¼"
70720



Bridgeport

H-15¼"; P-15¼"
70860



Chelsea
Wood

H-13¾"; P-13"
70840



Chippendale

H-14¾"; P-14¾"
70770



Drury Lane

IN STOCK

H-12½"; P-10¼"
70890



Floral
Bracket

IN STOCK

H-13¼"; P-10"
70500



Hessian

H-15¾"; P-15¾"
70820



Lady
Lucille

H-13¾"; W-2½"; P-9¼"
70710



Lions Gate

IN STOCK

H-15"; P-14"
70740



Portsmouth

H-13½"; P-13½"
70810



Princess
Anne

H-14½"; W-4"; P-9¼"
70610



Princess
of Wales

H-19"; P-15"
70520



Roanoke
House

H-16"; P-9¼"
70735



Seaside
Bracket

H-11¹³/₁₆"; P-11¹³/₁₆"
70750



Smithson

H-15³/₈"; P-15³/₈"
70850



Victoria

H-15"; W-4"; P-9½"
70510



Sun Rays

IN STOCK

H-12¼"; P-12¼"
70730



Townsend

IN STOCK

H-9⁸/₁₆"; W-3½"; P-6¾"
70800



Trillium

H-22⁷/₁₆"; P-13¼"
70790



Saint
Martin

H-14¹/₁₆"; P-12¹/₁₆"
70550



Seaside
Centerpiece

H-5⁷/₈"; L-20½"
70760



Fleur de lis
Centerpiece

H-7¹⁵/₁₆"; L-24"
70725



Waverly
Centerpiece

H-6"; L-20"
70880



Belle Grande
Centerpiece

H-5¹⁵/₁₆"; L-24¼"
70780



Victoria
Centerpiece

H-5³/₈"; W-2"; L-20"
70870



PermaPorch® Railing NON-STOCK SPECIAL ORDER ITEM

(items are approximate scale only)

The PermaPorch® Railing system is a beautiful way to tie your whole porch look together. It is made up of several different components, allowing you the ability to create the designs that match your way of life. Easy to install, this

worry free railing system will be a beautiful, low maintenance addition to your porch or deck for generations to come. Be sure to use the coastal newel in areas where coastal effect corrosion is a concern.

Porch Railing

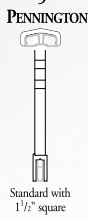

Deck Railing

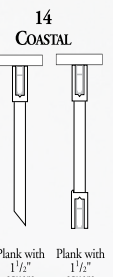
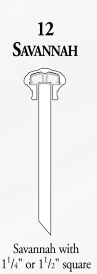
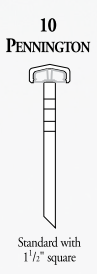
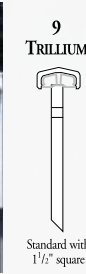
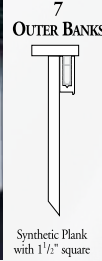

All rail sections suitable with columns (as shown) or PermaPost®
 * Top Rail Section must be installed on site.

Pre-Built PermaPorch® Railing

Pre-Built PermaPorch® Railing is available in a variety of styles to match your porch and deck design. The top and bottom rails are made of pre-finished weather resistant cellular PVC with aluminum inserts.

• HB&G recommends checking all building codes before the design and installation of your PermaPorch® Railing.

(items are approximate scale only)

NON-STOCK
SPECIAL ORDER ITEM

Rail Panels / Balusters

The top rail, bottom rail, and balusters are available in pre-finished white. They are made from weather resistant cellular PVC. The balusters are also available in round aluminum.

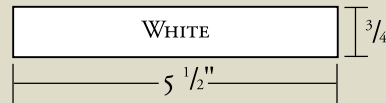
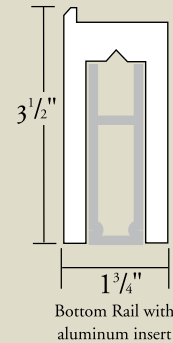
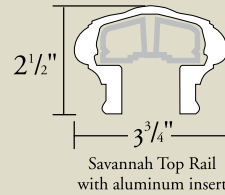
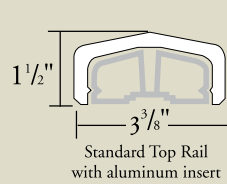

1/4"
Square
29 1/4", 32",
36" & 10'



1/2"
Square
32", 36"
& 10'



1/2"
Square
38", 44"
with 45°
end



3/8"
White
Aluminum
Baluster
28", 34"

Standard and Coastal* Square Newel
Post Mount System

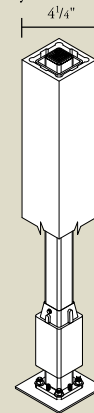
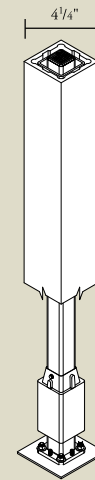

Chesterfield
Newel

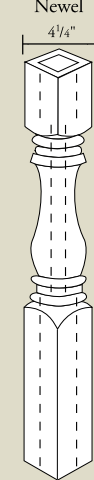

*Coastal Newel Post is designed to be used in harsh and coastal conditions.

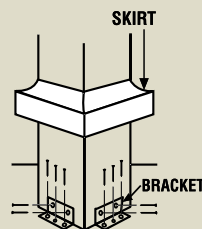

CHESTERFIELD FASTENING KIT*

Each kit comes complete with skirt, brackets, and TapCon screws for wood or concrete substrates.

*Review building code requirements prior to use.

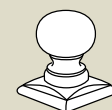

Poly Ball Top
Height 6"
Width at Base 4 1/8"

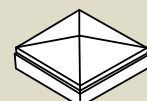

Poly Pyramid Top
Height 1 1/4"
Width at Base 4 1/8"

CUSTOM RAIL PANELS

Custom rail panels are available. Use our custom rail patterns to create a beautiful, one of a kind look that will set any home apart. HB&G's rail panels are designed to work with the PermaPorch® Railing top and bottom rails. They are made of cellular PVC and can be manufactured using your design or you can choose from one of the styles below. Contact a customer service representative now to order your custom rail panel.

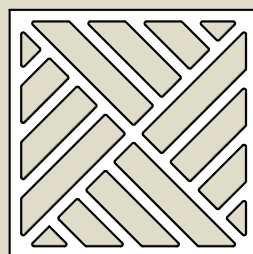

Chippendale

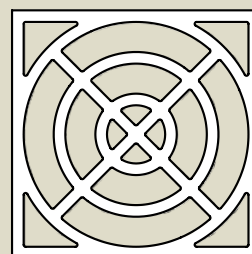

Circle Center

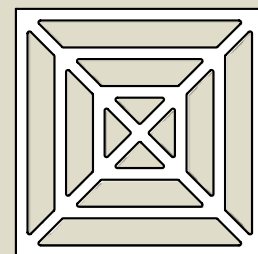

Spiderweb

Savannah PermaPorch® Railing
and 5" Square PermaPost®



Three Ways to Order the PermaPorch® Railing...

1. PRE-BUILT SECTIONS

- Shipped factory assembled
- Easy to install
- Everything needed to install is included
- How to order
 - Choose length – 4', 6', or 8' sections
 - Choose desired style from page 33 and 34
 - Note rail height (36" or 42")
- Onsite trimming ensures exact fit

2. DO-IT-YOURSELF KIT

- Rail Section shipped in one box
- Balusters are included in box*
- Everything needed to assemble and install is included
- How to order:
 - Choose length – 6' or 8'
 - Choose style – Savannah or Standard
- Kit includes:
 - Savannah or Standard top rail
 - Bottom rail
 - Aluminum inserts
 - 1 1/2" x 29 1/4" square balusters
 - 8' = 18 balusters
 - 6' = 14 balusters
 - Assembly and installation hardware
 - Support block
- Available in 36" rail height only

*Screws for balusters are not included

3. INDIVIDUAL COMPONENTS

- Build your own design
- Mix and match components
- For a complete rail system you will need the following:
 - Top rail – Standard or Savannah
 - Top insert – aluminum 8', 10', 12'
 - Balusters – 29 1/4", 32", 36", and 10' (Balusters may need to be trimmed for desired rail height.)
 - Bottom rail
 - Bottom insert – aluminum 8', 10', 12'
 - Support block
 - Fastening kit

TYPICAL ASSEMBLIES

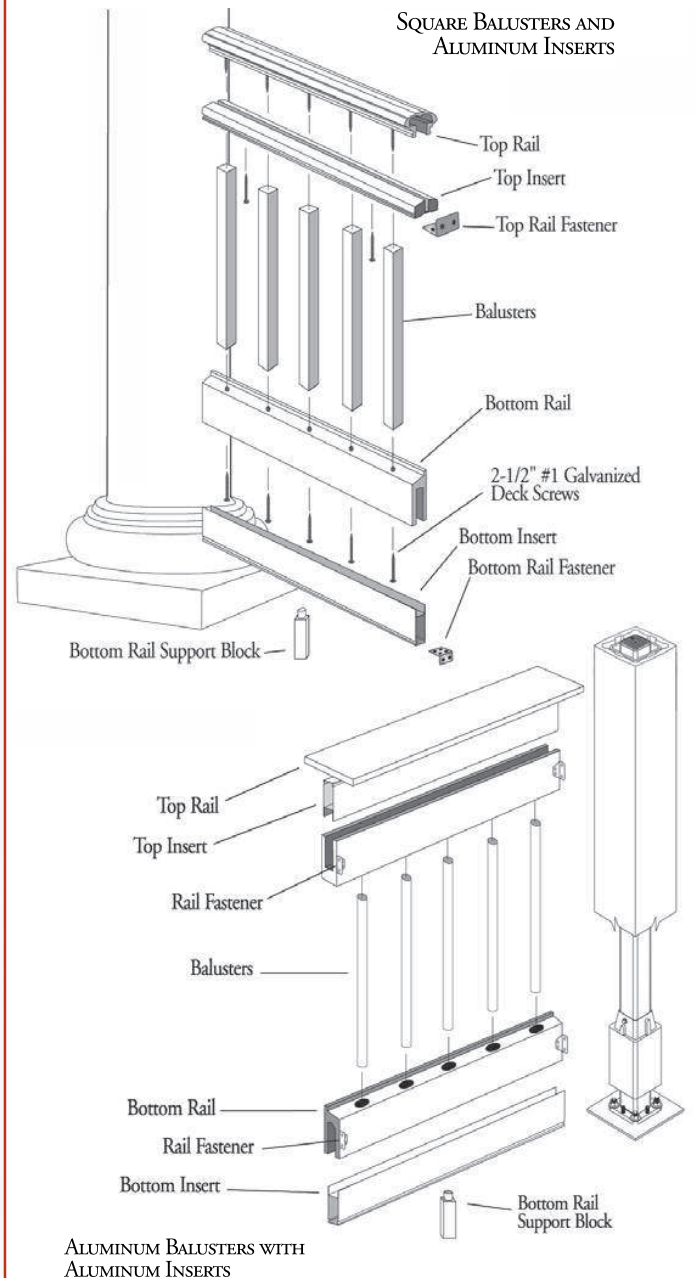

CURVED PERMAPORCH® RAILING

HB&G has a wide range of PermaPorch® Railing styles and designs. With the curved PermaPorch® Railing, HB&G's line of rail products can meet the needs of any application. The curved PermaPorch® Railing is available with either the Standard or Savannah top rail with wood inserts. Radius from 60" to 240" are available in 8 foot sections. Balusters sold separately. For lead time and ordering info, call 1-800-264-4HBG (4424).

HB&G recommends checking all building codes before the design and installation of your PermaPorch® railing.



Savannah

Standard

Big Ideas

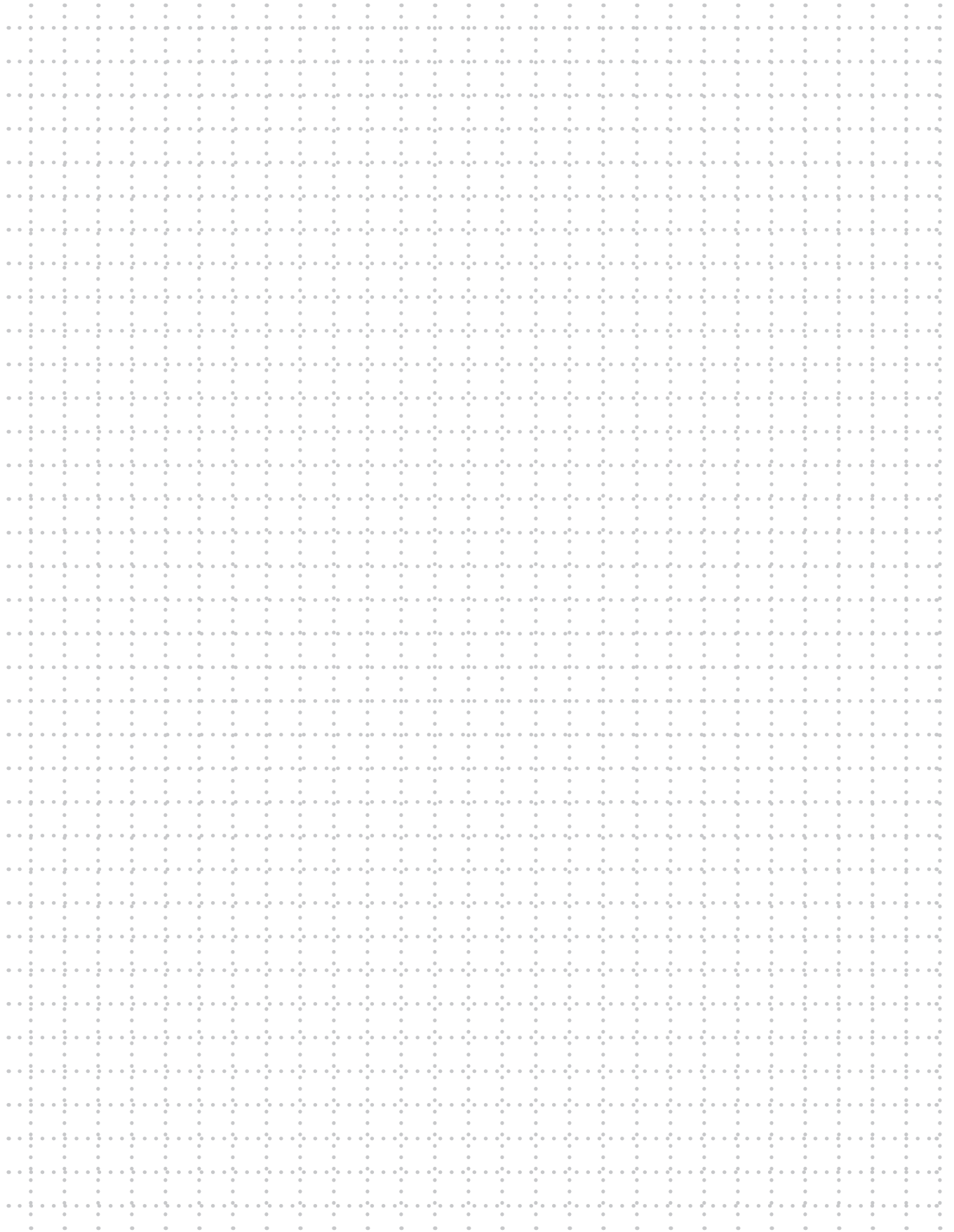

Big Ideas

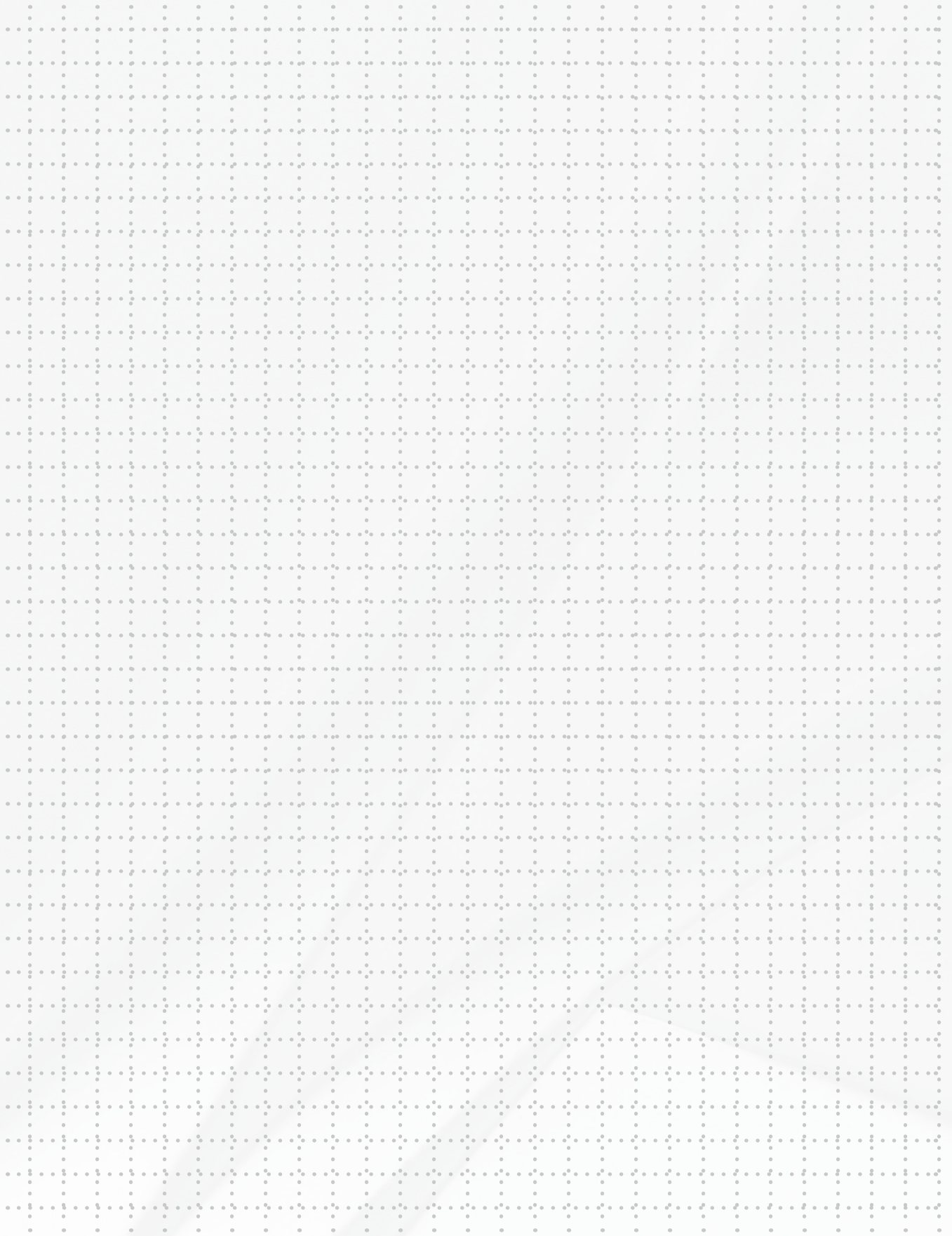

Fypon Beams & Corbels

RUSTIC BEAUTY MEETS MODERN PERFORMANCE



RUSTIC TEXTURES

Most of the products in the Rustic Collection have a texture that resembles sand-blasted cedar. The following products are exceptions. Close-ups of their textures are shown.

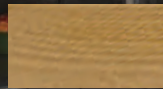

Milled Style Beams

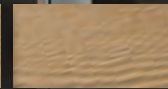

Mesa Style Beams



Tahoe Style Beams

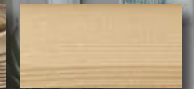

Louvers

Made of durable, high-performance polyurethane with an authentic wood grain texture, the Rustic Collection combines the look of real wood with the durability of urethane. From shutters to corbels to rafter tails and beams, you'll create a distinctive look that can weather the elements. The real beauty is that the Rustic Collection resists warping, splitting, moisture and insect infestation.

section contents

RUSTIC COLLECTION:

Beams	49
Beam-Plates & Straps	55
Brackets	75
Crossheads	87
Corbels	78
Knee Braces	77
Rafter Tails	84
Shutters	58
Shutter Accessories	71
Straps	55
Window & Door Trim	86

SMOOTH POLYURETHANE:

Ceiling Medallions	90
Corbels	88
Crown	89
Louvers	88
Pilasters	88

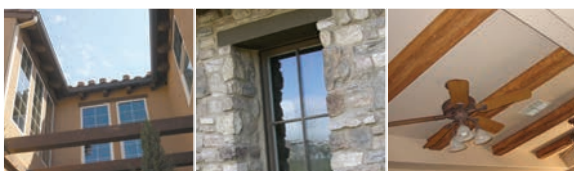

Fypon Beams & Corbels

I/E

DESIGN STYLES

TRADITIONAL | RUSTIC | SOUTHWEST

**JANKA
HARDNESS**
(POUNDS-FORCE)

N/A

INSTALLING & FINISHING POLYURETHANE

Fastening

- 1 Proper fastening is important in limiting the effects of expansion and contraction on the product.
- 2 Power nailers work well with this product but should be adjusted to prevent over driving the fastener into the material. This will prevent excessive nail pressure which can result in cracking.

Painting

Fypon products may be painted with any good quality latex paint. Usually one coat is all that is needed. They are also suitable for many faux finishing techniques, including sponging, feathering and antiquing.

Staining

Fypon Timber products are noted

as Woodgrain/Stainable and may be stained with a good quality, non-penetrating stain. Apply stain with a 2" natural bristle brush. Begin with a circular motion, then feather the stain in the direction of the grain. For a darker finish, apply a heavy coat of stain with light pressure. For a lighter finish, apply a thin coat of stain with more pressure.

Expansion & Contraction

- 1 This product expands and contracts with changes in temperature. To minimize this characteristic the recommendations given in the Fastening section should be followed.
- 2 When installing this product allow 3/16" per 18' for expansion and contraction. It is recommended that all joints be glued and where possible, fastened to the substrate to prevent joint separation.

INSTALLING & FINISHING PVC

Installing

- 1 Each piece has a consistent quality and finish, which requires no sanding, priming or sealing.
- 2 Joints between boards and sheets can easily be bonded with Devcon TrimBonder adhesive to prevent separation of joints.

Density is similar to hickory or white pine with a consistent core good for routing and can be cut and routed with standard woodworking tools.

Painting

The surface has a consistent quality and finish that never needs painting - no sanding, priming or sealing. These products may be painted to achieve desired color but is not required. Since PVC is a thermoplastic polymer, it must be painted with a paint that has a Light Reflectance Value (LRV) of 55% or higher.

There are many special formulated paint systems that will allow dark paint colors to be applied to PVC with low heat absorption.

Contact your local paint supplier for more details on painting specifications for PVC surfaces.

ALWAYS TEST TO MAKE SURE YOUR MEASURING TOOLS ARE ACCURATE. IF YOU ARE WORKING WITH A HELPER, TAKE A MEASUREMENT WITH ONE TOOL WHILE YOUR HELPER MEASURES WITH ANOTHER AND COMPARE YOUR RESULTS.

HELPFUL HINTS

- * Fypon products can be **cut, drilled or routed** similar to wood products.
- * For best results, always use **non-corrosive finish nails or screws** in combination with urethane compatible Adhesive or equivalent product.
- * **Proper Adhesive** should be applied to all contact points, including joint ends.
- * Polyurethane millwork should be **stored on a flat, level surface** in a cool, shaded area, and should not be stored in extreme heat.
- * Millwork that has been stored in a hot place should be **allowed to acclimate** to the installation area. Due to urethane's high insulating value, this may take up to 10 hours.
- * Urethane and PVC complement each other and can be easily used together. They both have similar performance benefits in that they **won't split, chip, or flake**.
- * Fypon's PVC products have a **core density between 32 - 43** pounds per cubic foot, similar to hickory, and have the same working characteristics as white pine.
- * Urethane has a **core density of 10 - 22** pounds per cubic foot, similar to that of white pine, and our process provides a greater skin density than core density.



QUICKRAIL PRODUCTS SHOULD NEVER BE PAINTED. TO DO SO WILL VOID THE LIMITED LIFETIME WARRANTY.



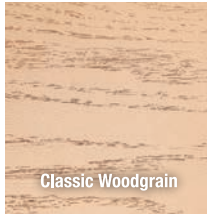

Classic Woodgrain



Milled Style



Standard Woodgrain



Tahoe Style



Rough Sawn Style

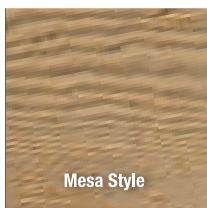

Mesa Style



Hand Hewn Style



Stone

FYPON

Where style meets performance

Style + Performance + Service = The Fypon Advantage

Fypon gives design and construction professionals an edge over all other interior and exterior design building materials. Fypon marries style and performance with one of the industry's largest product offerings and best customer service to give our customers a true competitive edge.

FYPON STYLE

Fypon is the recognized leader in polyurethane product design, innovation and molding technology. From old world style to classic modern design, Fypon offers the largest and most architecturally correct collection of styles and designs for moulding and trim, and now shutters and beams.

- Architecturally correct and historically accurate product styles and designs
- Molded from actual timber and stone products to capture the texture, patterns and deep shadow lines of classic building materials
- A distinctive look and personality to complement any home design for maximum appeal

FYPON PERFORMANCE

Only Fypon engineers consistent quality and long lasting performance into every product we make, today and tomorrow. From our popular trim and mouldings to our growing shutter and beam offerings, each product is manufactured by experts in polyurethane molding technology. All Fypon building products:

- Are easy to install with no special tools or extra labor necessary
- Deliver consistent workmanship and product quality
- Feature low maintenance
- Provide weather and moisture resistance
- Come stain or paint ready
- Resist insects and won't warp, crack or split

FYPON SERVICE

From one leader to another, building professionals trust Fypon to deliver on the jobsite and to the bottom line.

- Fypon provides architects and builders with renderings and marketing support for blue prints and model homes
- Receive extensive builder support, including an industry-first quote package program with quantity pricing tools available at CPS@fypon.com
- We provide installation FAQs (frequently asked questions) and support from master craftsmen
- Plus custom design services for historical restorations, replicas or any unique profile that fits your home or commercial application, available at CPS@fypon.com

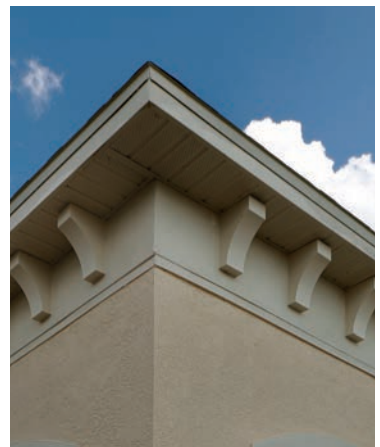
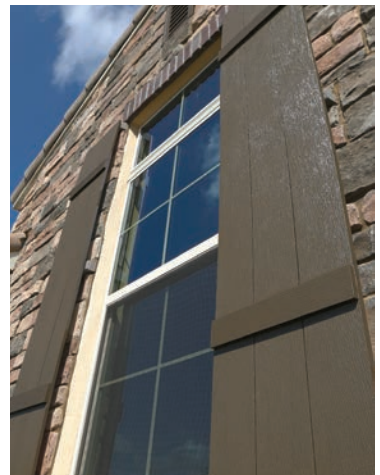

Beams

BEAMS



* Installed truss system can be viewed at MI Homes of Houston, McKenzie Park Model at 4922 Tres Lagos Drive - <http://www.mihomes.com/McKenzieTrusses>.



(items are approximate scale only)

Beams - Mesa

Beam - Mesa Redwood



WXH Nominal Dimensions	Actual Dimensions*	Side Wall Thickness*	Inside Top Width*	Inside Bottom Width*
4" X 6"	3 1/2" X 5 1/2"	3/4"	2"	1 5/8"
6" X 8"	5 1/2" X 7 1/2"	3/4"	4"	3 1/2"
8" X 10"	7 1/2" X 9 1/2"	3/4"	6"	5 3/8"
10" X 15"	9 1/8" X 14 3/4"	3/4"	7 5/8"	6 5/8"

Note: New beam inside dimensions are 1/4" wider to accommodate a standard 2" X 2", 2" X 4", 2" X 6", 2" X 8" blocking application. * +/- 1/4"



Note: Width and height are nominal, length is actual.

4" X 6" Part Number	6" X 8" Part Number	8" X 10" Part Number	10" X 15" Part Number	Additional Sizes
BMM4X6X96RDW	BMM6X8X96RDW	BMM8X10X96RDW	BMM10X15X234RDW*	Available in 24" increments, from 96" to 288"
BMM4X6X144RDW	BMM6X8X144RDW	BMM8X10X144RDW		
BMM4X6X120RDW	BMM6X8X120RDW	BMM8X10X120RDW		
BMM4X6X192RDW	BMM6X8X192RDW	BMM8X10X192RDW		
BMM4X6X240RDW	BMM6X8X240RDW	BMM8X10X240RDW		
BMM4X6X288RDW	BMM6X8X288RDW	BMM8X10X288RDW		

* Only available in 234".



Parts may be required to ship LTL (less than truckload) based on size and overall dimensions.



Beams - Tahoe

(items are approximate scale only)



Beam - Tahoe

Cedar



WXH Nominal Dimensions	Actual Dimensions*	Side Wall Thickness*	Inside Top Width*	Inside Bottom Width*
4" X 6"	3 1/2" X 5 1/2"	3/4"	2"	1 5/8"
6" X 8"	5 1/2" X 7 1/2"	3/4"	4"	3 1/2"
8" X 10"	7 1/2" X 9 1/2"	3/4"	6"	5 3/8"

Note: New beam inside dimensions are 1 1/4" wider to accommodate a standard 2" X 2", 2" X 4", 2" X 6", 2" X 8" blocking application. * +/- 1/4"

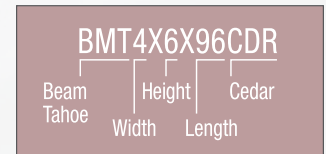

Note: Width and height are nominal, length is actual.

4" X 6" Part Number	6" X 8" Part Number	8" X 10" Part Number	Additional Sizes
BMT4X6X96CDR	BMT6X8X96CDR	BMT8X10X96CDR	Available in 24" increments, from 96" to 288"
BMT4X6X120CDR	BMT6X8X120CDR	BMT8X10X120CDR	
BMT4X6X144CDR	BMT6X8X144CDR	BMT8X10X144CDR	
BMT4X6X192CDR	BMT6X8X192CDR	BMT8X10X192CDR	
BMT4X6X240CDR	BMT6X8X240CDR	BMT8X10X240CDR	
BMT4X6X288CDR	BMT6X8X288CDR	BMT8X10X288CDR	



(items are approximate scale only)

Beams - Hand Hewn

Beam - Hand Hewn Elm



WXH Nominal Dimensions	Actual Dimensions*	Side Wall Thickness*	Inside Top Width*	Inside Bottom Width*
4" X 6"	3 1/2" X 5 1/2"	3/4"	2"	1 5/8"
6" X 8"	5 1/2" X 7 1/2"	3/4"	4"	3 1/2"
8" X 10"	7 1/2" X 9 1/2"	3/4"	6"	5 3/8"

Note: New beam inside dimensions are 1 1/4" wider to accommodate a standard 2" X 2", 2" X 4", 2" X 6", 2" X 8" blocking application. * +/- 1/8"

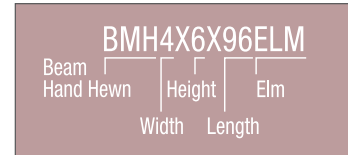

Note: Width and height are nominal, length is actual.

4" X 6" Part Number	6" X 8" Part Number	8" X 10" Part Number	Additional Sizes
BMH4X6X96ELM	BMH6X8X96ELM	BMH8X10X96ELM	Available in 24" increments, from 96" to 288"
BMH4X6X120ELM	BMH6X8X120ELM	BMH8X10X120ELM	
BMH4X6X144ELM	BMH6X8X144ELM	BMH8X10X144ELM	
BMH4X6X192ELM	BMH6X8X192ELM	BMH8X10X192ELM	
BMH4X6X240ELM	BMH6X8X240ELM	BMH8X10X240ELM	
BMH4X6X288ELM	BMH6X8X288ELM	BMH8X10X288ELM	



Parts may be required to ship LTL (less than truckload) based on size and overall dimensions.



Beams - Rough Sawn

(items are approximate scale only)



Beam - Rough Sawn

Cedar



WXH Nominal Dimensions	Actual Dimensions*	Side Wall Thickness*	Inside Top Width*	Inside Bottom Width*
4" X 6"	3 1/2" X 5 1/2"	3/4"	2"	1 5/8"
6" X 8"	5 1/2" X 7 1/2"	3/4"	4"	3 1/2"
8" X 10"	7 1/2" X 9 1/2"	3/4"	6"	5 3/8"

Note: New beam inside dimensions are 1 1/4" wider to accommodate a standard 2" X 2", 2" X 4", 2" X 6", 2" X 8" blocking application. * +/- 1/4"

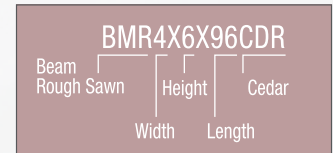

Note: Width and height are nominal, length is actual.

4" X 6" Part Number	6" X 8" Part Number	8" X 10" Part Number	Additional Sizes
BMR4X6X96CDR	BMR6X8X96CDR	BMR8X10X96CDR	<p>Available in 24" increments, from 96" to 288"</p>
BMR4X6X120CDR	BMR6X8X120CDR	BMR8X10X120CDR	
BMR4X6X144CDR	BMR6X8X144CDR	BMR8X10X144CDR	
BMR4X6X192CDR	BMR6X8X192CDR	BMR8X10X192CDR	
BMR4X6X240CDR	BMR6X8X240CDR	BMR8X10X240CDR	
BMR4X6X288CDR	BMR6X8X288CDR	BMR8X10X288CDR	



(items are approximate scale only)

Beam Plates / Beam Straps

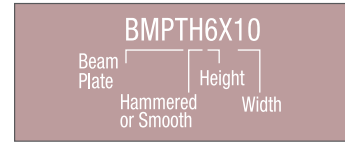

Beam Plates

	Smooth		Hammered		
	Part Number	Part Number	Part Number	Part Number	
	BMPTS6X10*	BMPTH6X10*			
	BMPTS8X10*	BMPTH8X10*		BMPTS36X36** <small>NON-STOCK SPECIAL ORDER ITEM</small>	BMPTH36X36** <small>NON-STOCK SPECIAL ORDER ITEM</small>
	BMPTS10X15*	BMPTH10X15*		BMPTS48X48** <small>NON-STOCK SPECIAL ORDER ITEM</small>	BMPTH48X48** <small>NON-STOCK SPECIAL ORDER ITEM</small>
	BMPTS15X20*	BMPTH15X20*			

*Nuts and bolts molded into beam plates, sold in packages of 2, front and back plate

**Beam plate can be cut to fit your specific project requirement.

Note: Nut and bolt heads are included (20 of each packaged separately).
Additional packs can be ordered separately (BMPPLTHDWKT40 = 20 nuts and 20 bolts, BMPPLTHDWKT20 = 10 nuts and 10 bolts, BMPPLTHDWKT10 = 5 nuts and 5 bolts).

Beam Straps

	Smooth		Hammered		
	Part Number	Beam Size	Part Number	Beam Size	
	BMSTRPS4X6	4" X 6"			
	BMSTRPS6X8	6" X 8"		BMSTRPH4X6	4" X 6"
	BMSTRPS8X10	8" X 10"		BMSTRPH6X8	6" X 8"
	BMSTRPS10X15	10" X 15"*		BMSTRPH8X10	8" X 10"
			BMSTRPH10X15	10" X 15"*	

Note: Width of beam strap is 6" for all beam sizes.

* Mesa only.



Parts may be required to ship LTL (less than truckload) based on size and overall dimensions.



Beams - Classic

(items are approximate scale only)



Beam - Classic

Smooth Cedar

	Part Number	Overall Width	Overall Height	Length	Inside Width	Inside Height
	BM4X5X192S <small>NON-STOCK SPECIAL ORDER ITEM</small>	6 5/8"	5"	16'	2 3/4"	4 1/4"

Note: For smooth beam options, please refer to smooth catalog.

(items are approximate scale only)

Beams - Milled

Beam - Milled *Smooth Cedar*

	Part Number	Overall Width	Overall Height	Length	Inside Width	Inside Height
	BMCDR4X3X168S <small>NON-STOCK SPECIAL ORDER ITEM</small>	3 1/2"	2 1/2"	14'	2"	1 3/4"
	BMCDR8X6X168S <small>NON-STOCK SPECIAL ORDER ITEM</small>	7 1/4"	5 3/4"	14'	5 3/4"	5"



Parts may be required to ship LTL (less than truckload) based on size and overall dimensions.



Rough Sawn Cedar Shutters

NON-STOCK
SPECIAL ORDER ITEM

ROUGH SAWN CEDAR SHUTTERS



Fypon woodgrain shutters

- Our expanded line includes multiple styles and sizes, with widths of 12", 14", 18", and 24", and heights from 24" to 120", available in 1" increments.
- Accessory line of hinges and clavos creates a distinct look for your shutters.
- Available in both board and batten and plank styles for the options you'd expect from Fypon, the style leader

BOARD & BATTEN – JOINED BOARD AND BATTEN STYLES



2 OR 3 BATTEN
Batten styles with joined boards



END BATTEN
Battens are placed at the very end of the boards



Z BATTEN
The horizontal battens, or cross Z, are placed on the front of the shutter



QUARTER ROUND
Shutters that mirror unique arch top windows



ELLIPTICAL
A shutter top that mirrors the shape of a unique elliptical window

PLANK – SPACED BOARDS CREATE VISIBILITY OF SIDING BETWEEN SHUTTER BOARDS



2 OR 3 BATTEN
Batten styles with spaced boards



Z BATTEN
The horizontal battens, or cross Z, are placed on the front of the shutter



DIAMOND
Decorative diamond shape is centered between the panels



ELLIPTICAL
A shutter top that mirrors the shape of a unique elliptical window

BOARD & BATTEN LOGIC PLANK LOGIC

SH3PC18X60RS

[Profile] SH = Shutter	[Texture] RS = Rough Sawn Stain or Paint
[Configuration]	[Height] (1" increments)
2PC = 2 Board, 2 Batten	24 = 24" [Minimum]
3PC = 3 Board, 2 Batten	120 = 120" [Maximum]
4PC = 4 Board, 2 Batten	
2P3BC = 2 Board, 3 Batten	[Width]
3P3BC = 3 Board, 3 Batten	12 = 12"
4P3BC = 4 Board, 3 Batten	14 = 14"
	18 = 18"
	24 = 24"

SH3PO18X60RS

[Profile] SH = Shutter	[Texture] RS = Rough Sawn Stain or Paint
[Configuration]	[Height] (1" increments)
2PO = 2 Plank, 2 Batten	24 = 24" [Minimum]
3PO = 3 Plank, 2 Batten	120 = 120" [Maximum]
4PO = 4 Plank, 2 Batten	
2P3B = 2 Plank, 3 Batten	[Width]
3P3B = 3 Plank, 3 Batten	12 = 12"
4P3B = 4 Plank, 3 Batten	18 = 18"
	24 = 24"

QUARTER ROUND LOGIC

SH3PHLR18X60RS

[Profile] SH = Shutter	[Texture] RS = Rough Sawn Stain or Paint
[Configuration]	[Height] (1" increments)
2PHLR = 2 Board Quarter	24 = 24" [Minimum]
3PHLR = 3 Board Quarter	120 = 120" [Maximum]
4PHLR = 4 Board Quarter	
	[Width]
	12 = 12"
	14 = 14"
	18 = 18"
	24 = 24"

Note: Minimum height for Quarter Round Shutters is double the width of the shutter.
Example: SH3PHLR18x36RS – 18" = width of shutter and 36" = height (twice the width).

12" Board & Batten Shutters

(items are approximate scale only)

Additional Sizes Available

Shutter height available in 1" increments, 24"-120", available at standard lead time. See price pages for individual part numbers.

12" Board & Batten Shutters

Rough Sawn Cedar

NON-STOCK
SPECIAL ORDER ITEM

2 Board, 2 Batten

2 Board, 3 Batten

2 Board, End Batten

Part Number	Part Number	Part Number
SH2PC12X24RS	SH2P3BC12X24RS	SH2PEBC12X24RS
SH2PC12X36RS	SH2P3BC12X36RS	SH2PEBC12X36RS
SH2PC12X48RS	SH2P3BC12X48RS	SH2PEBC12X48RS
SH2PC12X60RS	SH2P3BC12X60RS	SH2PEBC12X60RS
SH2PC12X72RS	SH2P3BC12X72RS	SH2PEBC12X72RS
SH2PC12X84RS	SH2P3BC12X84RS	SH2PEBC12X84RS
SH2PC12X96RS	SH2P3BC12X96RS	SH2PEBC12X96RS
SH2PC12X108RS	SH2P3BC12X108RS	SH2PEBC12X108RS
SH2PC12X120RS	SH2P3BC12X120RS	SH2PEBC12X120RS



(items are approximate scale only)

12" Board & Batten Shutters



12" Board & Batten Shutters

Rough Sawn Cedar Continued

**NON-STOCK
SPECIAL ORDER ITEM**

2 Board, Z Batten

2 Board, Quarter Round

	Part Number		Part Number
	SH2PZC12X24RS		SH2PHLR12X24RS
	SH2PZC12X36RS		SH2PHLR12X36RS
	SH2PZC12X48RS		SH2PHLR12X48RS
	SH2PZC12X60RS		SH2PHLR12X60RS
	SH2PZC12X72RS		SH2PHLR12X72RS
	SH2PZC12X84RS		SH2PHLR12X84RS
	SH2PZC12X96RS		SH2PHLR12X96RS
	SH2PZC12X108RS		SH2PHLR12X108RS
	SH2PZC12X120RS		SH2PHLR12X120RS

Parts may be required to ship LTL (less than truckload) based on size and overall dimensions.



14" Board & Batten Shutters

(items are approximate scale only)



Additional Sizes Available

Shutter height available in 1" increments, 24"-120", available at standard lead time. See price pages for individual part numbers.

14" Board & Batten Shutters

Rough Sawn Cedar

NON-STOCK
SPECIAL ORDER ITEM

3 Board, 2 Batten		3 Board, 3 Batten		3 Board, End Batten	
	Part Number		Part Number		Part Number
	SH3PC14X24RS		SH3P3BC14X24RS		SH3PEBC14X24RS
	SH3PC14X36RS		SH3P3BC14X36RS		SH3PEBC14X36RS
	SH3PC14X48RS		SH3P3BC14X48RS		SH3PEBC14X48RS
	SH3PC14X60RS		SH3P3BC14X60RS		SH3PEBC14X60RS
	SH3PC14X72RS		SH3P3BC14X72RS		SH3PEBC14X72RS
	SH3PC14X84RS		SH3P3BC14X84RS		SH3PEBC14X84RS
	SH3PC14X96RS		SH3P3BC14X96RS		SH3PEBC14X96RS
	SH3PC14X108RS		SH3P3BC14X108RS		SH3PEBC14X108RS
	SH3PC14X120RS		SH3P3BC14X120RS		SH3PEBC14X120RS



(items are approximate scale only)

14" Board & Batten Shutters





14" Board & Batten Shutters

Rough Sawn Cedar Continued

NON-STOCK
SPECIAL ORDER ITEM

3 Board, Z Batten

3 Board, Quarter Round

	Part Number		Part Number
	SH3PZC14X24RS		SH3PHLR14X36RS
	SH3PZC14X36RS		SH3PHLR14X48RS
	SH3PZC14X48RS		SH3PHLR14X60RS
	SH3PZC14X60RS		SH3PHLR14X72RS
	SH3PZC14X72RS		SH3PHLR14X84RS
	SH3PZC14X84RS		SH3PHLR14X96RS
	SH3PZC14X96RS		SH3PHLR14X108RS
	SH3PZC14X108RS		SH3PHLR14X120RS
	SH3PZC14X120RS		

Parts may be required to ship LTL (less than truckload) based on size and overall dimensions.



18" Board & Batten Shutters

(items are approximate scale only)

Additional Sizes Available

Shutter height available in 1" increments, 24"-120", available at standard lead time. See price pages for individual part numbers.

18" Board & Batten Shutters

Rough Sawn Cedar

NON-STOCK
SPECIAL ORDER ITEM

3 Board, 2 Batten

Part Number
SH3PC18X24RS
SH3PC18X36RS
SH3PC18X48RS
SH3PC18X60RS
SH3PC18X72RS
SH3PC18X84RS
SH3PC18X96RS
SH3PC18X108RS
SH3PC18X120RS

3 Board, 3 Batten

Part Number
SH3P3BC18X24RS
SH3P3BC18X36RS
SH3P3BC18X48RS
SH3P3BC18X60RS
SH3P3BC18X72RS
SH3P3BC18X84RS
SH3P3BC18X96RS
SH3P3BC18X108RS
SH3P3BC18X120RS

3 Board, End Batten

Part Number
SH3PEBC18X24RS
SH3PEBC18X36RS
SH3PEBC18X48RS
SH3PEBC18X60RS
SH3PEBC18X72RS
SH3PEBC18X84RS
SH3PEBC18X96RS
SH3PEBC18X108RS
SH3PEBC18X120RS

3 Board, Z Batten

Part Number
SH3PZC18X24RS
SH3PZC18X36RS
SH3PZC18X48RS
SH3PZC18X60RS
SH3PZC18X72RS
SH3PZC18X84RS
SH3PZC18X96RS
SH3PZC18X108RS
SH3PZC18X120RS

3 Board, Quarter Round

Part Number
SH3PHLR18X36RS
SH3PHLR18X48RS
SH3PHLR18X60RS
SH3PHLR18X72RS
SH3PHLR18X84RS
SH3PHLR18X96RS
SH3PHLR18X108RS
SH3PHLR18X120RS

(items are approximate scale only)

24" Board & Batten Shutters

Additional Sizes Available

Shutter height available in 1" increments, 24"-120", available at standard lead time. See price pages for individual part numbers.

24" Board & Batten Shutters

Rough Sawn Cedar

NON-STOCK
SPECIAL ORDER ITEM

4 Board, 2 Batten

Part Number
SH4PC24X24RS
SH4PC24X36RS
SH4PC24X48RS
SH4PC24X60RS
SH4PC24X72RS
SH4PC24X84RS
SH4PC24X96RS
SH4PC24X108RS
SH4PC24X120RS



4 Board, 3 Batten

Part Number
SH4P3BC24X24RS
SH4P3BC24X36RS
SH4P3BC24X48RS
SH4P3BC24X60RS
SH4P3BC24X72RS
SH4P3BC24X84RS
SH4P3BC24X96RS
SH4P3BC24X108RS
SH4P3BC24X120RS



4 Board, End Batten

Part Number
SH4PEBC24X24RS
SH4PEBC24X36RS
SH4PEBC24X48RS
SH4PEBC24X60RS
SH4PEBC24X72RS
SH4PEBC24X84RS
SH4PEBC24X96RS
SH4PEBC24X108RS
SH4PEBC24X120RS

4 Board, Z Batten

Part Number
SH4PZC24X24RS
SH4PZC24X36RS
SH4PZC24X48RS
SH4PZC24X60RS
SH4PZC24X72RS
SH4PZC24X84RS
SH4PZC24X96RS
SH4PZC24X108RS
SH4PZC24X120RS

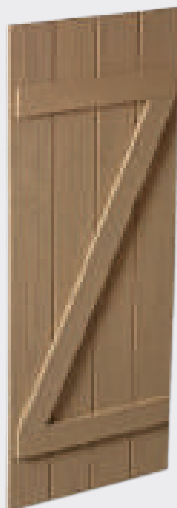

4 Board, Quarter Round

Part Number
SH4PHLR24X48RS
SH4PHLR24X60RS
SH4PHLR24X72RS
SH4PHLR24X84RS
SH4PHLR24X96RS
SH4PHLR24X108RS
SH4PHLR24X120RS



Parts may be required to ship LTL (less than truckload) based on size and overall dimensions.



12" Plank Shutters

(items are approximate scale only)



Additional Sizes Available

Shutter height available in 1" increments, 24"-120", available at standard lead time. See price pages for individual part numbers.

12" Plank Shutters

Rough Sawn Cedar

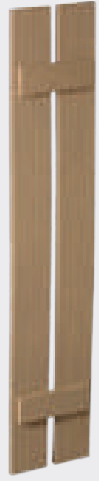

NON-STOCK
SPECIAL ORDER ITEM

2 Plank, 2 Batten		2 Plank, 3 Batten		2 Plank, Z Batten	
	Part Number		Part Number		Part Number
	SH2P012X24RS		SH2P3B12X24RS		SH2PZ12X24RS
	SH2P012X36RS		SH2P3B12X36RS		SH2PZ12X36RS
	SH2P012X48RS		SH2P3B12X48RS		SH2PZ12X48RS
	SH2P012X60RS		SH2P3B12X60RS		SH2PZ12X60RS
	SH2P012X72RS		SH2P3B12X72RS		SH2PZ12X72RS
	SH2P012X84RS		SH2P3B12X84RS		SH2PZ12X84RS
	SH2P012X96RS		SH2P3B12X96RS		SH2PZ12X96RS
	SH2P012X108RS		SH2P3B12X108RS		SH2PZ12X108RS
	SH2P012X120RS		SH2P3B12X120RS		SH2PZ12X120RS

18" Plank Shutters

Rough Sawn Cedar

NON-STOCK
SPECIAL ORDER ITEM

3 Plank, 2 Batten		3 Plank, 3 Batten		3 Plank, Z Batten	
	Part Number		Part Number		Part Number
	SH3P018X24RS		SH3P3B18X24RS		SH3PZ18X24RS
	SH3P018X36RS		SH3P3B18X36RS		SH3PZ18X36RS
	SH3P018X48RS		SH3P3B18X48RS		SH3PZ18X48RS
	SH3P018X60RS		SH3P3B18X60RS		SH3PZ18X60RS
	SH3P018X72RS		SH3P3B18X72RS		SH3PZ18X72RS
	SH3P018X84RS		SH3P3B18X84RS		SH3PZ18X84RS
	SH3P018X96RS		SH3P3B18X96RS		SH3PZ18X96RS
	SH3P018X108RS		SH3P3B18X108RS		SH3PZ18X108RS
	SH3P018X120RS		SH3P3B18X120RS		SH3PZ18X120RS

(items are approximate scale only)

24" Plank Shutters



24" Plank Shutters

Rough Sawn Cedar

NON-STOCK
SPECIAL ORDER ITEM

4 Plank, 2 Batten

4 Plank, 3 Batten

4 Plank, Z Batten

4 Plank, 2 Batten		4 Plank, 3 Batten		4 Plank, Z Batten	
Image	Part Number	Image	Part Number	Image	Part Number
	SH4P024X24RS		SH4P3B24X24RS		SH4PZ24X24RS
	SH4P024X36RS		SH4P3B24X36RS		SH4PZ24X36RS
	SH4P024X48RS		SH4P3B24X48RS		SH4PZ24X48RS
	SH4P024X60RS		SH4P3B24X60RS		SH4PZ24X60RS
	SH4P024X72RS		SH4P3B24X72RS		SH4PZ24X72RS
	SH4P024X84RS		SH4P3B24X84RS		SH4PZ24X84RS
	SH4P024X96RS		SH4P3B24X96RS		SH4PZ24X96RS
	SH4P024X108RS		SH4P3B24X108RS		SH4PZ24X108RS
	SH4P024X120RS		SH4P3B24X120RS		SH4PZ24X120RS



Elliptical Shutters - Board & Batten

(items are approximate scale only)



Additional Sizes Available

Shutter height available in 1" increments, 24"-120", available at standard lead time. See price pages for individual part numbers.

Elliptical Shutters - Board & Batten

Rough Sawn Cedar

NON-STOCK
SPECIAL ORDER ITEM

ELLIPTICAL BOARD & BATTEN LOGIC



SH3PEHLR18X50X54RS

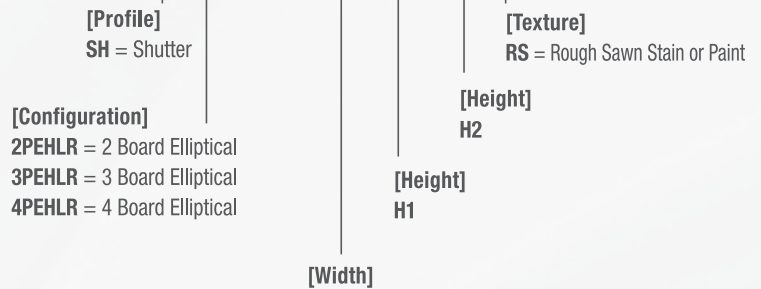

Note: If a specific radius is required to complement an elliptical shaped window, contact your customer service representative to order.

To order an elliptical shutter that complements the arch of the window, provide measurements of **H1** (in 1/4" increments) and **H2** (in 1" increments) in your part number. See drawing for specific measurement points.

Example:
SH3PEHLR18X50X56RS

W H1 H2

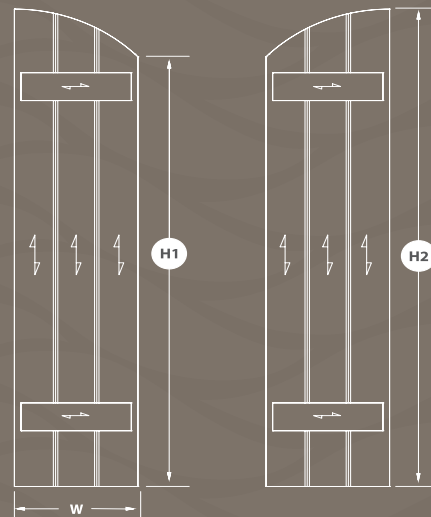

(items are approximate scale only)

Elliptical Shutters - Plank



Elliptical Shutters - Plank

Rough Sawn Cedar

NON-STOCK
SPECIAL ORDER ITEM

ELLIPTICAL PLANK LOGIC



SH3PE18X50X56RS

[Profile]
SH = Shutter

[Texture]

RS = Rough Sawn Stain or

[Configuration]

2PE = 2 Plank Elliptical

3PE = 3 Plank Elliptical

4PE = 4 Plank Elliptical

[Height]
H2

[Height]
H1

[Width]

Note: If a specific radius is required to complement an elliptical shaped window, contact your customer service representative to order.

To order an elliptical shutter that complements the arch of the window, provide measurements of **H1** (in 1/4" increments) and **H2** (in 1" increments) in your part number. See drawing for specific measurement points.

Example:

SH3PE18X50X56RS

W H1 H2

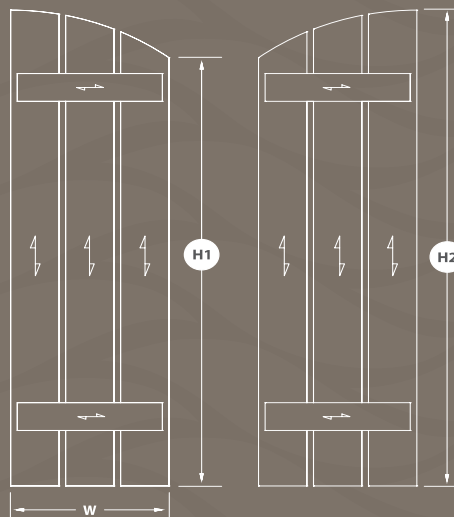

Diamond Plank Shutters

(items are approximate scale only)



Additional Sizes Available

Shutter height available in 1" increments, 24"-120", available at standard lead time. See price pages for individual part numbers.

Diamond Plank Shutters



Rough Sawn Cedar

NON-STOCK
SPECIAL ORDER ITEM

2 Plank, Diamond

3 Plank, Diamond

4 Plank, Diamond

2 Plank, Diamond		3 Plank, Diamond		4 Plank, Diamond	
	Part Number		Part Number		Part Number
	SH2PD12X24RS		SH3PD18X24RS		SH4PD24X24RS
	SH2PD12X36RS		SH3PD18X36RS		SH4PD24X36RS
	SH2PD12X48RS		SH3PD18X48RS		SH4PD24X48RS
	SH2PD12X60RS		SH3PD18X60RS		SH4PD24X60RS
	SH2PD12X72RS		SH3PD18X72RS		SH4PD24X72RS
	SH2PD12X84RS		SH3PD18X84RS		SH4PD24X84RS
	SH2PD12X96RS		SH3PD18X96RS		SH4PD24X96RS
	SH2PD12X108RS		SH3PD18X108RS		SH4PD24X108RS
SH2PD12X120RS	SH3PD18X120RS	SH4PD24X120RS			





(items are approximate scale only)

Shutters Accessories - Hinges / Clavos

Shutters Accessories - Hinges

NON-STOCK
SPECIAL ORDER ITEM

Colonial & Spear

	Part Number	Length		Part Number	Length
	SHHNGCOL10*	10"		SHHNGSPR10*	10"
	SHHNGCOL16*	16"		SHHNGSPR16*	16"

* Sold in packs of 2.

Shutters Accessories - Clavos

NON-STOCK
SPECIAL ORDER ITEM

Round & Pyramid

	Part Number	Diameter		Part Number	Width
	SHCLARND1.25*	1 1/4"		SHCLAPYR1.25*	1 1/4"
	SHCLARND1.25 - 8 pack	1 1/4"		SHCLAPYR1.25 - 8 pack	1 1/4"
	SHCLARND1.25 - 12 pack	1 1/4"		SHCLAPYR1.25 - 12 pack	1 1/4"
	SHCLARND1.25 - 18 pack	1 1/4"		SHCLAPYR1.25 - 18 pack	1 1/4"
	SHCLARND1.25 - 24 pack	1 1/4"		SHCLAPYR1.25 - 24 pack	1 1/4"
	SHCLARND1.25 - 100 pack	1 1/4"		SHCLAPYR1.25 - 100 pack	1 1/4"

* Sold in packs of 2.



Parts may be required to ship LTL (less than truckload) based on size and overall dimensions.

Shutter Board Fabrication Panels

(items are approximate scale only)

Shutter Board Fabrication Panels

Rough Sawn Cedar

NON-STOCK
SPECIAL ORDER ITEM

	Individual Sheet Part Number	Width	Length	Thickness	Contractor Pack Part Number
	SHBB12X144RS 2-Board Panel	12"	144"	3/4"	SHBB12X144RS-CP Contractor Packs sold in packs of 10
	SHBB14X144RS 3-Board Panel	14"	144"	3/4"	SHBB14X144RS-CP Contractor Packs sold in packs of 10
	SHBB18X144RS 3-Board Panel	18 "	144"	3/4"	SHBB18X144RS-CP Contractor Packs sold in packs of 10
	SHBB24X144RS 4-Board Panel	24"	144"	3/4"	SHBB24X144RS-CP Contractor Packs sold in packs of 10
	FLT1X4-12RS Batten Trim	3 1/2"	144"	3/4"	—



(items are approximate scale only)

Louvered Shutter / Panel Shutter



Louvered Shutter

Woodgrain with Center Rail

NON-STOCK
SPECIAL ORDER ITEM

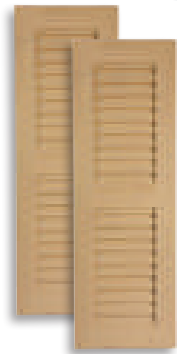

Part Number	Width	Height
LVSH12X36FNCR3S	12"	36"
LVSH12X48FNCR3S	12"	48"
LVSH16X48FNCR3S	16"	48"
LVSH16X60FNCR3S	16"	60"
LVSH18X48FNCR4S	18"	48"
LVSH18X60FNCR4S	18"	60"

NOTE: Sold in pairs.

Panel Shutter

Woodgrain with Border

NON-STOCK
SPECIAL ORDER ITEM

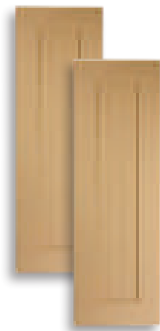

Part Number	Width	Height
SH3PB15X46S	15"	46"
SH3PB18X40S	18"	40"
SH3PB18X66S	18"	66"
SH3PB24X54S	24"	54"

NOTE: Sold in pairs.
Product image is representative of actual part.

Shutter Louvered Fabrication Panels

Woodgrain

NON-STOCK
SPECIAL ORDER ITEM

Part Number	Width	Length	Thickness
LVSSNN32X144S	32"	144"	5/8"

NOTE: Timber louvered panels sold in individual sheets.



Brackets, Corbels & Rafter Tails









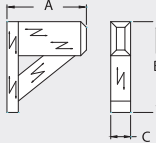

BRACKETS, CORBELS & RAFTER TAILS

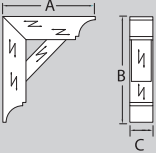

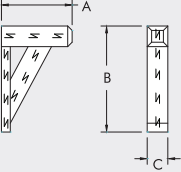
(items are approximate scale only)

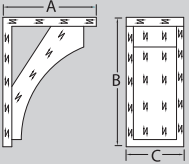
Brackets

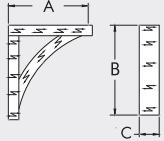

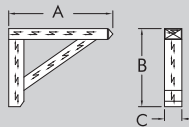
Part Number	Projection (A)	Height (B)	Overall Width (C)	
 BKT14X16X3.5S	14"	16"	3 1/2"	
BKT14X16X6S	14"	16"	5 1/2"	
 BKT22X24X4S-1	22"	24"	3 1/2"	
BKT22X24X6S	22"	24"	5 1/2"	
BKT26X24X4S	26"	24"	3 1/2"	
BKT26X24X6S	26"	24"	5 1/2"	
 BKT12X18X3X1S	12"	18"	3 1/2"	
BKT18X18X3X1S	18"	18"	3 1/2"	
 BKT13X18X8S	13"	18"	8"	
 BKT16X18X4S	16"	18"	4"	
 BKT24X18X4S	24"	18"	4"	

NOTE: Brackets are listed in order by height.









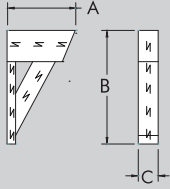

Brackets

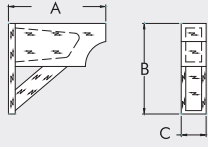
(items are approximate scale only)

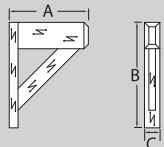
Brackets

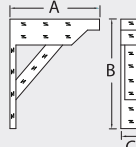
Standard Woodgrain
Continued

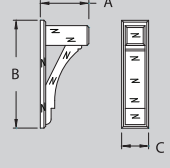
NON-STOCK
SPECIAL ORDER ITEM

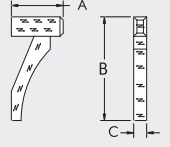
Part Number	Projection (A)	Height (B)	Overall Width (C)	
 BKT12X20X3S	12"	20"	3 1/2"	
 BKT18X20X3S	18"	20"	3 1/2"	
 BKT21X20X6S	21 1/2"	20"	5 1/2"	
 BKT18X24X3X2S	18"	24"	3 1/2"	
 BKT22.5X27.5X5.5S	22 1/2"	27 1/2"	5 1/2"	
 BKT14X30X7.5S	13 1/2"	30"	7 1/2"	
 BKT22X30X8S	21 1/2"	30"	7 1/2"	
 BKT16X32X4S	16"	32"	4"	







(items are approximate scale only)

Knee Braces

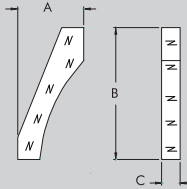

Knee Braces

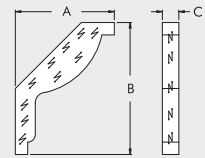
Standard Woodgrain

Part Number	Projection (A)	Height (B)	Overall Width (C)	
BKT12X24X3S	12"	24"	3 3/8"	
 BKT12X24X3S	12"	24"	3 3/8"	
BKTCV18X24X4S	18"	24"	3 1/4"	
BKTCV18X24X6S	18"	24"	5 1/4"	
BKTCV21X30X4S	21"	30"	3 1/4"	
BKTCV21X30X6S	21"	30"	5 1/4"	
 BKTSC18X24X3S <small>NON-STOCK SPECIAL ORDER ITEM</small>	18"	24"	3"	
 BKTS18X24X6S	18"	24"	5 1/2"	
 BKT22X30X6S <small>NON-STOCK SPECIAL ORDER ITEM</small>	21 1/2"	30"	6"	

Parts may be required to ship LTL (less than truckload) based on size and overall dimensions.







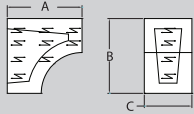

Corbels - Cove

(items are approximate scale only)

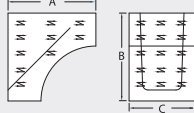
Corbels - Cove

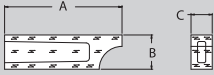
Standard Woodgrain

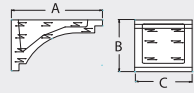
	Part Number	Projection (A)	Height (B)	Overall Width (C)	
 <p>NON-STOCK SPECIAL ORDER ITEM</p>	COR5X5X3S*	5 1/2"	5 1/2"	3 1/2"	
	COR5X5S*	5 1/2"	5 1/2"	5 1/2"	
	COR8X8X6S*	8"	8"	6"	
	COR11X11X5S*	11"	11"	5"	
	CORCV18X6X6S*	18"	5 1/4"	5 1/4"	
	CORCV18X8X4S*	18"	7 1/4"	3 1/4"	
	CORCV18X8X6S*	18"	7 1/4"	5 1/4"	
	CORCV18X12X6S*	18"	11 1/4"	5 1/4"	
	COR24X8X6S*	24"	8"	6"	
 <p>NON-STOCK SPECIAL ORDER ITEM</p>	COR7X13X7S*	13"	7 1/4"	7 1/2"	

*Product has open cavity.



Parts may be required to ship LTL (less than truckload) based on size and overall dimensions.













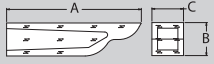

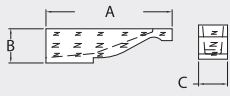

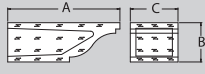

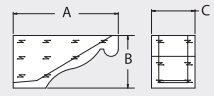

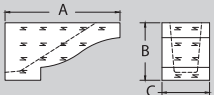
Corbels - Scroll

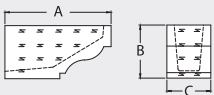
(items are approximate scale only)

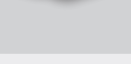
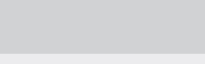
Corbels - Scroll

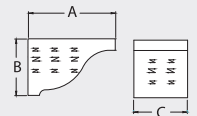
Standard Woodgrain

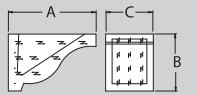
	Part Number	Projection (A)	Height (B)	Overall Width (C)	
	COROG24X6S*	24"	5 7/8"	5 5/8"	
 <small>NON-STOCK SPECIAL ORDER ITEM</small>	COR24X6X5S*	24"	6 1/2"	5 1/2"	
	COROG20X7S*	20"	7"	8 1/2"	
 <small>NON-STOCK SPECIAL ORDER ITEM</small>	COROG15X7S*	14 1/2"	7 1/4"	6"	
 <small>NON-STOCK SPECIAL ORDER ITEM</small>	COROGA15X7S*	14 1/2"	7 1/4"	6"	
 <small>NON-STOCK SPECIAL ORDER ITEM</small>	COROGD15X7S*	14 1/2"	7 1/4"	6"	
	COROG29X8S*	28 3/8"	7 3/8"	7 3/8"	
 <small>NON-STOCK SPECIAL ORDER ITEM</small>	COROG48X8S*	48"	7 3/8"	7 3/8"	
 <small>NON-STOCK SPECIAL ORDER ITEM</small>	COR7X11S	11 3/8"	7 3/8"	7"	
	COROG8X12S*	11 3/8"	7 3/8"	7 3/8"	

*Product has open cavity.



(items are approximate scale only)

Corbels - Scroll



Corbels - Scroll

Standard Woodgrain
Continued

NON-STOCK
SPECIAL ORDER ITEM

Part Number	Projection (A)	Height (B)	Overall Width (C)
 COR39X10X5.5S*	39 1/4"	9 1/8"	5 1/2"
 COR16X10X8S*	16"	10 1/2"	8"
 COR12X12X4-7S*	12"	12"	4"
 COR14X12X6S*	14"	12"	6"
 COR11X13X6S*	11"	13"	6"

*Product has open cavity.











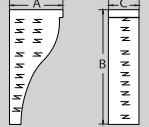

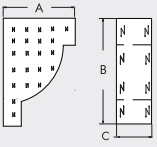
Corbels - Assorted

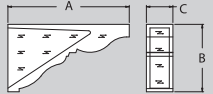
(items are approximate scale only)

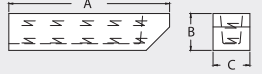
Corbels - Assorted

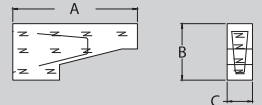
Standard Woodgrain

Part Number	Projection (A)	Height (B)	Overall Width (C)	
 <p>COR7X15X4S NON-STOCK SPECIAL ORDER ITEM</p>	7"	15"	4"	
 <p>COR12X18X6S NON-STOCK SPECIAL ORDER ITEM</p>	12"	18"	6"	
 <p>COROG34X19S*</p>	33 3/4"	18 3/4"	7 3/8"	
 <p>COR24X5X5S* NON-STOCK SPECIAL ORDER ITEM</p>	24"	5 1/2"	5 1/2"	
 <p>COR16X7X3S* NON-STOCK SPECIAL ORDER ITEM</p>	16"	7 1/4"	3 1/4"	
 <p>COR16X7X5S* NON-STOCK SPECIAL ORDER ITEM</p>	16"	7 1/4"	5 1/2"	

*Product has open cavity.



(items are approximate scale only)







Corbels - Assorted

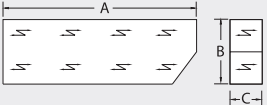

Corbels - Assorted

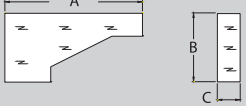
Standard Woodgrain
Continued

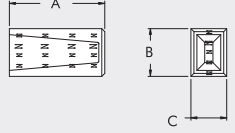
NON-STOCK
SPECIAL ORDER ITEM

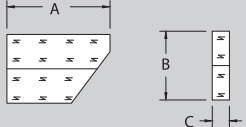
	Part Number	Projection (A)	Height (B)	Overall Width (C)	
	COR24X8X4S	24"	8"	4"	
	COR18X9X3S	18"	9"	3"	
	COR16X8S*	16"	8"	6"	
	COR24X16X4S	24"	16"	4"	

*Product has open cavity.







Rafter Tails

(items are approximate scale only)

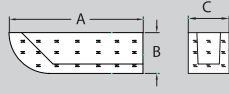
Rafter Tails

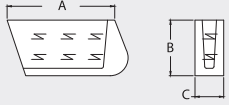
Standard Woodgrain

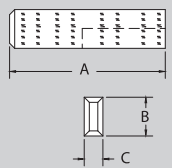
	Part Number	Length	Height	Overall Width	
	BMRTS4X4X24S*	24"	3 1/4"	3 1/4"	
	BMRTS6X4X24S*	24"	5 1/4"	3 1/4"	
	BMRTS6X6X24S*	24"	5 1/4"	5 1/4"	
	BMRTS8X4X24S*	24"	7 1/4"	3 1/4"	
	BMRTS8X6X24S*	24"	7 1/4"	5 1/4"	
	BMRTBN8X4X30S*	30"	7 3/4"	4"	
NON-STOCK SPECIAL ORDER ITEM					
	BMCRT25X12X6S*	25"	12"	6"	
NON-STOCK SPECIAL ORDER ITEM					

*Product has open cavity.



(items are approximate scale only)

Rafter Tails



Rafter Tails

Standard Woodgrain
Double-Ended

NON-STOCK
SPECIAL ORDER ITEM

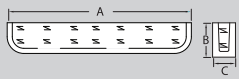
	Part Number	Length	Height	Overall Width	
	BMRTDE6X4X36S*	36"	6"	4"	

*Product has open cavity.



Window & Door Trim

WINDOW & DOOR TRIM



(items are approximate scale only)

Crossheads - Classic

5.5" Crossheads - Classic

Smooth Cedar

NON-STOCK
SPECIAL ORDER ITEM

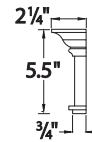
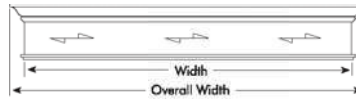

Part Number	Width	Overall Width
CHAC33X5.5S	33"	36"
CHAC39X5.5S	39"	42"
CHAC72X5.5S	72"	75"

7.5" Crossheads - Classic

Smooth Cedar

NON-STOCK
SPECIAL ORDER ITEM

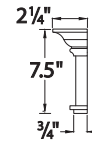
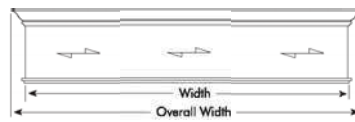

Part Number	Width	Overall Width
CHAC33X7.5S	33"	36"
CHAC39X7.5S	39"	42"
CHAC72X7.5S	72"	75"

9.5" Crossheads - Classic

Smooth Cedar

NON-STOCK
SPECIAL ORDER ITEM

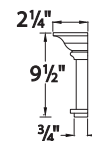
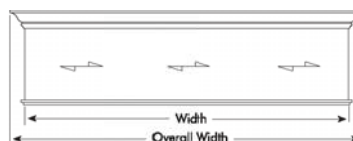

Part Number	Width	Overall Width
CHAC33X9.5S	33"	36"
CHAC39X9.5S	39"	42"
CHAC72X9.5S	72"	75"

Parts may be required to ship LTL (less than truckload) based on size and overall dimensions.





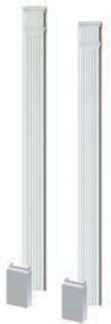

Polyurethane Pilasters / Corbels / Louvers

(items are approximate scale only)

Pilasters	Part Number	Width	Height	Plinth Height
	PIL6X108 2-Piece Adjustable Fluted Pilaster w/Plinth <i>(sold in sets only)</i>	6-1/4"	108"	13-1/4"
	PIL8108 2-Piece Adjustable Fluted Pilaster w/Plinth <i>(sold in sets only)</i>	8"	108"	13"

Corbel	Part Number	Width	Height	Projection
	COR5X10 Recessed Decorative Corbel	4"	10"	5-1/4"

Functional Louvers	Part Number	Width	Height	Outside Diameter	Trim Width	Trim Thickness	Vent Area
	FLV16X24 Functional Vertical Smooth Louver	16"	24"				21 sq. in.
	FRLV16 Functional Round Smooth Louver			16"			
	FRLV18 Functional Round Smooth Louver			18"			
	FRLV22 Functional Round Smooth Louver			22"			
	FRLV24 Functional Round Smooth Louver			24"			
	FRLV24TK Round Smooth Louver with Flat Trim and Keystones	24"	24"	22-7/8"	3-1/2"	1"	10 sq. in.

Decorative Louvers	Part Number	Width	Height	Outside Diameter	Trim Width	Trim Thickness	Vent Area
	RLV18 Decorative Round Smooth Louver			18"			

(items are approximate scale only)

Polyurethane Crown

Crown	Part Number	Projection	Height	Length	Bottom Thickness	Tooth	Pattern Repeats
	MLD405-12 Florentine Dentil Crown	3-5/8"	5-3/4"	12'-6"	5/8"	5/8"	12-1/2"
	MLD410-12 Roman Dentil Crown	3-1/4"	6-7/8"	12'	1/2"	1-1/2"	3"
	MLD425-12 Tuscan Dentil Crown w/Swag	4-1/8"	9-1/2"	11'5"	3/4"	5/8"	13-1/2"
	MLD432-12 Classic Dentil Crown	4"	4-1/2"	12'-3"	1/4"	1/2"	1"
	MLD460-12 Classic Crown	4-3/8"	5-1/8"	12'	3/4"		
	MLD490-12 Florentine Crown	6"	5-1/2"	11'-5"	1/4"		13"
	MLD493-12 Greek Acanthus Leaf Crown	5-1/2"	6-5/8"	12'	3/8"		4"
	MLD495-16 Leaf Crown	5-3/8"	10-1/8"	16'	5/8"		7-3/4"
	MLD560-8 Egg & Dart Crown	5-3/4"	9-1/8"	8'	1-3/8"		5-1/4"
	MLD564-16 Egg & Dart Crown	2-5/8"	5-7/8"	16'	1/4"		2-3/4"
	MLD732-12 Classic Egg & Dart w/Acanthus Leaf Crown	4-3/4"	7-1/4"	12'	5/8"		5-3/8"

Polyurethane Ceiling Medallions

(items are approximate scale only)

Ceiling Medallions	Part Number	Width	Height	Outside Diameter	Inside Diameter	Projection
	CM36NI Nicolas Ceiling Medallion with 2" Hole			35-3/4"	2"	2"
	CM38SY Symmetria Ceiling Medallion with 1" Hole	38-1/8"	28-5/8"		1"	1-3/4"
	CM67WT Whitney Ceiling Medallion with 4-3/8" Hole	67-1/2"	43-1/2"		4-3/8"	1"
	CM74SF Suffolk Ceiling Medallion			74-1/4"		2"
	CM15BM Beaumont Ceiling Medallion with 1" Hole			14-3/8"	1"	2-1/4"
	CM16FL Florentine Ceiling Medallion with 4-1/8" Hole			16"	4-1/8"	1-1/8"

(items are approximate scale only)

Polyurethane Ceiling Medallions

Ceiling Medallions	Part Number	Width	Height	Outside Diameter	Inside Diameter	Projection
	CM16FL2 Split Florentine Ceiling Medallion with 5-5/8" Hole			15-3/4"	5-5/8"	1-5/8"
	CM16JE2 Split Jefferson Ceiling Medallion with 5-3/4" Hole			15-1/2"	5-3/4"	3/4"
	CM24RN Randolph Ceiling Medallion with 1" Hole			24-3/8"	1"	1-1/2"
	CM30AL Acanthus Leaf Ceiling Medallion with 1" Hole			30-1/4"	1"	2-1/2"
	CM32R02 Split Rochelle Ceiling Medallion with 5-3/4" Hole			31-7/8"	5-3/4"	2-1/4"
	CM32SG St. George Ceiling Medallion with 1" Hole			32-1/2"	1"	2-1/2"



Big Ideas

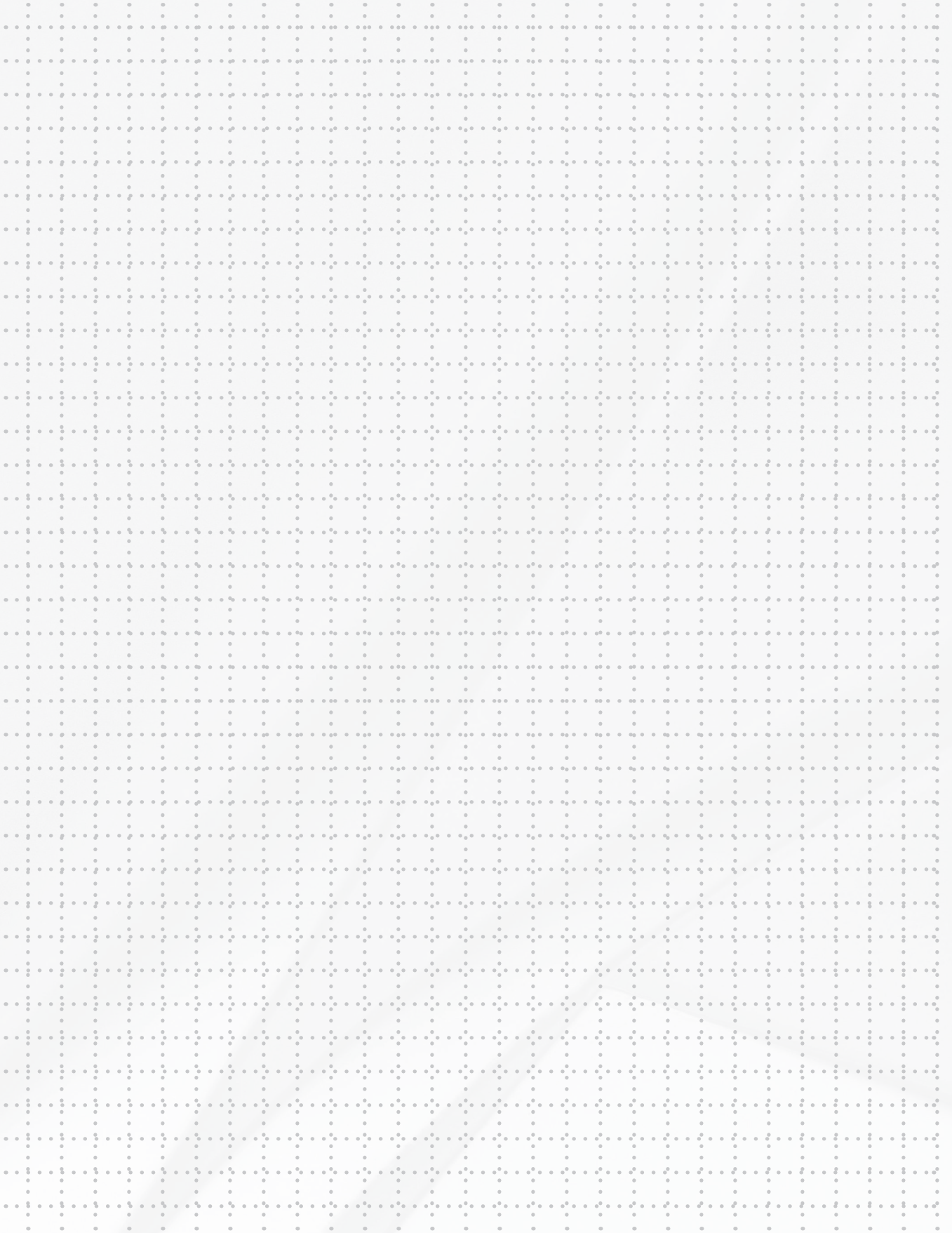

Protected Exterior Bodyguard® Sidings, S1S2E Trimboards & Exterior Mouldings



ECOLOGICAL AND DURABLE STRUCTURAL PROTECTION



CALIFORNIA FIRE APPROVAL

Bodyguard® has had profiles successfully tested by Western Fire Center Inc., to California State Fire Marshall Regulations.

SIDINGS

Tested in accordance with California State Fire Marshall Regulation 12.7A-1. This approval is for horizontal applications only and requires installation over OSB with a minimum thickness of 7/16".

UNDER EAVES

Tested in accordance with California State Fire Marshall 12.7A-3. This approval is for beaded T&G product (#801BG & #802BG) and must be mounted over a minimum of 1/2" exterior grade gypsum board.

Until now, it's been hard for contractors and homeowners to find genuine wood building solutions they can trust to last, and that look great. Bodyguard® is the original producer of treated FJ Pine products from New Zealand. Protected by an environmentally friendly preservative, Bodyguard® products provide long-lasting life and protection against decay, corrosion and insects. Sourced from the clean, green sustainable pine forests of New Zealand, these products are environmentally safe, easy to use and come with a 30-year warranty.

Sold exclusively through EL & EL Wood Products.

section contents

Bodyguard® Exterior Primed Millwork.....	97
Bodyguard® Interior / Exterior T&G.....	96
Bodyguard® Fire Rated Primed FJ Siding...	94
Bodyguard® Protected Siding	93
Bodyguard® Protected Trimboards	93
Pakari Trimboards.....	100



Bodyguard® Primed FJ Pine

I/E

DESIGN STYLES

TRADITIONAL | CONTEMPORARY | COASTAL

**JANKA
HARDNESS**
(POUNDS-FORCE)

N/A



Natural Wood Solutions For Today's Building Challenges!



SUSTAINABLE - Bodyguard® wood products come from the well-managed pine plantation forests in clean, green New Zealand.



PROTECTED - The unique pressure treatment achieves total "active penetration" protection of the wood. The addition of waxes and resins boosts its water protection properties. The active ingredients used in this treatment process (known as Light Organic Solvent-borne Preservatives (LOSP's) do not dissolve in water and will not be removed through leaching.



ENVIRONMENTALLY FRIENDLY AND SAFE - The Bodyguard® preservative system is based on carbon based biocides and is registered in the United States of America by the EPA. As Bodyguard® is real wood and contains no hazardous additives it is safe to work with, just follow normal workplace safety practices for handling wood products.



DEFECT FREE - Bodyguard® is a natural wood product manufactured from kiln-dried timber. All defects, such as knots and resin pockets, are removed prior to fingerjointing.



TERMITE RESISTANT - One of the active protective ingredients in Bodyguard® is Permethrin, a food-crop protection product effective against all known species of termite.



FSC CERTIFIED - By buying products with an FSC label you are helping to promote responsible forest management worldwide. Ask for our supply availability of FSC certified products. (SCS-COC-00538 / SCS-COC-004440 / SGS-COC-003178 / RA-COC-005483).



GREEN BUILDING CREDITS - Bodyguard® qualifies for credit points under the following schemes:

- LEED for Homes
- NAHB Model Green Home Building Guidelines
- GreenPoint Rated (California only)



PAINT-READY FINISH - The machined finish of Bodyguard® is enhanced by a two-coat alkyd primer system and comes with a performance warranty. A good-quality acrylic paint system to the manufacturer's specifications will finish the appearance and protection of Bodyguard® perfectly.



SUITABLE FOR USE INSIDE AND OUTSIDE - Bodyguard® is safe for interior and exterior above ground use. We recommend application of finishing coats as soon as practicable after installation. Make sure your Bodyguard® product is dry before painting.



NON-CORROSIVE - The protection system's (LOSP's) do not contain any corrosive heavy metals and will not cause corrosion to nails and other fastening systems. Durable fasteners are recommended as good building practice for exterior applications.



EASE OF USE - No special tools, cutting equipment or fixing methods are required with Bodyguard®.



30 YEAR WARRANTY - A 30-year limited warranty is provided on all Bodyguard® products against termite attack, rot or fungal decay.

PAINTING & INSTALLATION

BODYGUARD® IS PRE-PRIMED (DOUBLE COATED) AND THE FOLLOWING IS RECOMMENDED:

- ❖ Bodyguard products must be painted as soon as practicable after installation.
- ❖ Bodyguard products must be dry before commencing painting (a moisture content of 14% or less).
- ❖ Apply top coat in warm, dry weather not below 50° F.
- ❖ Painting with solid acrylic stains is not recommended as UV light will penetrate the transparent stain and damage the primer paint.
- ❖ We recommend application of the first top coat prior to installation.

1. Nail holes: if nails are countersunk, seal exposed wood with Bodyguard End Seal then fill nail holes with an exterior grade wood filler, then spot prime. In temperatures less than 40°F use cold weather caulking sealants.
2. Remove all soft and chalky paint, dirt, and sand etc. to a smooth even finish.
3. Apply two full coats of premium quality exterior acrylic house paint as per manufacturer's instructions. For best results allow 24hrs between coats.
4. The use of colors with a Light Reflectance Value (LRV) of 45 or more is recommended, as these lighter colors reflect significantly more heat.
5. When cutting or re-machining; brush or spray-on a preservative containing zinc naphthen, Bodyguard End Seal is recommended.
6. **Corrosion resistant fasteners such as hot dipped galvanized nails or stainless steel nails must be used when installing.**
7. All nails should be countersunk and puttied prior to paint.

NOTE: ALL WOOD EXPANDS AND CONTRACTS. It is important to leave 1/8" gap between each piece of siding to allow for expansion. Failure to do so will void warranty and may cause serious issues.



(items are approximate scale only)

Bodyguard® FJ Pine Treated & Protected Siding/ S1S2E Trimboards & Exterior Mouldings



S1S2E TRIMBOARDS

For interior and exterior use. Reversible; rough-sawn on one side, smooth on the other with eased edges. Bodyguard® is manufactured with superior quality and performance in mind.

The result is a product that maintains its appearance and integrity as a uniform and quality building solution. The Bodyguard® product range consists of trimboards, sidings and exterior mouldings in a wide range of profiles and choices.

For homeowners and contractors who prefer the naturalness of wood; who value a durable solution; and who appreciate the confidence shown through a warranty and position. Bodyguard® provides a real wood solution for today's building challenges.



PLEASE REFER TO INSTALLATION AND PAINTING GUIDELINES.

PROTECTED TRIMBOARDS: S1S

Protected S1S2E Trimboards Interior/Exterior Primed FJ Pine			
ITEM	BODYGUARD PART #	SIZE	LENGTHS
1X2S1S	710	3/4 x 1-1/2"	16'
1X3S1S	711	3/4 x 2-1/2"	16' & 20'
1X4S1S	712	3/4 x 3-1/2"	16' & 20'
1X6S1S	714	3/4 x 5-1/2"	16' & 20'
1X8S1S	716	3/4 x 7-1/4"	16' & 20'
1X10S1S	718	3/4 x 9-1/4"	16' & 20'
1X12S1S	720	3/4 x 11-1/4"	16' & 20'
5/4X4S1S	723	1" x 3-1/2"	16' & 20'
5/4X6S1S	724	1" x 5-1/2"	16' & 20'
5/4X8S1S	725	1" x 7-1/4"	16' & 20'
2X2S1S	722	1-1/2 x 1-1/2"	16' & 20'
2X4S1S	713	1-1/2 x 3-1/2"	16' & 20'
2X6S1S	715	1-1/2 x 5-1/2"	16' & 20'
2X8S1S	717	1-1/2 x 7-1/4"	16' & 20'
2X10S1S	719	1-1/2 x 9-1/4"	16' & 20'
2X12S1S	721	1-1/2 x 11-1/4"	16' & 20'

- ✓ Reversible S1S
- ✓ 1side Rough Sewn
- ✓ 1side Smooth
- ✓ 30 Year Limited Warranty

Bodyguard® Fire Rated Primed FJ Siding

lengths available: all 16' & 20' only with 1/2" overlap

(items are approximate scale only)
CALIFORNIA FIRE APPROVAL



371 1 1/16 x 5-1/2 **Rab't Smooth Face Siding** N/S | **372** 1 1/16 x 7-1/2 **Rab't Smooth Face Siding** N/S



430 3/4 x 5-1/2 **2 Lap Siding** N/S



774 3/4 x 7-1/2 **Bevel Channel Siding** N/S | **773** 3/4 x 9-1/2 **Bevel Channel Siding** N/S



432 3/4 x 7-1/2 **3 Lap Siding** N/S | **433** 3/4 x 9-1/2 **3 Lap Siding** N/S

(items are approximate scale only)
CALIFORNIA FIRE APPROVAL

Bodyguard® Fire Rated Primed FJ Siding

lengths available: all 16' & 20' only with 1/2" overlap



793 3/4 x 5-1/2 **V-Rustic Siding** N/S
794 3/4 x 7-1/2 **V-Rustic Siding** N/S

795 3/4 x 9-1/2 **V-Rustic Siding** N/S



771 3/4 x 7-1/2 **Cove Siding** N/S

772 3/4 x 9-1/2 **Cove Siding** N/S

COMING SOON
in early 2018!



1x4BS 1/2 x 4 **#400 Bevel Siding** N/S



1x6NGS 1x6 **Nickel Gap Siding** N/S



Bodyguard® Interior / Exterior T&G

(items are approximate scale only)

✦ lengths available: all 16'

Protected T&G Bead Boards For Interior and Exterior Use

Smooth Surface, Four Sides. Available in 16' lengths. Reversible: Flat or Beaded

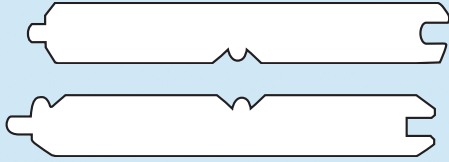

801BG 5/8 x 4 T&G Beaded Wainscot *N/S*
(Exposed face is 3-1/8) *[reversible]*



802BG 1 x 6 T&G Beaded Wainscot *N/S*
(Exposed face is 5-1/8) *[reversible]*

Bodyguard® Exterior Primed & Protected Millwork

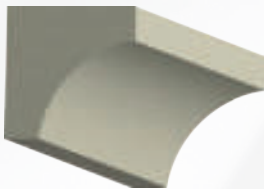

606 11/16 x 11/16 x 16'
Cove *N/S*



614 11/16 x 11/16 x 16'
Quarter Round *N/S*



604 1-7/16 x 1-7/16 x 16'
Outside Corner Guard *N/S*

Bodyguard® Testing & Approvals

CALIFORNIA FIRE APPROVAL

Bodyguard has had profiles successfully tested by Western Fire Center Inc., to California State Fire Marshall Regulations.

Sidings: Tested in accordance with California State Fire Marshall Regulation 12.7A-1. This approval is for horizontal applications only and requires installation over OSB with a minimum thickness of 7/16".

Under Eaves: Tested in accordance with California State Fire Marshall Regulation 12.7A-3. This approval is for beaded T&G product (#801BG & #802BG) and must be mounted over a minimum of 1/2" exterior grade gypsum board.

Bodyguard® FJ Pine Exterior Primed & Protected Millwork

(items are approximate scale only)



224 9/16 x 3/4 x 16' **Base Cap** N/S

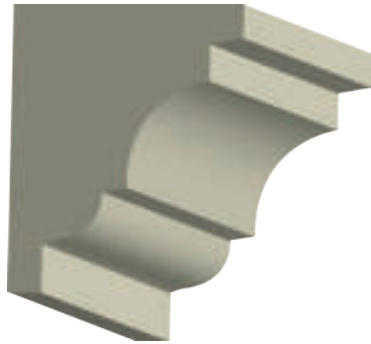

607 1-1/4 x 1-1/2 x 16' **Pediment Crown** N/S

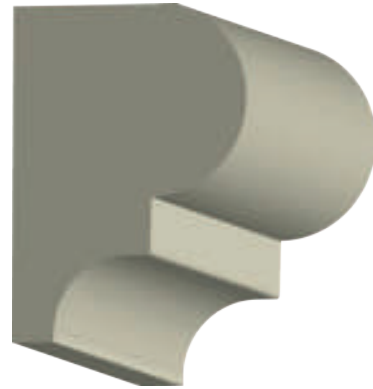

024 1-1/4 x 1-3/4 x 17' **Bead & Nose Coving** N/S



387 1-1/16 x 3-1/4 x 17' **Howe Casing** N/S



388 11/16 x 3-1/4 x 17' **Carolina Casing** N/S



1400 1-3/16 x 4-1/4 x 17' **Architrave** N/S



616 11/16 x 1-5/8 **Shingle Mold** N/S

✦ lengths available: 16'



629 1 x 2-5/8 **Stucco Mold** N/S

✦ lengths available: 17'



Bodyguard® Exterior Primed & Protected Millwork

(items are approximate scale only)

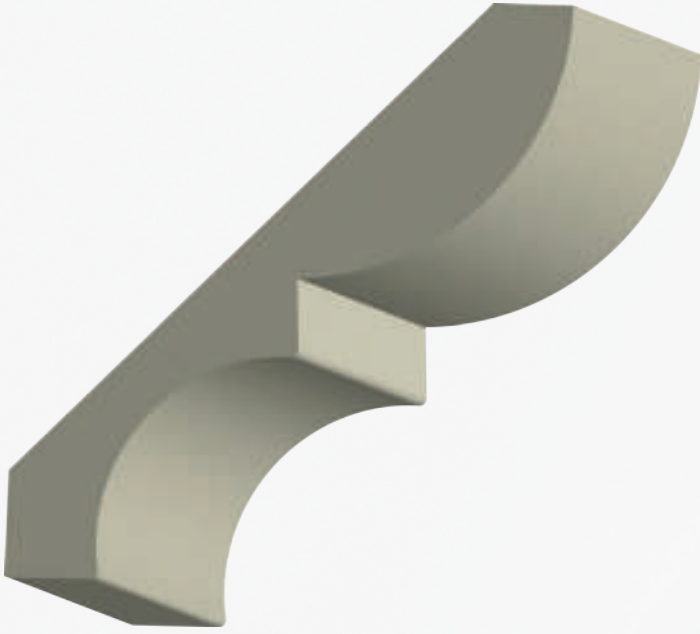

639 3/4 x 4-5/16 x 16' **Bed & Cove** N/S

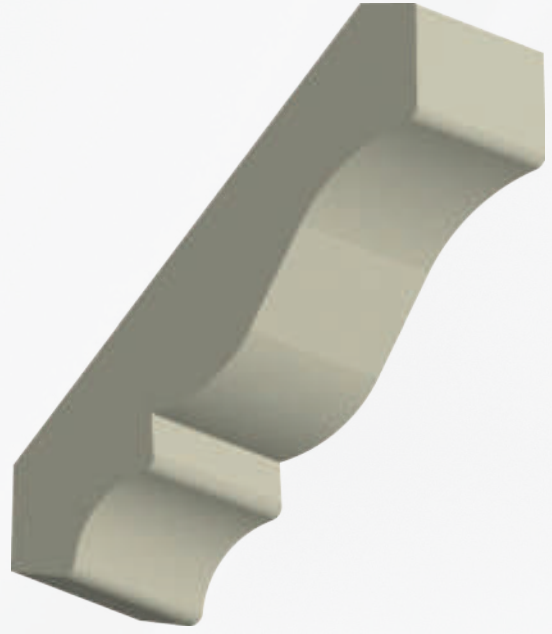

286 5/8 x 3-5/8 x 16' **Colonial Crown** N/S

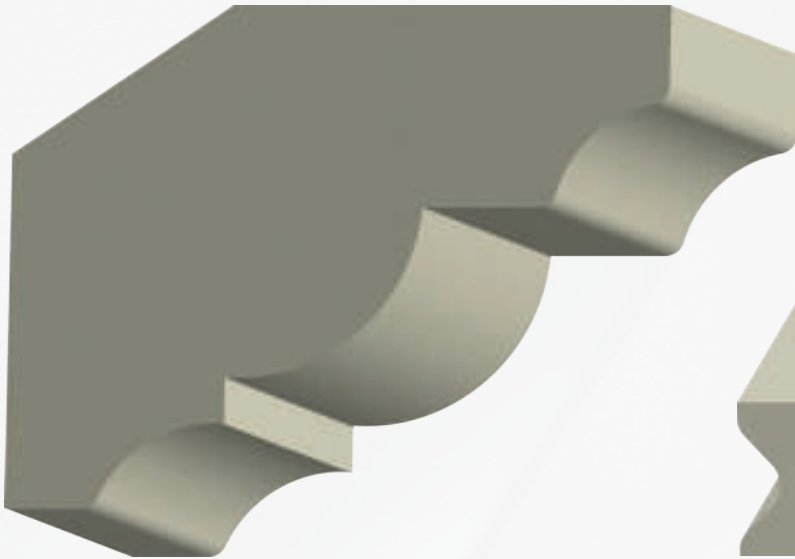

638 1-3/8 x 3-5/16 x 16' **Gutter Mould** N/S

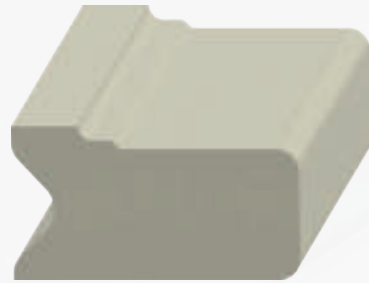

618 13/16 x 1-1/2' **Stucco Mold** N/S
lengths available: 17'

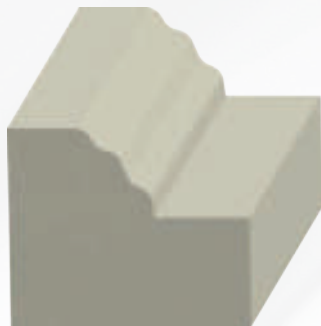

619 1-1/4 x 1-1/2 x 16' **Brick Mold** N/S
lengths available: 16'



627 15/16 x 1-15/16' **Step Stucco Mold** N/S
lengths available: 17'



Bodyguard® Exterior Primed & Protected Millwork

(items are approximate scale only)



381 1-1/4 x 2 #180 Eastern Brick Mold without Stucco Key *N/S*
lengths available: 17'



381K 1-1/4 x 2 #180 Eastern Brick Mold w/Stucco Key *N/S*
lengths available: 17'



630 1-7/16 x 2-1/16 **Watertable** *N/S*
lengths available: 16' only



634 1-7/16 x 3-1/4 **Watertable** *N/S*
lengths available: 16' only



642 1-3/8 x 7 **Detailed Sill** *N/S*
lengths available: 16'

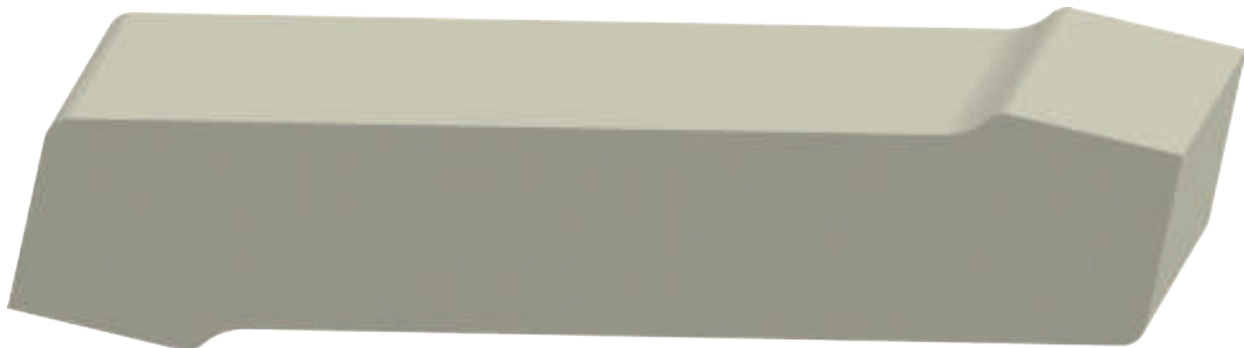

640 1-3/8 x 7 **Protected Reversible Sill** *N/S*
lengths available: 16'

Pakari Interior/Exterior Trimboards



(items are approximate scale only)

✦ lengths available: 8' thru 16'

Introducing...Pakari,
a thermally modified Pine
wood that is chemical
free using a simple heat
treatment of steam and
high temperatures.



- ✓ FSC Certified
- ✓ Chemical Free Modification
- ✓ Insect & Rot Resistant
- ✓ Natural Rustic Appearance
- ✓ Lightweight
- ✓ Long Lengths
- ✓ Renewable Resource

Once the pine wood has been put through the unique process of Thermal Modification it is improved at the molecular level, taking on an abundance of new benefits; increased durability, stability, and even a reduction in the weight of the wood. The Pine wood turns into a rich chocolate brown color that is normally only seen in exotic hardwoods. If left untreated under direct sunlight, Pakari will eventually weather to a natural silver patina. To keep Pakari at its original chocolate brown color, it is recommended to use a UV protective coating.

Pakari's long length structure and lighter weight add up to a lower installation cost while providing an exotic look with a variety of design options.

Pakari is versatile enough to use indoor or outdoor. If used for an outdoor application, we recommend all Thermally Modified products be installed at least 12" above the ground and for siding application, using proper gap and nailing procedures to allow for normal wood expansion.



PAK1x4BW 11/16 x 3-5/8 **Pakari Rustic Barnwood Lumber** N/S



PAK1x6BW 11/16 x 5-3/4 **Pakari Rustic Barnwood Lumber** N/S



PAK1x6LAP 11/16 x 5-7/16 **Pakari Lap-Joint Paneling** N/S



DECKING SIDING TRIM INTERIOR DESIGN & DECOR



Solid Pine



BEAUTIFULLY GRAINED AND EASY TO WORK WITH



Solid Pine is beautifully grained, easy to work with and offers many choices for finishing. Pine can simply be clear coated to show its natural warmth, or it can be stained in a variety of colors, antiqued, or painted. Solid Pine often has a special place in the hearts of those who love wood.

When staining pine it is recommended to use a highly trained professional, as pine is a softwood that can absorb stain differently across the wood creating a blotchy look.



section contents

Astragal.....	118
Base	107
Base Shoe & Cap	107
Casing.....	101
Chair Rail.....	117
Cove	116
Crown.....	112
Exterior Molds	121
Full Round	121
Half Round	116
Interior Door Jambs	124
Lattice	121
Outside Corner Guard.....	120
Panel Cap.....	118
Panel & Decorative Mold.....	119
Quarter Round	116
S4S.....	121
Standard Door Frame	124
T&G Wainscot.....	122
Weatherstrip Kerfed Eext. Door Frames	124
Window & Door Stop.....	106
Window Stool.....	122

guide

SPECIES

Solid Pine

DESIGN STYLES

TRADITIONAL | RUSTIC

INTERIOR/EXTERIOR

I/*E

JANKA
HARDNESS
(POUNDS-FORCE)

380

CUT LIST

Determining How Much You Need

- 1 Measure the room at the height or length where each moulding goes to determine the number and the length of the pieces you'll need.
- 2 Solid pine moulding is available in 8-16 ft. lengths. Add your footage and multiply that number by 1.1. The result is the total footage needed plus ten percent for waste. Perform this step for each type of moulding, base, chair rail and crown, separately.
- 3 When ordering casing for 6/8 doors, order 7' or 8' lengths and for 8/0 doors use 9' or 10' lengths.
- 4 Most door heads are cut from lineal random lengths. Always cut the longest pieces first.
- 5 The most important tool when working with moulding is **patience**. Remember the old adage, measure twice and cut once. Never try to rush trim work.
- 6 Lengths ordered may not always be available. Always verify availability when ordering.

ALWAYS TEST TO MAKE SURE YOUR MEASURING TOOLS ARE ACCURATE. IF YOU ARE WORKING WITH A HELPER, TAKE A MEASUREMENT WITH ONE TOOL WHILE YOUR HELPER MEASURES WITH ANOTHER AND COMPARE YOUR RESULTS.

HELPFUL HINTS

- * **Chair rails** can be installed 32" to 36" from the floor.
- * Base, shoe and quarter rounds should be the **last mouldings to be installed**.
- * Use Rosettes and Plinth blocks at the corners of windows and doors to **eliminate the mitering process**.
- * Use any brand of spray furniture polish on saw blade as a **lubricant for easier cutting**.
- * **After installation is complete:** caulk and/or putty all gaps and nail holes with wood putty.
- * **CHECK the moisture content of all wood moulding:** for interior trim, the MC should be 8-10%; for exterior trim the MC should be 12-14%. For every 4% change in MC, wood moves 1%.

FINISHING

1 Sand the surface of the pine moulding until it is smooth. Finish it with at least a 220 grit sandpaper for best results. Remove dust with a tack rag or by blowing the moulding clean with compressed air.

2 Apply a thin coat of the prepared shellac to the moulding using a clean cloth. Allow the shellac to dry. Sand lightly with 320 grit sandpaper to smooth the surface; don't remove the shellac layer. Remove dust from the surface before applying stain or another coat. Each coat of shellac will decrease the amount of stain that can penetrate the wood.

3 Pour 1 cup of shellac into a quart container. Add three cups of denatured alcohol. Stir well. Place a lid on the container until you are ready to use the thinned shellac.

4 Apply stain with a clean cloth. Stir the container of stain frequently as you work to maintain consistent color. Leave the stain on for the desired amount of time, then wipe thoroughly with a clean cloth. Sand lightly between coats of stain and before applying a protective clear coat.



SOLID PINE CAN ABSORB STAIN UNEVENLY. ALWAYS APPLY A LIBERAL COAT OF A PRE-STAIN WOOD CONDITIONER PRIOR TO STAINING AND, EVEN THEN, SELECT LIGHT TO MEDIUM COLORS FOR STAINING.

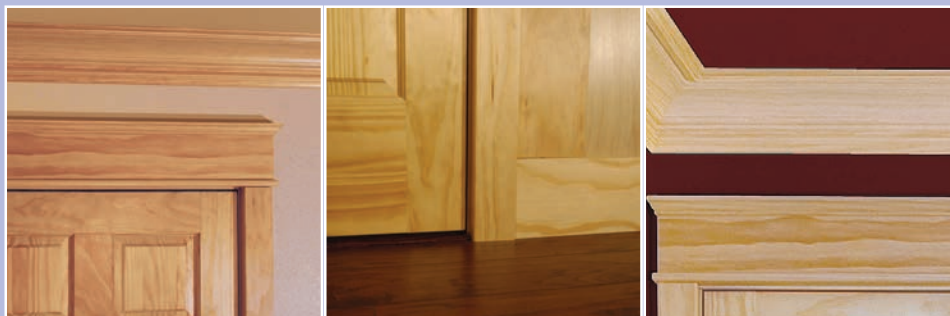

*EXTERIOR ITEMS CAN BE FOUND ON P.121 and 124



1-1/8" to 1-5/8" Casing

lengths available: 7' thru 16'

(arranged in order of width; items are approximate scale only)

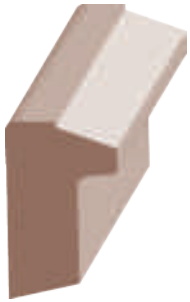

190SP 11/16 x 1-1/8
Solid Pine Back Band S
 (lips 9/16")



104SP 1/2 x 1-1/2
Solid Pine Streamline Casing S



100SP 9/16 x 1-5/8
Solid Pine 2 Round Edge Casing N



101SP 1/2 x 1-5/8
Solid Pine Streamline Casing S



102SP 5/8 x 1-5/8
**Solid Pine Flat Beveled/
 Streamline Casing** N/S



105SP 5/8 x 1-5/8
Solid Pine Oval/Streamline Casing N/S



107SP 5/8 x 1-5/8
Solid Pine #711 Casing S



109SP 5/8 x 1-5/8
Solid Pine 3-Step Casing N/S



111SP 1/2 x 1-5/8
Solid Pine Bead & Barrel Casing S



112SP 1/2 x 1-5/8
Solid Pine 4-Bead Casing S



113SP 1/2 x 1-5/8
Solid Pine #1550 Casing S



130SP 5/8 x 1-5/8
Solid Pine Moulded Casing N



142SP 9/16 x 1-5/8
Solid Pine Oval Casing N



2" to 2-1/4" Casing

lengths available: 7' thru 16'

(arranged in order of width; items are approximate scale only)



121SP 5/8 x 2
Solid Pine Clamshell Casing **S**



103BSP 5/8 x 2-1/4
Solid Pine Beveled Casing **N**

103SP 5/8 x 2-1/2
Solid Pine Streamline Casing **S**



106BSP 5/8 x 2-1/4
Solid Pine Oval Casing **N**

106SP 5/8 x 2-1/2
Solid Pine Streamline Casing **S**



110BSP 5/8 x 2-1/4
Solid Pine 3-Step Casing **N**

110SP 5/8 x 2-1/2
Solid Pine 3-Step Casing **S**



120BSP 9/16 x 2-1/4
Solid Pine 2 Round Edge Casing **N**

120SP 5/8 x 2-1/2
Solid Pine 2 Round Edge Casing **S**



141SP 5/8 x 2-1/4 Solid Pine Moulded Casing **N**



143SP 9/16 x 2-1/4 Solid Pine Oval Casing **N**



152SP 11/16 x 2-1/4 Solid Pine Colonial/#356 Casing **N/S**
Also Available in Pre-packaged Sets

2-1/2" to 2-5/8" Casing

lengths available: 7' thru 16'

(arranged in order of width; items are approximate scale only)



108SP 5/8 x 2-1/2
Solid Pine #711 Casing **S**



115SP 5/8 x 2-1/2
Solid Pine Universal Casing **S**



116SP 11/16 x 2-1/2
Solid Pine Colonial Casing **S**



122SP 5/8 x 2-1/2
Solid Pine 7-Bead Casing **S**



131SP 11/16 x 2-1/2
Solid Pine Riviera Casing **N**



150SP 5/8 x 2-1/2
Solid Pine Cape Cod Casing **N/S**



169SP 11/16 x 2-1/2 Victorian Casing **N**



145SP 5/8 x 2-5/8 Coronado Casing / Chair Rail **N**



2-7/8" to 3-1/4" Casing

✦ lengths available: 8" thru 16"

(arranged in order of width; items are approximate scale only)



119SP 11/16 x 2-7/8
Solid Pine Colonial Casing **S**



139SP 9/16 x 3-1/4
Solid Pine 2 Round Edge Casing **N/S**



155BSP 11/16 x 3-1/4
Solid Pine Cape Cod Casing **N**

155SP 11/16 x 3-1/2
Solid Pine Cape Cod Casing **S**



176SP 5/8 x 3-1/4
Solid Pine Moulded Casing **N/S**

(arranged in order of width; items are approximate scale only)

3-1/4" to 4-1/4" Casing

lengths available: 7' thru 16'



186SP 1 x 3-1/4
Solid Pine 49er Casing N



114SP 1/4 x 3-1/2
Solid Pine 2 Eased Edge Mullion Casing S



117SP 9/16 x 3-1/2
Solid Pine Colonial Casing/Base S
(use with 190SP to create a wider casing)



118SP-4 9/16 x 4-1/4
Solid Pine Colonial Casing/Base S
(use with 190SP to create a wider casing)



Window & Door Stop

lengths available: 7' thru 16'

(arranged in order of width; items are approximate scale only)



200SP 3/8 x 1/2
Solid Pine
1 Round Edge Stop **S**



213SP 3/8 x 3/4
Solid Pine
1 Round Edge Stop **S**



212SP 7/16 x 7/8
Solid Pine
1 Round Edge Stop **N**



204SP 1/2 x 3/4
Solid Pine
1 Round Edge Stop **S**



208SP 3/8 x 1
Solid Pine
1 Round Edge Stop **S**



205SP 1/2 x 1
Solid Pine
1 Round Edge Stop **S**



214SP 7/16 x 1-1/8
Solid Pine
1 Round Edge Stop **N**



201SP 7/16 x 1-1/4
Solid Pine
1 Round Edge Stop **N**



202SP 3/8 x 1-1/4
Solid Pine
1 Round Edge Stop **S**



206SP 1/2 x 1-1/4
Solid Pine
1 Round Edge Stop **S**



210BSP 7/16 x 1-3/8
Solid Pine
Colonial Stop **N**

210SP 1/2 x 1-3/4
Solid Pine
Ogee Stop **S**



216SP 7/16 x 1-3/8
Solid Pine
1 Round Edge Stop **N**



219SP 7/16 x 1-3/8
Solid Pine Ogee Stop **N/S**



203SP 3/8 x 1-5/8
Solid Pine
1 Round Edge Stop **S**



207SP 1/2 x 1-5/8
Solid Pine
1 Round Edge Stop **S**



217SP 7/16 x 1-5/8
Solid Pine
1 Round Edge Stop **N**



218SP 7/16 x 2-1/4
Solid Pine
1 Round Edge Stop **N**

(arranged in order of width; items are approximate scale only)

3/4" to 2-1/4" Base, Shoe & Cap

lengths available: 8' thru 16'

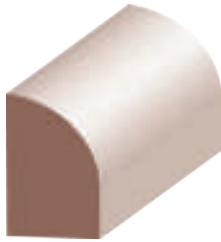

300BSP 1/2 x 3/4
Solid Pine Base Shoe **N/S**



300ASP 3/8 x 3/4
Solid Pine Base Shoe **S**

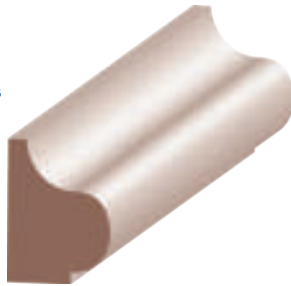

615SP 9/16 x 3/4
Solid Pine Base Cap **N**



614SP 11/16 x 1-3/8
Solid Pine
Coronado Base Cap **N/S**

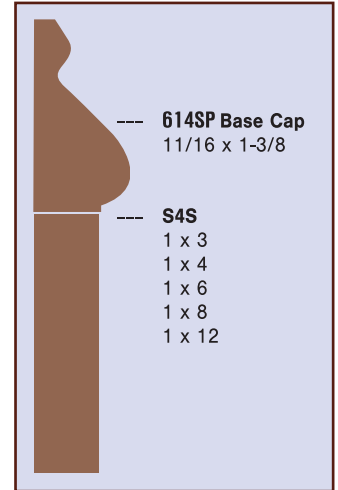

301SP 7/16 x 1-1/2
Solid Pine
Flat Base/Apron **S**

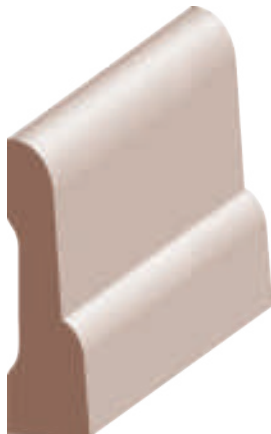

308SP 7/16 x 1-9/16
Solid Pine Combo
Base & Shoe **S**



302SP 7/16 x 1-5/8
Solid Pine
Streamline Base **S**



303SP 1/2 x 1-5/8
Solid Pine
Streamline Base **S**



304SP 3/8 x 2-1/4
Solid Pine
Streamline Base **S**



306BSP 1/2 x 2-1/4
Solid Pine
Streamline Base **N**

306SP 1/2 x 2-1/2
Solid Pine
Streamline Base **S**

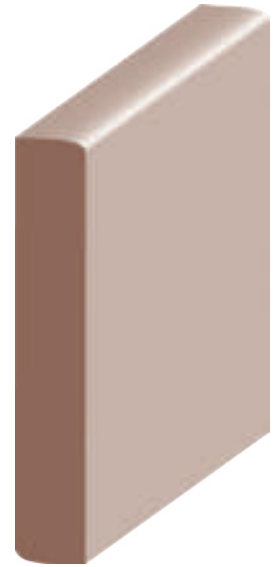

R304SP-2 3/8 x 2-1/4
Reversible Base **N**



2-1/4" to 2-1/2" Base

lengths available: 8' thru 16'

(arranged in order of width; items are approximate scale only)

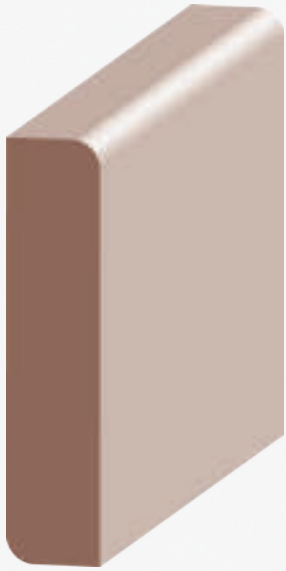

R306SP-2 1/2 x 2-1/4
Solid Pine
Reversible Base **N**



305SP 7/16 x 2-1/2
Solid Pine
Streamline Base **S**

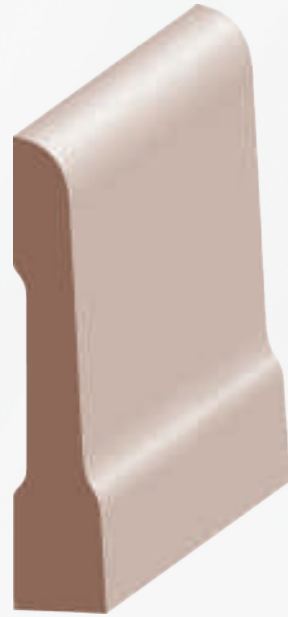

309SP 1/2 x 2-1/2
Solid Pine
Combo Base & Shoe **S**



310SP 1/2 x 2-1/2
Solid Pine
#711 Base **S**

310SP-SC 7/16 x 2-1/2
Solid Pine Scant
#711 Base **S**

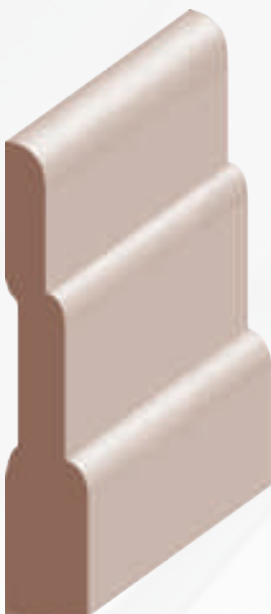

321SP-2 1/2 x 2-1/2
Solid Pine 3-Step Base **S**
(FORMERLY 312SP-2)



313SP 7/16 x 2-1/2
Solid Pine #1550 Base **S**

3-1/4" to 3-1/2" Base

lengths available: 8' thru 16'

(arranged in order of width; items are approximate scale only)

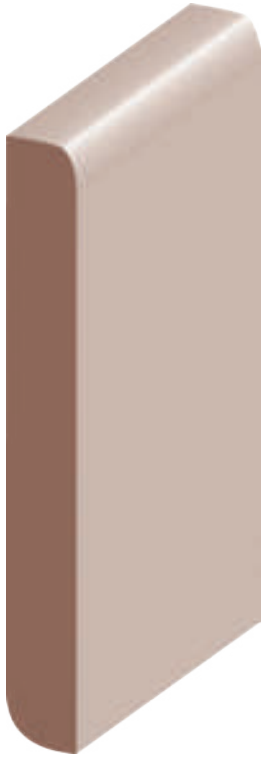

R304SP-3 3/8 x 3-1/4
Solid Pine Reversible Base **N**

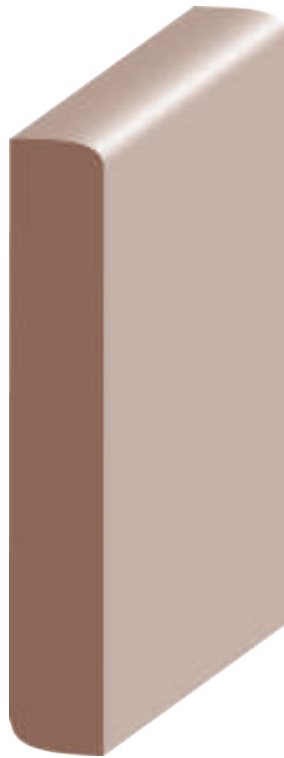

R306SP-3 1/2 x 3-1/4
Solid Pine Reversible Base **N**



307BSP 1/2 x 3-1/4
Solid Pine Streamline Base **N**

307SP 7/16 x 3-1/2
Solid Pine Streamline Base **S**

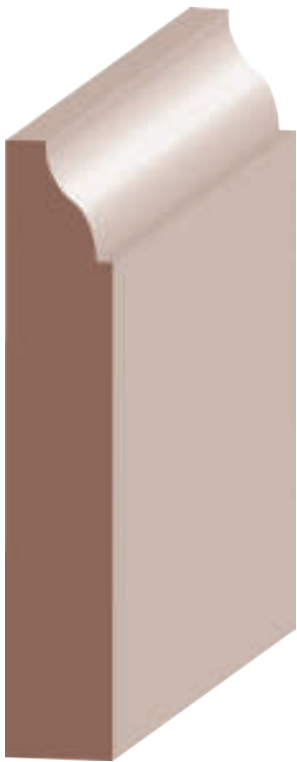

314SP-3 9/16 x 3-1/4
Solid Pine Coronado/#623 Base **N/S**



320SP 1/2 x 3-1/4
Solid Pine Colonial/#356 Base **N/S**



117SP 9/16 x 3-1/2
Solid Pine Colonial Base/Casing **S**



3-1/2" to 4-1/4" Base

lengths available: 8' thru 16'

(arranged in order of width; items are approximate scale only)



311SP 7/16 x 3-1/2
Solid Pine #711 Base **S**



321SP-3 1/2 x 3-1/2
Solid Pine 3 Step Base **N/S**



318SP-4 9/16 x 4
Solid Pine
Cape Cod Base **S**

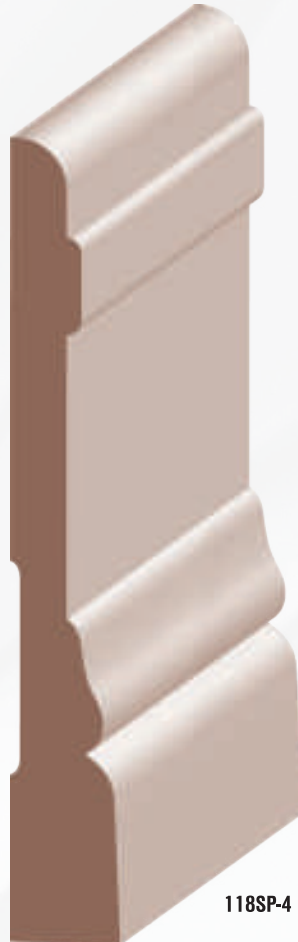

118SP-4 9/16 x 4-1/4
Solid Pine
Colonial Base/Casing **S**



(arranged in order of width; items are approximate scale only)

5-1/4" to 5-1/2" Base

lengths available: 8' thru 16'



314SP-5 9/16 x 5-1/4
Solid Pine Coronado/#618 Base **N/S**



318SP-5 9/16 x 5-1/4
Solid Pine Cape Cod Base **N/S**

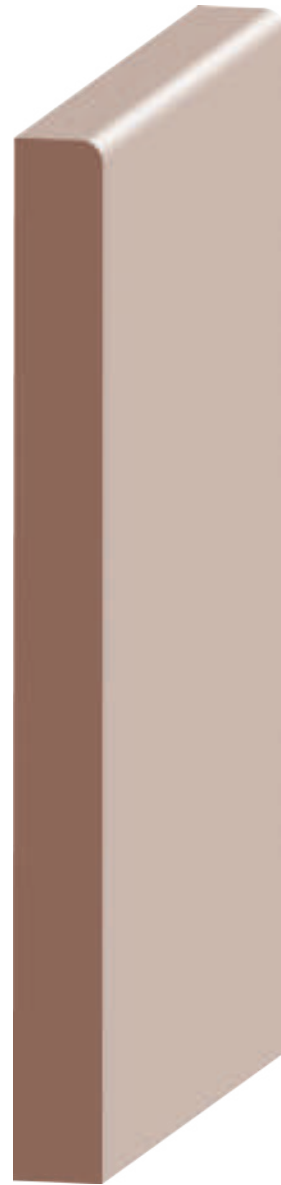

387SP-5 1/2 x 5-1/2
Solid Pine 1 Eased Edge
Craftsman Base **N/S**

1-5/8" to 3-5/8" Crown

lengths available: 8" thru 16"

(arranged in order of width; items are approximate scale only)

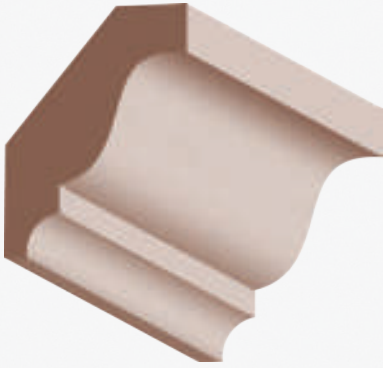

400SP 9/16 x 1-5/8 **Solid Pine Colonial Crown** N

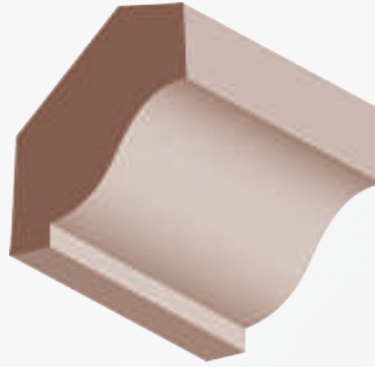

401SP-1 9/16 x 1-5/8 **Solid Pine Crown** S
(FORMERLY E400)

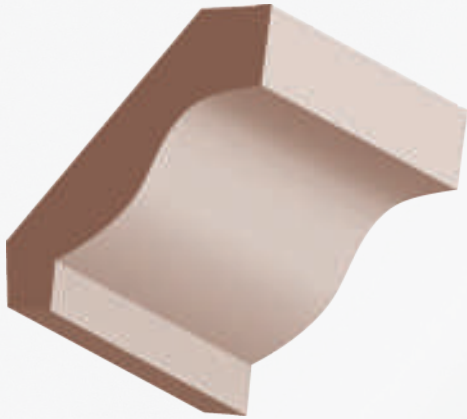

401SP-2 9/16 x 2-1/4 **Solid Pine Crown** S
(FORMERLY E401)

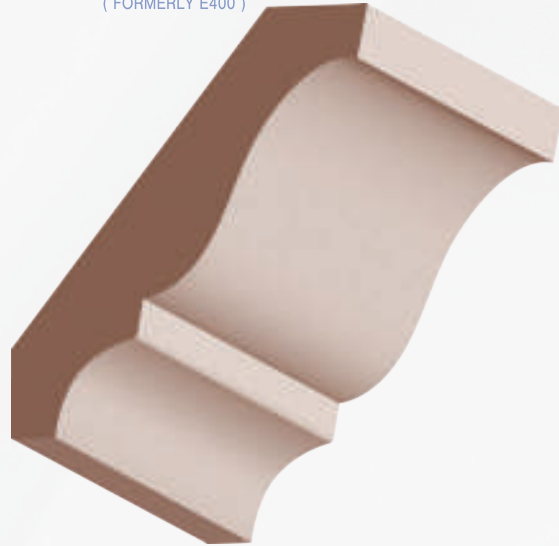

436SP 9/16 x 2-3/4 **Solid Pine Colonial Crown** N

418SP 9/16 x 2-1/4 **Solid Pine Colonial Crown** S



401SP-3 9/16 x 3-1/2 **Solid Pine Crown** S

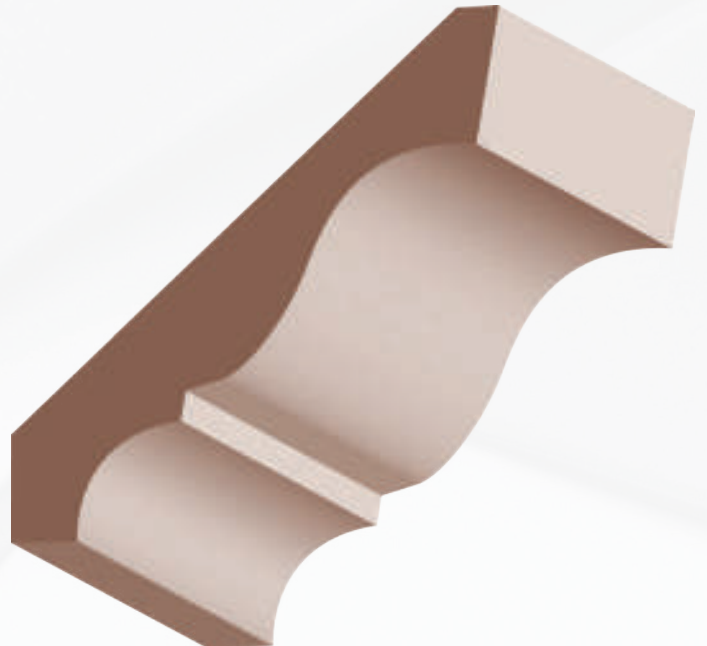

405BSP 9/16 x 3-5/8 **Solid Pine Colonial Crown** N

405SP 9/16 x 3-3/8 **Solid Pine Colonial Crown** S



(arranged in order of width; items are approximate scale only)

4-1/4" to 4-1/2" Crown

lengths available: 8' thru 16'

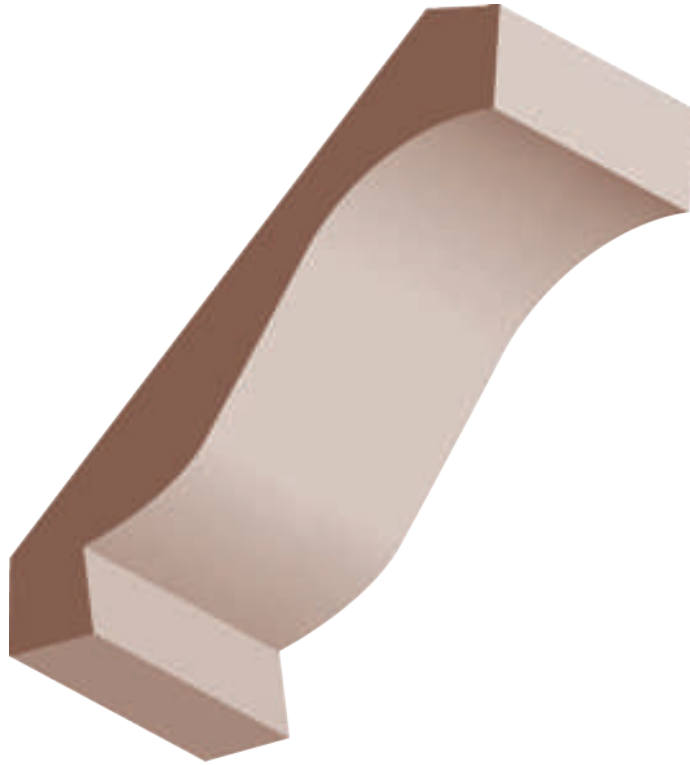

403SP 9/16 x 4-1/4
Solid Pine Crown **S**

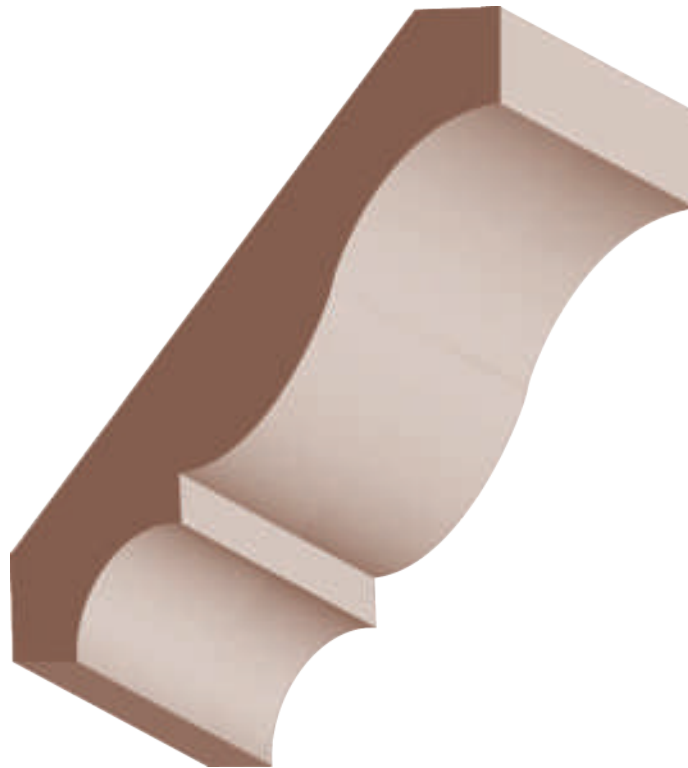

406SP 9/16 x 4-1/2
Solid Pine Colonial Crown **N/S**



4-1/2" to 5-1/4" Crown

lengths available: 8' thru 16'

(arranged in order of width; items are approximate scale only)

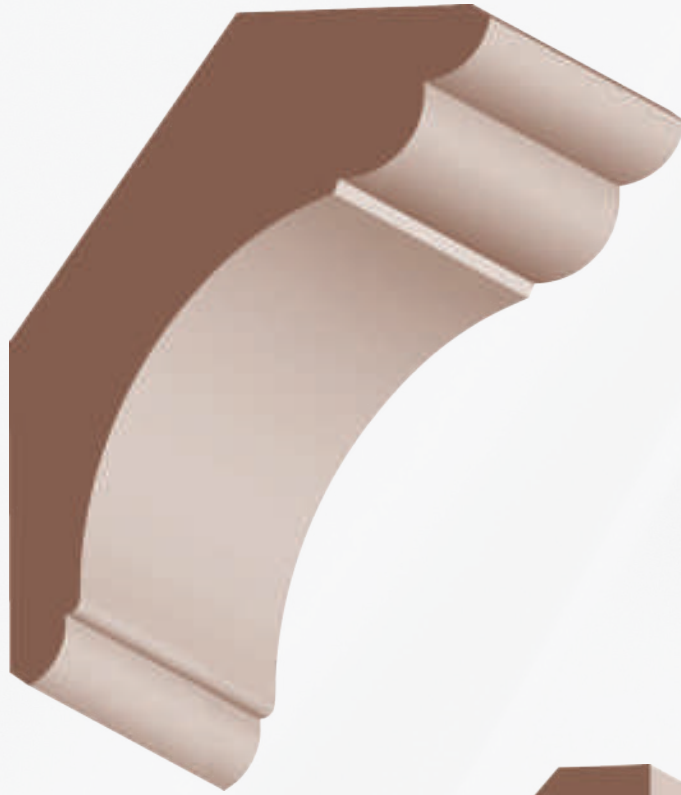

407SP 1-1/8 x 4-1/2
Solid Pine Cornice **S**



414SP 9/16 x 5-1/4
Solid Pine Colonial Crown **N/S**

(arranged in order of width; items are approximate scale only)

5-1/2" to 6" Crown

✦ lengths available: 8' thru 16'

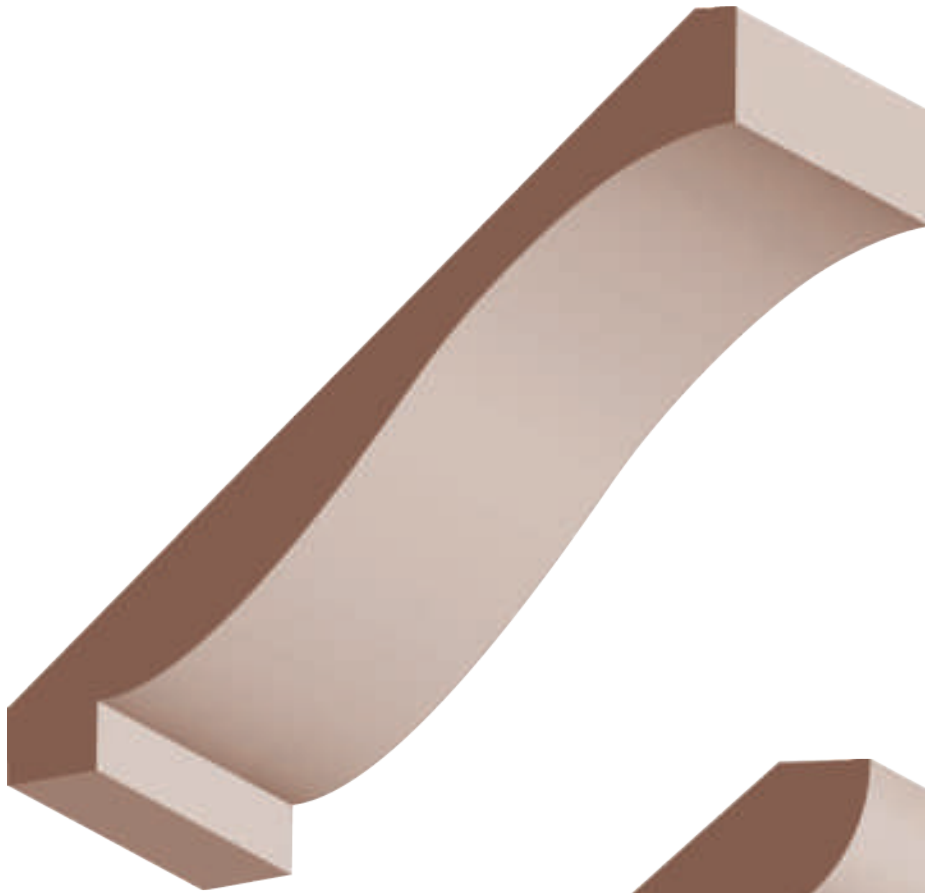

404SP 9/16 x 5-1/2
Solid Pine Crown **S**

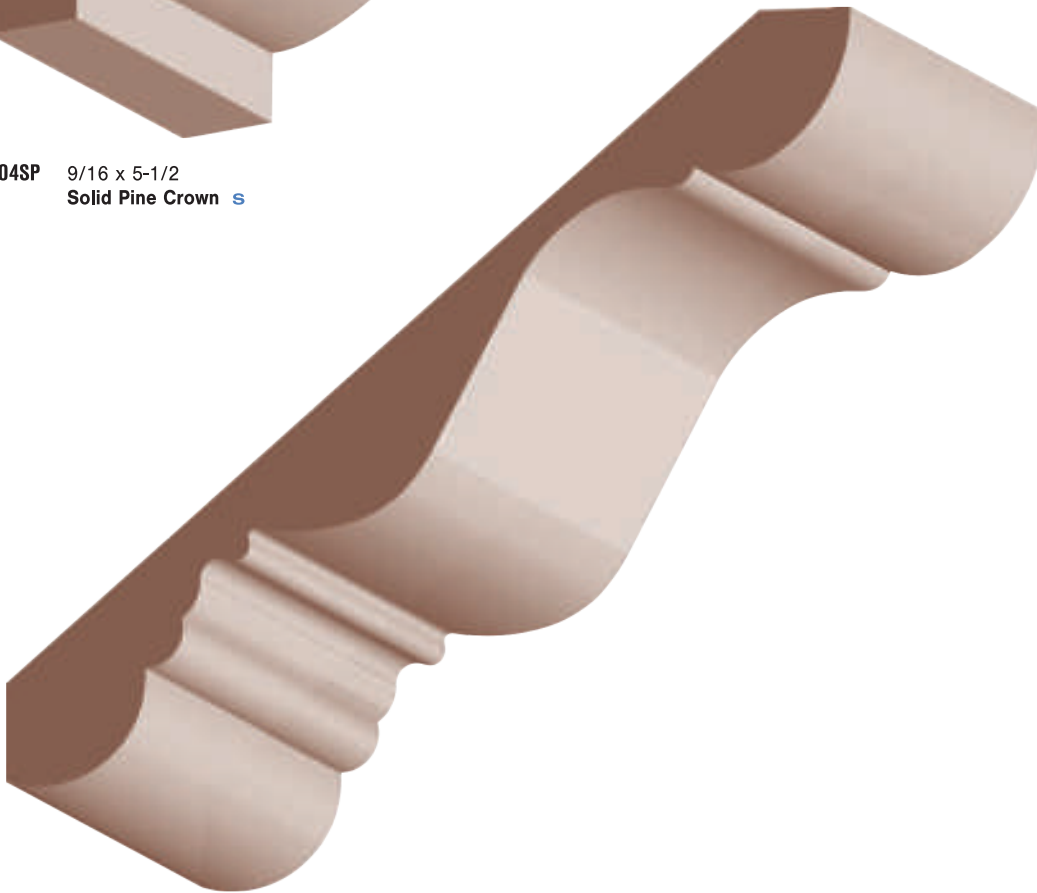

410SP-6 11/16 x 6
Solid Pine Charleston Crown **S**



Half Round

lengths available: 8' thru 16'



- Solid Pine Half Round**
- 570SP 1/4 x 1/2 N/S
 - 571SP 5/16 x 5/8 N/S
 - 572SP 3/8 x 3/4 N/S
 - 573SP 1/2 x 1 N/S
 - 574SP 5/8 x 1-1/4 S

Quarter Round

lengths available: 8' thru 16'



- Solid Pine Quarter Round**
- 500SP 1/4 x 1/4 N/S
 - 501SP 3/8 x 3/8 N/S
 - 502SP 1/2 x 1/2 N/S
 - 503SP 5/8 x 5/8 N/S
 - 504SP 3/4 x 3/4 N/S
 - 505SP 1 x 1 N/S

(arranged in order of width; items are approximate scale only)

Cove

lengths available: 8' thru 16'



- 520SP 3/8 x 3/8
Solid Pine Cove S



- 521SP 1/2 x 1/2
Solid Pine Cove N/S



- 522SP 5/8 x 5/8
Solid Pine Cove S



- 523SP 3/4 x 3/4
Solid Pine Cove N/S



- 528SP 3/4 x 3/4
Solid Pine Decorative Cove N

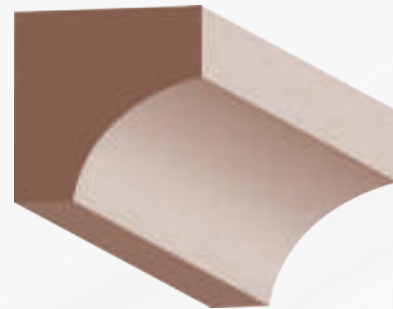

- 524SP 1 x 1
Solid Pine Cove N/S



- 527BSP 5/8 x 1-1/2
Solid Pine Linoleum Cove N
-
- 527SP 7/16 x 1-1/4
Solid Pine Linoleum Cove S



- 525BSP 11/16 x 1-3/4
Solid Pine Sprung Cove N
-
- 525SP 5/8 x 1-5/8
Solid Pine Sprung Cove S

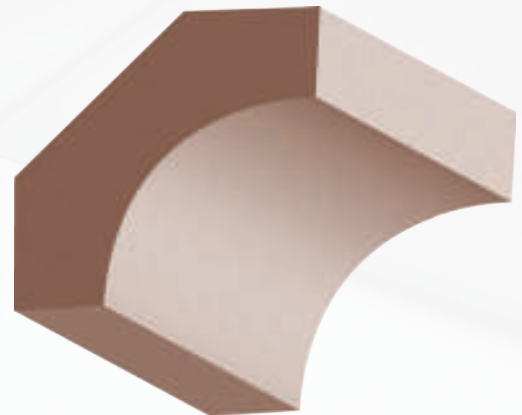

- 526SP 5/8 x 2-1/4
Solid Pine Sprung Cove N/S

(arranged in order of width; items are approximate scale only)

Screen / Scribe / Bead



590SP 3/16 x 1/2
Solid Pine Insert **N/S**



591SP 1/4 x 3/4
Solid Pine Flat Screen Mold **N/S**



593SP 3/16 x 3/4
Solid Pine Scribe Mold **N/S**



592SP 1/4 x 3/4
Solid Pine Beaded Screen Mold **N/S**



597SP 3/8 x 3/8
Solid Pine Glass Bead **N/S**



596SP 1/4 x 7/16
Solid Pine Glass Bead **S**



594SP 3/8 x 3/4
Solid Pine Cloverleaf **N/S**

Chair Rail

lengths available: 8" thru 16"

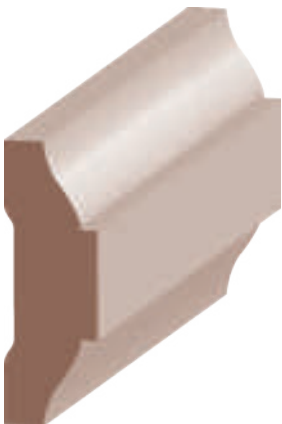

650SP 1/2 x 1-1/2
Solid Pine Chair Rail **S**



651BSP 9/16 x 2
Solid Pine Chair Rail **N**

651SP 9/16 x 2-1/2
Solid Pine Chair Rail **S**



145SP 5/8 x 2-5/8
Solid Pine Coronado Casing/Chair Rail **N**

652SP 11/16 x 2-1/2
Solid Pine Colonial Chair Rail **S**



Astragal

(arranged in order of width; items are approximate scale only)



646SP 11/16 x 1-5/8
Solid Pine Flat Astragal/Panel Mold N



662SP 1-1/4 x 2
Solid Pine T-Astragal N/S
 (for 1-3/8" Door)

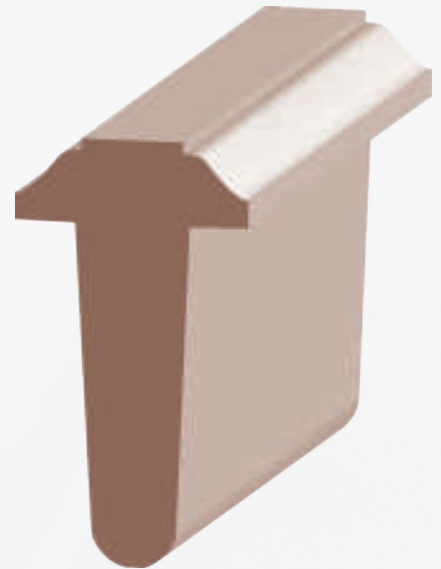

661SP 1-1/4 x 2-1/4
Solid Pine T-Astragal S
 (for 1-3/4" Doors)

lengths available: 7' thru 16'

lengths available: 7' and 8' only

lengths available: 7' & 8' only

Panel Cap

lengths available: 8' thru 16' only

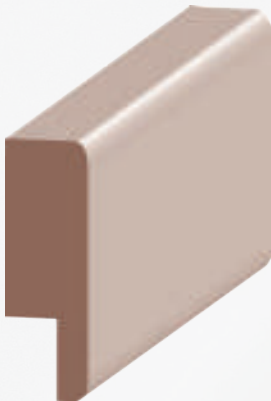

623SP 7/16 x 1-3/8
Solid Pine Wainscot Cap N
 [with 3/8" Rab't]



624SP 9/16 x 1-1/8
Solid Pine Panel Cap N
 [with 1/4" x 3/8" Rab't]



625SP 3/4 x 2
Solid Pine Large Panel Cap N
 [with 1/4" x 1-1/8" Rab't]



620SP 3/4 x 1-1/2
Solid Pine Panel Cap N/S
 [with 3/8" Rab't]



Panel & Decorative

lengths available: 8' thru 16'

(arranged in order of width; items are approximate scale only)



600SP 3/8 x 5/8
Solid Pine Panel Mold **N/S**



601SP 5/8 x 3/4
Solid Pine Panel Mold **N/S**



615SP 9/16 x 3/4
Solid Pine Base Cap **N**

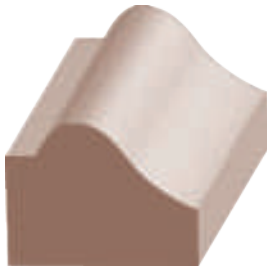

602SP 3/4 x 1
Solid Pine Panel Mold **N/S**



604SP 3/8 x 1-1/8
Solid Pine Panel Mold **S**

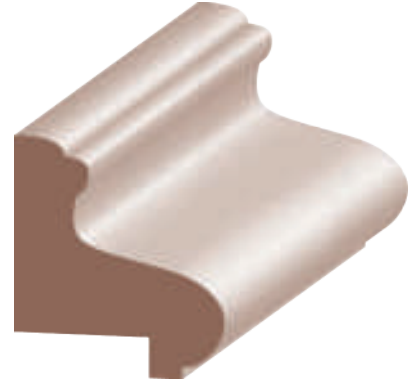

613SP 1-1/8 x 1-1/4
Solid Pine Raised Panel Cap **N/S**
[with 1/4" x 3/4" Rab't]



731SP 5/8 x 1-1/4
Solid Pine Wainscot Cap **S**
[with 1/4" Rab't]



606SP 9/16 x 1-3/8
Solid Pine Panel Mold **N/S**



614SP 11/16 x 1-3/8
Solid Pine Coronado Base Cap/Panel Cap **N/S**



605SP 3/4 x 1-5/8
Solid Pine Panel Mold **N/S**



603SP 1-1/16 x 1-1/2
Solid Pine Panel/Brick Mold **S**



730SP 1/2 x 1-1/2
Solid Pine Panel Cap **S**
[with 1/8" Rab't]



Panel & Decorative

(arranged in order of width; items are approximate scale only)



607SP 5/8 x 1-5/8
Solid Pine Beauty Mold **S**



608SP 3/4 x 1-7/8
Solid Pine Beauty Mold **S**

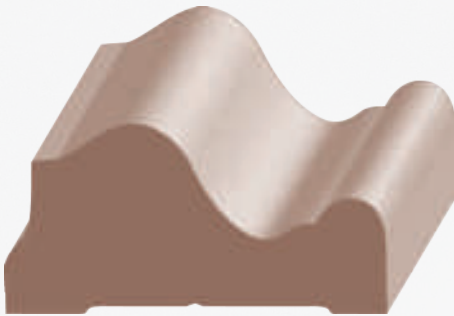

610SP 1 x 2
Solid Pine Decorative Panel Mold **S**



611SP 1-3/8 x 3-1/4
Solid Pine Decorative Panel Mold **S**

Outside Corner Guard

lengths available: 8" thru 16"



720SP 3/4 x 3/4
Solid Pine Outside Corner Guard **N/S**



721SP 1 x 1
Solid Pine Outside Corner Guard **N/S**



723SP 1-1/8 x 1-1/8
Solid Pine Decorative Outside Corner Guard **N/S**



722SP 1-3/8 x 1-3/8
Solid Pine Outside Corner Guard **N/S**

(arranged in order of width; items are approximate scale only)

Lattice / S4S / Full Round

lengths available: 8' thru 16'



Solid Pine Lattice

700SP	1/4 x 1-1/8	N/S
701SP	1/4 x 1-1/4	S
701BSP	1/4 x 1-3/8	N
702SP	1/4 x 1-5/8	S
702BSP	1/4 x 1-3/4	N
703SP	1/4 x 2-1/2	S
703BSP	1/4 x 2-1/4	N
704SP	1/4 x 3-1/2	N/S



705SP	1/2 x 1/2		S4S	N/S
706SP	1/2 x 3/4		S4S	N/S
707SP	1/2 x 1-1/2		S4S	N/S
708SP	1/2 x 2-1/2		S4S	N/S
709SP	1/2 x 3-1/2		S4S	N/S
710SP	1/2 x 5-1/2		S4S	N/S
711SP	3/4 x 3/4		S4S	N/S
712SP	11/16 x 1-1/4		S4S	S
713SP	11/16 x 1-5/8	(1x2)	S4S	N/S
714SP	11/16 x 2-1/2	(1x3)	S4S	N/S
715SP	11/16 x 3-1/2	(1x4)	S4S	N/S
716SP	1 x 1	(1x1)	S4S	N/S
717SP	1-9/16 x 1-9/16	(2x2)	S4S	N/S
719SP	1-1/2 x 1-1/2	(2x2)	4EE S4S	S
750SP	3/4 x 5-1/2	(1x6)	C&BTR S4S	N/S
751SP	3/4 x 7-1/4	(1x8)	C&BTR S4S	N/S
752SP	3/4 x 9-1/4	(1x10)	C&BTR S4S	S
753SP	3/4 x 11-1/4	(1x12)	C&BTR S4S	N/S
715KP	3/4 x 3-1/2	(1x4)	#2 COMMON S4S	N
750KP	3/4 x 5-1/2	(1x6)	#2 COMMON S4S	N
751KP	3/4 x 7-1/4	(1x8)	#2 COMMON S4S	N
752KP	3/4 x 9-1/4	(1x10)	#2 COMMON S4S	N
753KP	3/4 x 11-1/4	(1x12)	#2 COMMON S4S	N
758KP	1-1/2 x 11-1/4	(2x12)	#2 COMMON S4S	N

Full Round

lengths available: 6' - 16'



Solid Pine Full Round

800SP	3/4"	N
801SP	1"	N
802SP	1-1/4"	N/S
803SP	1-3/8"	S
807SP	1-5/8"	N

Exterior Molds

lengths available: 7' thru 16'

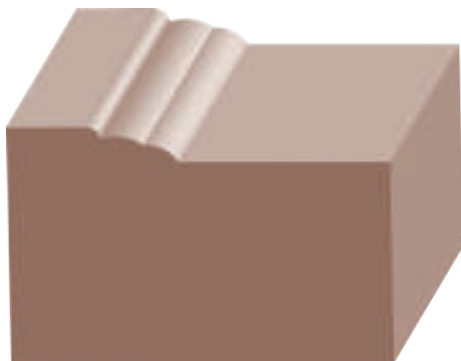

612ASP 1-1/4 x 2
Solid Pine #180 Eastern Brick Mold N/S
 without Stucco Key



612BSP 1-1/4 x 2
Solid Pine #180 Eastern Brick Mold N/S
 with Stucco Key



Clear Pine T&G Wainscot

lengths available: 3' thru 16'

(arranged in order of width; items are approximate scale only)



2000SP 3/8 x 3-3/8 **Solid Pine Beaded T&G Wainscot** N
2002SP 9/16 x 5-1/2 **Solid Pine Beaded T&G Wainscot** N/S

2001SP 3/8 x 3-3/8 **Solid Pine Flat T&G Wainscot** N
2003SP 9/16 x 5-1/2 **Solid Pine Flat T&G Wainscot** N/S

Knotty Pine T&G Wainscot

lengths available: 6' thru 16'



2000KP 3/8 x 3-1/4 **Knotty Pine Beaded T&G Wainscot** S

2001KP 3/8 x 3-3/8 **Knotty Pine Flat T&G Wainscot** S

Window Stool

lengths available: 8' thru 16'



990SP 11/16 x 4-1/2 **Solid Pine Ogee Window Stool** N
992SP 11/16 x 5-1/2 **Solid Pine Ogee Window Stool** N



979SP 11/16 x 5-1/2 **Solid Pine Flat Window Stool** S
980SP 11/16 x 4-3/4 **Solid Pine Flat Window Stool** S
985SP 11/16 x 7-1/4 **Solid Pine Flat Window Stool** S



981SP 7/8 x 2-1/2 **Solid Pine Rabbeted Window Stool** S
982SP 7/8 x 3-1/2 **Solid Pine Rabbeted Window Stool** S
984SP 7/8 x 5-1/2 **Solid Pine Rabbeted Window Stool** S

Miscellaneous

(arranged in order of width; items are approximate scale only)

✦ lengths available: 8' thru 16'



901SP 3/8 x 3/4
Solid Pine Parting Bead **N/S**



903SP 3/8 x 1
Solid Pine Flat Hoffco **S**

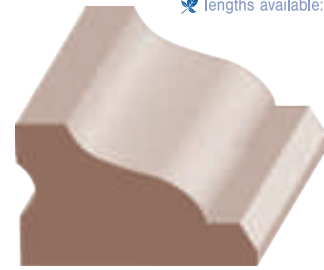

904SP 3/4 x 1-1/4
Solid Pine Drip Mold **S**



900SP 11/16 x 1-5/8
Solid Pine Band Mold **S**



916SP 3/4 x 1-3/4
Solid Pine Picture Mould **N**

905SP 11/16 x 1-5/8
Solid Pine #1139 Picture Mould **S**

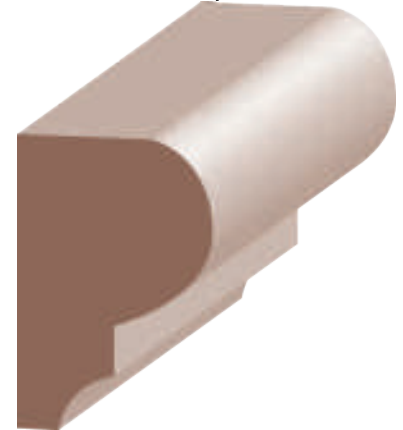

909SP 1 x 1-5/8
Solid Pine Nose & Cove **N/S**



911SP 11/16 x 1-5/8
Solid Pine Rab't Shelf Cleat **N**
[with 3/8" x 11/16" Rab't]

Chamfer

✦ lengths available: 8' thru 16'



906SP 1/2 x 1/2
Solid Pine Chamfer **N/S**



907SP 3/4 x 3/4
Solid Pine Chamfer **N/S**



908SP 1 x 1
Solid Pine Chamfer **N/S**

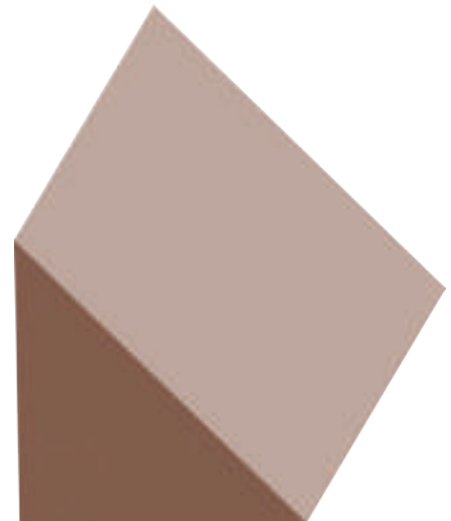

912SP 1-1/2 x 1-1/2
Solid Pine Chamfer **N**

Weatherstrip Kerfed Exterior Door Frames

(arranged in order of width; items are approximate scale only)

1-3/4" doors only



Exterior Door Frame Specs

- ☞ 1-1/4" Thick
- ☞ 6/8 = 82-1/2" Below Dado
- ☞ 8/0 = 98-1/2" Below Dado
- ☞ No Screen Rabbet
- ☞ Single End Dado (Except on Lineal)
- ☞ 3 Pair Per Bundle
- ☞ Kerfing for Bullnose is Available
- ☞ Ripped to Width Available
- ☞ Rab't Measures 1/2" x 2-1/8"

EXTERIOR DOOR FRAMES Weatherstrip Kerfed			
For 1/2" x 2-1/8" Door Rab't.			
	Solid Pine		
SIZE	6/8	8/0	
4-1/8	418WSP6	418WSP8	N/S
4-5/8	458WSP6	458WSP8	N/S
5-1/4	514WSP6	514WSP8	N/S
6-5/8	658WSP6	658WSP8	N/S
7-1/4	714WSP6	714WSP8	N/S

Standard Frame for 1-3/4" Doors

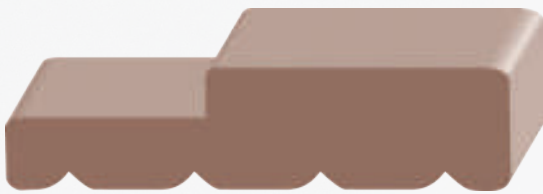

EXTERIOR DOOR FRAMES Standard			
For 1/2" x 1-13/16" Door Rab't.			
	Solid Pine		
SIZE	6/8	8/0	
4-1/8	418SP6	418SP8	N/S
4-5/8	458SP6	458SP8	N/S
5-1/4	514SP6	514SP8	N/S
6-5/8	658SP6	658SP8	N/S
7-1/4	714SP6	714SP8	N/S

Window Jamb Extension



JAMBEXT 11/16 x 3-15/16 **Jamb Extension N**
(for Andersen® windows)

Interior Door Jambs



Kerfing for bullnose is available on all jamb sizes and species. Custom size odd wall widths available upon request.

INTERIOR DOOR JAMBS								
	Solid Pine				Veneer			
SIZE	6/8	8/0		SIZE	6/8	8/0		
4-9/16	4916SPI6	4916SPI8	N/S	4-9/16	4916PVI6	4916PVI8	N	
4-13/16	434SPI6	434SPI8	N	4-13/16	434PVI6	-	N	
5-1/4	514SPI6	514SPI8	N/S	5-1/4	514PVI6	-	N	
6-9/16	-	-	-	6-9/16	6916PVI6	-	N	
7-1/4	714SPI6	714SPI8	N/S	7-1/4	714PVI6	-	N	

Interior Door Jamb Specs

- ☞ 11/16" Thick
- ☞ 6/8 = 81" Below Dado N
- ☞ 8/0 = 97" Below Dado N
- ☞ Solid Pine jambs may have a glue line where door stop is applied
- ☞ 80-5/8" Below Dado S
- ☞ 96-5/8" Below Dado S
- ☞ Random Lengths only available in most Solid Wood Species
- ☞ Dado depth is 3/8"
- ☞ Heads cut 3/4 over opening
- ☞ 5 pair per bundle



Primed & Unprimed Finger-Joint Pine

THE ECONOMICAL CHOICE FOR PAINTED WOOD



Finger-Joint (FJ) Pine consists of small pieces of wood that are recycled and jointed together (repurposed) to create lengths for door casings in 7' or 17' lengths, as well as 16' for crowns, base and chair rails. The advantages to FJ Pine mouldings are the definition of detail, much sharper than MDF, the workability, nailing ease and personal preference for wood. FJ Pine can have some imperfections, grain variances for one, as all natural woods have. Close inspection prior to installation and painting is key. Primed FJ moulding is coated with a water-based gesso. Each piece of moulding is ready for paint once prepping is complete. Please note that 10% of trimbacks (length other than specified) are allowed.

section contents

Base / Base Shoe	138
Apron.....	175
Casing.....	125
Chair Rail.....	170
Cove	171
Crown.....	154
Door Header	125
Door Stop.....	137
Exterior Brick & Stucco Mould	177
Exterior Door Frames.....	180
Flat Astragal.....	171
Full Round	171
Hook & Cleat.....	176
Interior Door Jambs	182
Nosing.....	176
Panel Mold	172
Panel Mold & Cap.....	173
Quarter Round	171
S4S.....	178
T-Astragal	171
Wainscot.....	179
Weatherstrip Kerfed Ext. Door Frames...	181
Window Stool.....	175

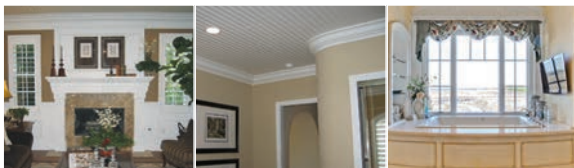

guide

SPECIES

Primed & Unprimed Finger-Joint Pine

INTERIOR/EXTERIOR

I/*E

DESIGN STYLES

TRADITIONAL | CONTEMPORARY | COLONIAL

JANKA
HARDNESS
(POUNDS-FORCE)

710

FINISHING

1

Priming and painting the moulding before it is installed is recommended. Ensure all areas that have filler are dry and sanded before applying any primer or paint.

3

Painting is recommended for moulding surfaces already coated with a primer. In most applications a semigloss coat for durability, washability, and appearance is recommended.

2

If you install the moulding and then finish it, protect the area around the moulding by masking it off with tape. Carefully remove the tape immediately after finishing to prevent its drying to the finish.

4

Please ensure that only higher quality paints with high solids content are used. Two finish coats are recommended for top quality durability and appearance. Water added to paint for dilution can and often causes excess moisture and adversely affects wood.



COMPARED TO SOLID WOOD, FJ MOULDINGS MAKE BETTER USE OF HARVESTED TREES, ARE MORE DIMENSIONALLY STABLE AND LESS LIKELY TO WARP, CUP, OR SPILT. FJ MOULDINGS ARE NOT SUITABLE FOR STAINING BUT GREAT FOR PAINTING.

CUT LIST

Determining How Much You Need

- 1 Measure the room at the height or length where each moulding goes to determine the number and the length of the pieces you'll need.
- 2 FJ primed or unprimed casing and stop is available in 7' on select profiles, 17' on all casing profiles and 16' or 17' on door stop. When figuring how much footage your project requires, for each type of moulding, base, casing, crown, etc., measure your walls or openings and add the footage. Then multiply the footage by 1.1. The result is the total footage needed plus 10% for waste.
- 3 When ordering casing for 6/8 doors: Jambs that are 80-5/8" BD use 7' casing on profiles 3" wide or smaller. Use 17' casing for profiles wider than 3" or for 8/0 doors. Jambs that are 81" BD use 7' casing on profiles 2-1/4" or smaller and 17' casing for profiles wider than 2-1/4" or for 8/0 doors.
- 4 Most door heads are cut from 7' legs (2- 3/0 heads on ONE or BOTH sides of door opening). Always cut the longest pieces first: door legs, window legs, long window heads and sills, and then door heads.
- 5 The most important tool when working with moulding is **patience**. Remember the old adage, measure twice and cut once. Never try to rush trim work.
- 6 Lengths ordered may not always be available. Always verify availability when ordering.

ALWAYS TEST TO MAKE SURE YOUR MEASURING TOOLS ARE ACCURATE. IF YOU ARE WORKING WITH A HELPER, TAKE A MEASUREMENT WITH ONE TOOL WHILE YOUR HELPER MEASURES WITH ANOTHER AND COMPARE YOUR RESULTS.

HELPFUL HINTS

- * Chair rails can be installed 32" to 36" from the floor.
- * Base, shoe, and quarter rounds should be the last mouldings to be installed.
- * Use any brand of spray furniture polish on saw blade as a lubricant for easier cutting.
- * Use Rosettes and Plinth blocks at the corners of windows and doors to eliminate the mitering process.
- * After installation is complete, caulk and/or putty all gaps and nail holes.
- * CHECK the moisture content of all wood moulding: for interior trim, the MC should be 8-10%; for exterior trim the MC should be 12-14%. For every 4% change in MC, wood moves 1%.

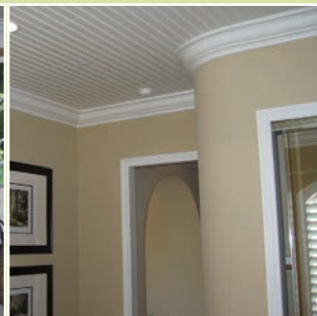

*EXTERIOR ITEMS CAN BE FOUND ON P.177, 180, 181



(items are approximate scale only)

1" to 1-5/8" Casing & Door Header

✂ Lengths available: 7' & 17' on profiles up to 2-1/4" wide only – 17' if profile is wider than 2-1/4" [Ⓜ] Mitered pairs available in 7'



PR193FJ 1 1/16 x 1
Primed FJ Back Band ^N
[Lips 5/8" casing]



PR192FJ 1-1/8 x 1-1/4
Primed FJ Back Band ^N
[Lips 5/8" casing]

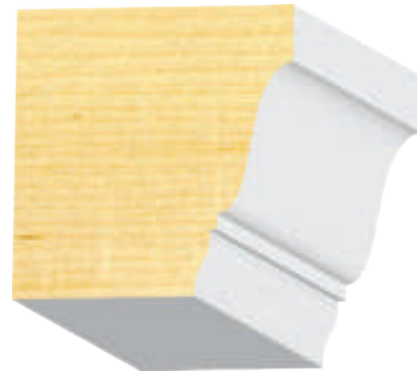

PRHC150FJ 1-5/16 x 2-1/4
Primed FJ Door Header Cap ^{N/S}



PR969FJ 7/16 x 1-1/4
Primed FJ
2 EE Door Header Fillet ^{N/S}



151FJ 9/16 x 1-1/2
Unprimed FJ Pre-fit Casing ^S



PR100FJ 9/16 x 1-5/8
Primed FJ 2 Round Edge Casing ^{N/S}

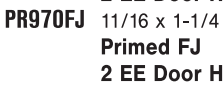

PR970FJ 1 1/16 x 1-1/4
Primed FJ
2 EE Door Header Fillet ^{N/S}



101FJ 1/2 x 1-5/8
Unprimed FJ
Streamline Casing ^S



PR102FJ 5/8 x 1-5/8
**Primed FJ Beveled/
Streamline Casing** [Ⓜ] ^{N/S}



PR107FJ 5/8 x 1-5/8
Primed FJ #711 Casing [Ⓜ] ^S



102FJ 5/8 x 1-5/8
**Unprimed FJ Beveled/
Streamline Casing** [Ⓜ] ^{N/S}



107FJ 5/8 x 1-5/8
Unprimed FJ #711 Casing ^S



PR130FJ 5/8 x 1-5/8
Primed FJ Moulded Casing ^N



PR142FJ 9/16 x 1-5/8
Primed FJ Oval Casing ^N



PR152FJ-1 5/8 x 1-5/8
Primed FJ Colonial 356 Casing ^N



2 to 2-1/4" Casing

(items are approximate scale only)

✂ Lengths available: 7' & 17' on profiles up to 2-1/4" wide only –
 17' if profile is wider than 2-1/4" (M) Mitered pairs available in 7'



121FJ 11/16 x 2
Unprimed FJ Clamshell Casing S



153FJ 9/16 x 2
Unprimed FJ #356 Casing S



PR103BFJ 5/8 x 2-1/4
Primed FJ Beveled/Streamline Casing (M) N/S

103BFJ 5/8 x 2-1/4
Unprimed FJ Beveled Casing (M) N

103FJ 11/16 x 2-1/2
Unprimed FJ Streamline Casing (M) S



PR110BFJ-2 5/8 x 2-1/4 **Primed FJ 3-Step Casing** N/S

110FJ 5/8 x 2-1/2 **Unprimed FJ 3-Step Casing** S

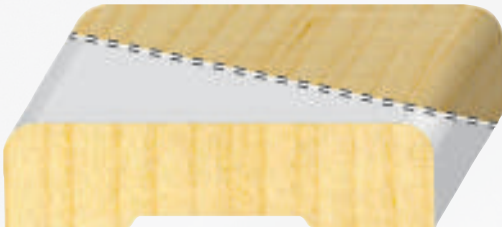

PR120FJ 9/16 x 2-1/4 **Primed FJ 2 Round Edge Casing** N/S

120FJ 9/16 x 2-1/4 **Unprimed FJ 2 Round Edge Casing** N



PR141FJ 5/8 x 2-1/4 **Primed FJ Moulded Casing** N



PR143FJ 9/16 x 2-1/4 **Primed FJ Oval Casing** N



PR149FJ-2 5/8 x 2-1/4 **Primed FJ Meridian Casing** N/S

(items are approximate scale only)

2-1/4" to 2-1/2" Casing

✂ Lengths available: 7' & 17' on profiles up to 2-1/4" wide only – 17' if profile is wider than 2-1/4"  Mitered pairs available in 7'



PR152FJ 11/16 x 2-1/4 **Primed FJ Colonial/#356 Casing**  **N/S**
152FJ 11/16 x 2-1/4 **Unprimed FJ Colonial/#356 Casing**  **N/S**

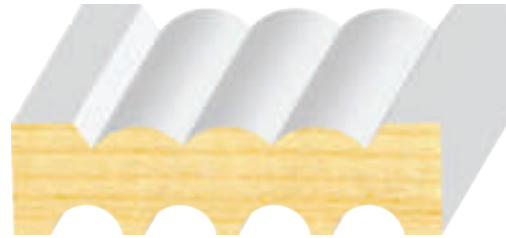

PR158FJ-2 11/16 x 2-1/4
Primed FJ Reversible 4-Flute & Reed Casing **N**



PR162FJ 5/8 x 2-1/4 **Primed FJ Anderson Casing** **N**
162FJ 5/8 x 2-1/4 **Unprimed FJ #366 Casing** **S**
162BFJ 11/16 x 2-1/2 **Unprimed FJ #366 Casing** **S**



PR128FJ 5/8 x 2-7/16 **Primed FJ Mission/Bel-Air Casing** **N/S**
128FJ 5/8 x 2-7/16 **Unprimed FJ Bel-Air Casing** **S**



PR132FJ 11/16 x 2-7/16 **Primed FJ Carolina/Palisade Casing** **N/S**



PR137FJ 11/16 x 2-7/16 **Primed FJ Carmel Casing** **N/S**



PR167FJ 11/16 x 2-7/16 **Primed FJ Santa Fe/#275 Casing** **N/S**
167FJ 11/16 x 2-7/16 **Unprimed FJ #275 Casing** **S**



PR108FJ 5/8 x 2-1/2 **Primed FJ #711 Casing** **S**
108FJ 5/8 x 2-1/2 **Unprimed FJ #711 Casing** **S**

2-1/2" Casing

(items are approximate scale only)

✂ Lengths available: 7' & 17' on profiles up to 2-1/4" wide only –
 17' if profile is wider than 2-1/4" **M** Mitered pairs available in 7'



115FJ 5/8 x 2-1/2 **Unprimed FJ Universal Casing** **S**

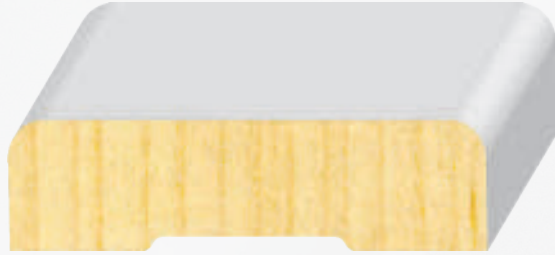

PR120BFJ 11/16 x 2-1/2 **Primed FJ 2RE Casing** **N/S**



PR131FJ 11/16 x 2-1/2 **Primed FJ Riviera Casing** **M N/S**



PR150FJ 5/8 x 2-1/2 **Primed FJ Cape Cod Casing** **N/S**
150FJ 5/8 x 2-1/2 **Unprimed FJ Cape Cod Casing** **S**



PR157FJ 1-1/4 x 2-1/2 **Primed FJ Coronado Casing** **S**
157FJ 1-1/4 x 2-1/2 **Unprimed FJ Coronado Casing** **S**



PR159FJ 1 x 2-1/2 **Primed FJ Hermosa Casing** **S**
159FJ 1 x 2-1/2 **Unprimed FJ Hermosa Casing** **S**



PR163FJ 5/8 x 2-1/2 **Primed FJ Monterey Casing** **S**
163FJ 5/8 x 2-1/2 **Unprimed FJ Monterey Casing** **S**



164FJ 1-1/4 x 2-1/2 **Unprimed FJ Bell Court Casing** **S**

(items are approximate scale only)

2-1/2" to 3" Casing

✦ Lengths available: 7' & 17' on profiles up to 2-1/4" wide only – 17' if profile is wider than 2-1/4" Ⓜ Mitered pairs available in 7'



PR169FJ 1 1/16 x 2-1/2 **Primed FJ Victorian/Tudor Casing** N/S
169FJ 1 1/16 x 2-1/2 **Unprimed FJ Tudor Casing** S

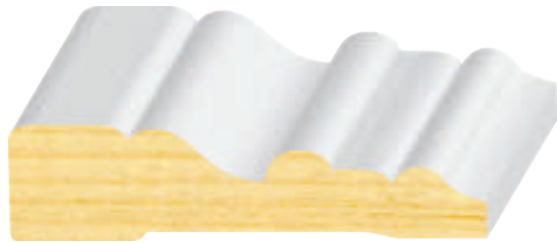

PR175FJ-2 5/8 x 2-1/2 **Primed FJ Sierra Casing** N/S



PR123FJ 5/8 x 2-9/16 **Primed FJ Montecito Casing** S



PR172FJ-2 1 1/16 x 2-1/2 **Primed FJ Contemporary Casing** N/S



PR119FJ 1 1/16 x 2-7/8 **Primed FJ Solano/Colonial Casing** N/S
119FJ 1 1/16 x 2-7/8 **Unprimed FJ Colonial Casing** S



PR146FJ-2 1 1/16 x 2-1/4 **Primed FJ Classic Beaded Casing** N/S

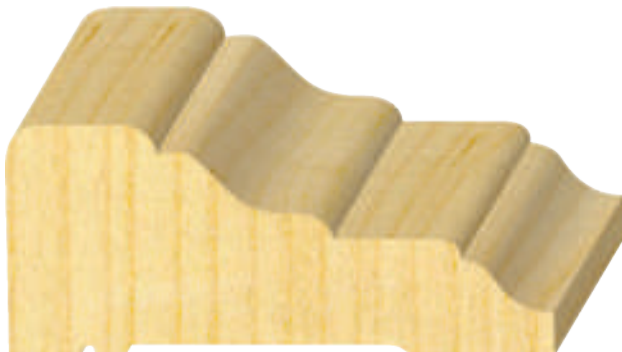

147FJ 1-3/16 x 2-7/8 **Unprimed FJ Palos Verdes Casing** S



PR165FJ 5/8 x 3 **Primed FJ #275 Casing** S
165FJ 5/8 x 3 **Unprimed FJ #275 Casing** S

3-3/16" to 3-1/4" Casing

(items are approximate scale only)

✦ Lengths available: 7' & 17' on profiles up to 2-1/4" wide only –
 17' if profile is wider than 2-1/4"  Mitered pairs available in 7'



PR148FJ 13/16 x 3-3/16 **Primed FJ Piedmont Casing** N



PR110FJ-3 5/8 x 3-1/4 **Primed FJ 3-Step Casing** N/S



126FJ 11/16 x 3-1/4 **Unprimed FJ Crescent Casing** S



PR129FJ 5/8 x 3-1/4 **Primed FJ Mission/Bel-Air Casing** N/S



PR133FJ 11/16 x 3-1/4 **Primed FJ Carolina Casing** N

PR133BFJ 11/16 x 3-9/16 **Primed FJ Palisade Casing** S

(items are approximate scale only)

3-1/4" Casing

✂ Lengths available: 7' & 17' on profiles up to 2-1/4" wide only – 17' if profile is wider than 2-1/4" **M** Mitered pairs available in 7'



PR135FJ 11/16 x 3-1/4 **Primed FJ Monterey/Colorado Casing** N/S



PR139FJ 9/16 x 3-1/4 **Primed FJ 2 Round Edge Casing** N/S



154FJ-3 1/2 x 3-1/4 **Unprimed FJ 3-Flute Casing (Not Reversible)** S

✂ lengths available: 14' & 16' + Trimbacks

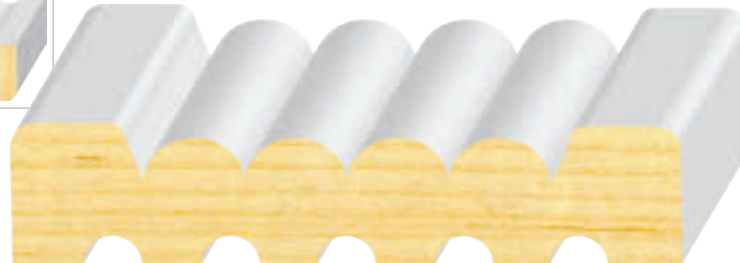

PR158FJ-3 11/16 x 3-1/4 **Primed FJ Reversible 5-Flute & Reed Casing** N



160FJ 1-1/4 x 3-1/4 **Unprimed FJ Hermosa Casing** S



3-1/4" Casing

(items are approximate scale only)

✂ Lengths available: 7' & 17' on profiles up to 2-1/4" wide only –
 17' if profile is wider than 2-1/4" Ⓜ Mitered pairs available in 7'



161FJ 5/8 x 3-1/4 **Unprimed FJ Cambridge Casing** S
 ✂ lengths available: 17' + Trimbacks



162FJ-3 11/16 x 3-1/4 **Unprimed FJ #366 Casing** S



PR170FJ 1 x 3-1/4 **Primed FJ Tudor Casing** S
170FJ 1 x 3-1/4 **Unprimed FJ Tudor Casing** S
 ✂ lengths available: 17' + Trimbacks



PR176FJ 5/8 x 3-1/4 **Primed FJ Moulded Casing** N/S
176FJ 5/8 x 3-1/4 **Unprimed FJ Moulded Casing** N



PR177FJ 1-1/16 x 3-1/4 **Primed FJ Howe Casing** N
PR177BFJ 11/16 x 3 **Primed FJ Howe Casing** S

(items are approximate scale only)

3-1/4" to 3-7/16" Casing

✂ Lengths available: 7' & 17' on profiles up to 2-1/4" wide only – 17' if profile is wider than 2-1/4"  Mitered pairs available in 7'



PR186FJ 1 x 3-1/4 **Primed FJ 49er Casing** **N**



PR166FJ 1-1/16 x 3-3/8 **Primed FJ Santa Fe/#275 Casing** **N/S**



PR146FJ-3 7/8 x 3-7/16 **Primed FJ Classic Beaded Casing** **N/S**



PR149FJ-3 7/8 x 3-7/16 **Primed FJ Meridian Casing** **N/S**

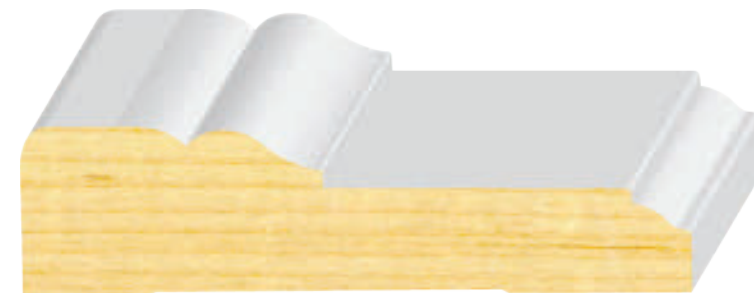

PR156FJ 5/8 x 3-7/16 **Primed FJ Shasta Casing** **N**

3-7/16" to 3-1/2" Casing

(items are approximate scale only)

✂ Lengths available: 7' & 17' on profiles up to 2-1/4" wide only –
 17' if profile is wider than 2-1/4"  Mitered pairs available in 7'



PR175FJ-3 11/16 x 3-7/16 **Primed FJ Sierra Casing** *N/S*



117FJ 9/16 x 3-1/2 **Unprimed FJ Colonial Base/Casing** *S*



138FJ 1 x 3-1/2 **Unprimed FJ Crescent Casing** *S*
 [FORMERLY 166A]

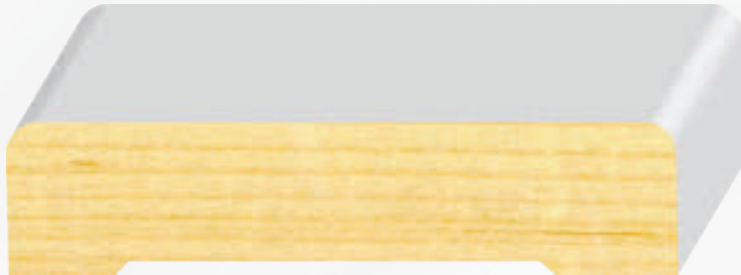

PR139BFJ 13/16 x 3-1/2 **Primed FJ 2 Round Edge Casing** *N/S*



155FJ 11/16 x 3-1/2 **Unprimed FJ Cape Cod Casing** *S*

(items are approximate scale only)

3-1/2" to 4" Casing

✂ Lengths available: 7' & 17' on profiles up to 2-1/4" wide only – 17' if profile is wider than 2-1/4" **M** Mitered pairs available in 7'



156FJ 11/16 x 3-1/2 **Unprimed FJ Chesapeake Casing** **S**

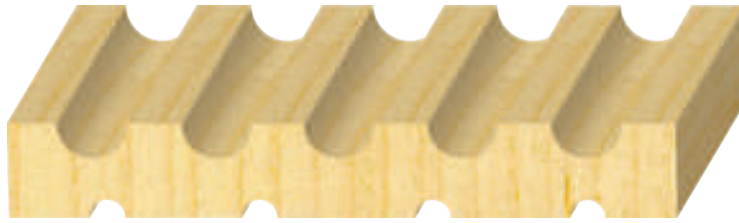

158FJ-3 1/2 x 3-1/2 **Unprimed FJ 5-Flute Casing (Not Reversible)** **S**

✂ lengths available: 16' + Trimbacks



PR172FJ-3 11/16 x 3-1/2 **Primed FJ Contemporary Casing** **N/S**



PR198FJ 11/16 x 3-1/2 **Primed FJ Valley Casing** **N**



PR199FJ 11/16 x 4 **Primed FJ 2 Eased Edge Craftsman Casing** **N/S**
[FORMERLY PR186A]



4-1/4" to 5-1/2" Casing

(items are approximate scale only)

✦ Lengths available: 7' & 17' on profiles up to 2-1/4" wide only –
 17' if profile is wider than 2-1/4" **M** Mitered pairs available in 7'



PR118FJ-4 9/16 x 4-1/4 **Primed FJ Colonial Base/Casing** **S**
PR362FJ-4 9/16 x 4-1/4 **Primed FJ Solano Base/Casing** **N**
118FJ-4 9/16 x 4-1/4 **Unprimed FJ Colonial Base/Casing** **S**



PR146FJ-4 7/8 x 4-1/4 **Primed FJ Classic Beaded Casing** **N/S**



PR136FJ 13/16 x 4-1/4 **Primed FJ Monterey/Colorado Casing** **N/S**



PR158FJ-4 11/16 x 4-1/4 **Primed FJ Reversible 6-Flute & Reed Casing** **N**



173FJ 1/2 x 5-1/2 **Unprimed FJ 4-Flute Casing** **S**
 ✦ lengths available: 16' + Trimbacks

Door Stop

lengths available: 7' & 17'

(items are approximate scale only)



PR201FJ 7/16 x 1-1/4
Primed FJ
1 Round Edge Stop N/S

201FJ 7/16 x 1-1/4
Unprimed FJ
1 Round Edge Stop N/S

202BFJ 3/8 x 1-1/4
Unprimed FJ
1 Round Edge Stop N



PR202FJ 3/8 x 1-1/4
Primed FJ 2RE Stop S

202FJ 3/8 x 1-1/4
Unprimed FJ 2RE Stop S



206FJ 1/2 x 1-1/4
Unprimed FJ 1RE Stop S



PR208FJ 7/16 x 1-1/4
Primed FJ Ogee Stop N



PR210FJ 1/2 x 1-3/4
Primed FJ
Ogee Stop S

210FJ 1/2 x 1-3/4
Unprimed FJ
Ogee Stop S



PR210BFJ 7/16 x 1-3/8
Primed FJ
Colonial Stop N

210BFJ 7/16 x 1-3/8
Unprimed FJ
Colonial Stop N



PR216FJ 7/16 x 1-3/8
Primed FJ 1RE Stop N

216FJ 7/16 x 1-3/8
Unprimed FJ 1RE Stop N



PR219FJ 7/16 x 1-3/8
Primed FJ Ogee Stop N



PR209FJ 1/2 x 1-1/2
Primed FJ 1RE Stop N/S

209FJ 1/2 x 1-1/2
Unprimed FJ 1RE Stop S



211FJ 1/2 x 1-1/2
Unprimed FJ Kerfed 1
Round Edge Stop w/Vinyl S
 lengths available: 7'



9023 7/16 x 1-3/8
Gray 3-Finger Vinyl
for Kerfed Stop S



PR213FJ 11/16 x 1-11/16
Primed FJ Howe Stop N
 lengths available: 7' & 17' only



212KFJ 1/2 x 2
Unprimed FJ Stop w/Kerf S

209KFJ 1/2 x 1-1/2
Unprimed FJ Stop w/Kerf S



220FJ 9/16 x 2-1/4
Unprimed FJ Garage Door Stop N
 lengths available: 16' only



3/4" to 2-1/4" Base & Base Shoe

lengths available: 16' + trimbacks – Flexible moulding available for all profiles

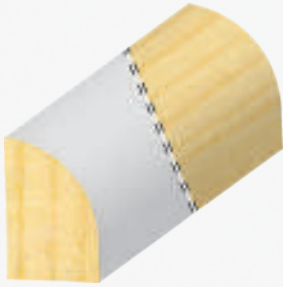

PR300AFJ 3/8 x 3/4
Primed FJ Base Shoe N/S
PR300ALVL **Primed FJ LVL Base Shoe** N/S
300AFJ 3/8 x 3/4 **Unprimed FJ Base Shoe** S

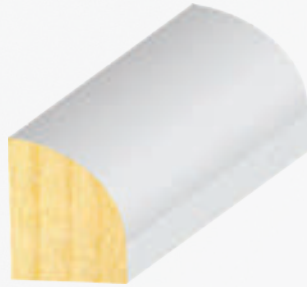

PR300BFJ 1/2 x 3/4
Primed FJ Base Shoe N/S
PR300BLVL **Primed LVL Base Shoe** N/S



301FJ 7/16 x 1-1/2
Unprimed FJ Flat Base/Apron N/S



PR304FJ 3/8 x 2-1/4
Primed FJ Streamline Base S
304FJ 3/8 x 2-1/4
Unprimed FJ Streamline Base S



PRR304FJ-2 3/8 x 2-1/4
Primed FJ Reversible Base N
PRR305FJ-2 1/2 x 2-1/4
Primed FJ Reversible Base N



PR306FJ 1/2 x 2-1/4
Primed FJ Streamline Base N



PR314FJ-2 7/16 x 2-1/4
Primed FJ Coronado Base N



PR305FJ 7/16 x 2-1/2
Primed FJ Streamline Base S
305FJ 7/16 x 2-1/2
Unprimed FJ Streamline Base S



PR310FJ 7/16 x 2-1/2
Primed FJ #711 Base S
310FJ 7/16 x 2-1/2
Unprimed FJ #711 Base S
310BFJ 5/8 x 2-1/2
Unprimed FJ #711 Base S

(items are approximate scale only)

2-1/2" to 3-1/4" Base

✂ lengths available: 16' + trimbacks – Flexible moulding available for all profiles



321FJ-2 7/16 x 2-1/2
Unprimed FJ 3-Step Base S
 [FORMERLY 312A]



319FJ 1/2 x 2-1/2
Unprimed FJ #356 Base S



PRR304FJ-3 3/8 x 3-1/4
Primed FJ Reversible Base N

PRR305FJ-3 1/2 x 3-1/4
Primed FJ Reversible Base N



PR320FJ 7/16 x 3-1/4
Primed FJ Colonial 356 Base N/S

320FJ 7/16 x 3-1/4
Unprimed FJ #356 Base S

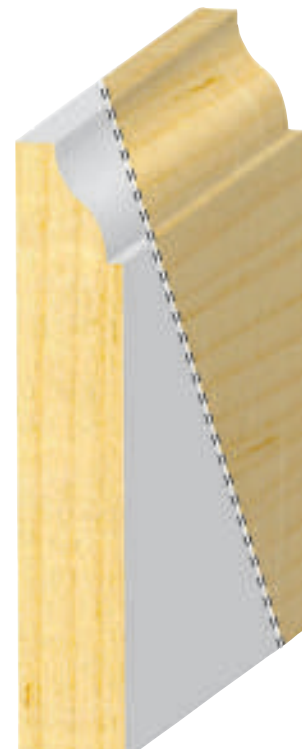

PR314FJ-3 9/16 x 3-1/4
Primed FJ Coronado/#623 Base N/S

314FJ-3 9/16 x 3-1/4
Unprimed FJ Coronado/#623 Base N/S

314FJ-3SC 1/2 x 3-3/16
Unprimed FJ Scant #623 Base S



3-1/4" to 3-7/16" Base

(items are approximate scale only)

✦ lengths available: 16' + trimbacks – Flexible moulding available for all profiles



PR344FJ-3 9/16 x 3-1/4
Primed FJ Peninsula Base N



PR347FJ-3 9/16 x 3-1/4
Primed FJ Edgewood Base N



PR356FJ-3 9/16 x 3-1/4
Primed FJ Riviera Base N



PR371FJ-3 9/16 x 3-1/4
Primed FJ Montecito Base N



PR338FJ-3 9/16 x 3-7/16
Primed FJ Santa Fe/#175 Base N/S



339FJ 9/16 x 3-7/16
Unprimed FJ Crescent Base S

(items are approximate scale only)

3-7/16" to 3-1/2" Base

✂ lengths available: 16' + trimbacks – Flexible moulding available for all profiles



PR358FJ 9/16 x 3-7/16
Primed FJ Classic Beaded Base **N/S**



PR365FJ-3 9/16 x 3-7/16
Primed FJ Crescent/Lancaster Base **N/S**



117FJ 9/16 x 3-1/2
Unprimed FJ Colonial Base/Casing **S**



PR118FJ-3 9/16 x 3-1/2
Primed FJ Colonial Base **S**



PR307FJ 7/16 x 3-1/2
Primed FJ Streamline Base **S**

307FJ 7/16 x 3-1/2
Unprimed FJ Streamline Base **S**



PR311FJ 7/16 x 3-1/2
Primed FJ #711 Base **S**

311FJ 7/16 x 3-1/2
Unprimed FJ #711 Base **S**



3-1/2" to 3-3/4" Base

(items are approximate scale only)

✦ lengths available: 16' + trimbacks – Flexible moulding available for all profiles



321FJ-3 1/2 x 3-1/2
Unprimed FJ
3 Step Base **S**



367FJ 1 x 3-1/2
Unprimed FJ
Palos Verdes Base **S**
[FORMERLY 327FJ]



PR387FJ-3 7/16 x 3-1/2
Primed FJ 1 Eased
Edge Craftsman Base **N/S**



324FJ 9/16 x 3-3/4
Unprimed FJ
Hermosa Base **S**

(items are approximate scale only)

4-1/4" Base

✂ lengths available: 16' + trimbacks – Flexible moulding available for all profiles

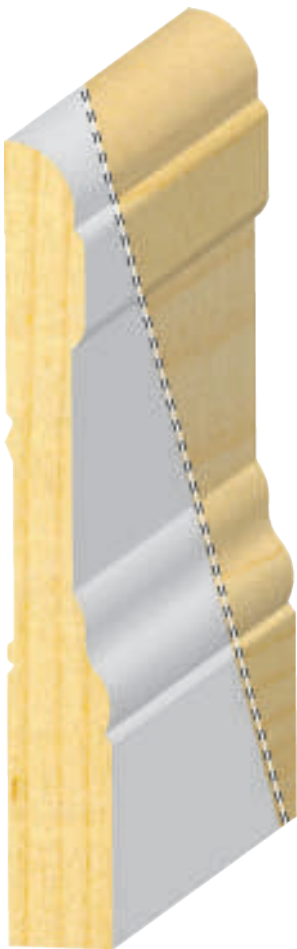

PR362FJ-4 9/16 x 4-1/4
Primed FJ
Solano Base N

PR118FJ-4 9/16 x 4-1/4
Primed FJ
Colonial Base S

118FJ-4 9/16 x 4-1/4
Unprimed FJ
Colonial Base S

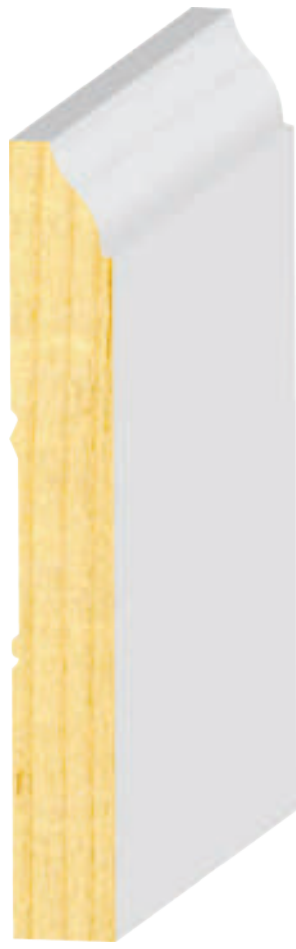

PR314FJ-4 9/16 x 4-1/4
Primed FJ
Coronado/#620 Base N/S

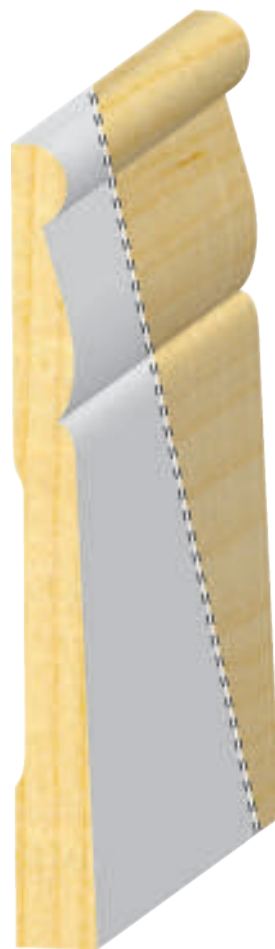

PR316FJ 7/16 x 4-1/4
Primed FJ
Monterey Base S

316FJ 7/16 x 4-1/4
Unprimed FJ
Monterey Base S



PR318BFJ-4 9/16 x 4-1/4
Primed FJ
Cape Cod Base N/S

318FJ-4 9/16 x 4
Unprimed FJ
Cape Cod Base S



4-1/4" Base

✂ lengths available: 16' + trimbacks – Flexible moulding available for all profiles

(items are approximate scale only)

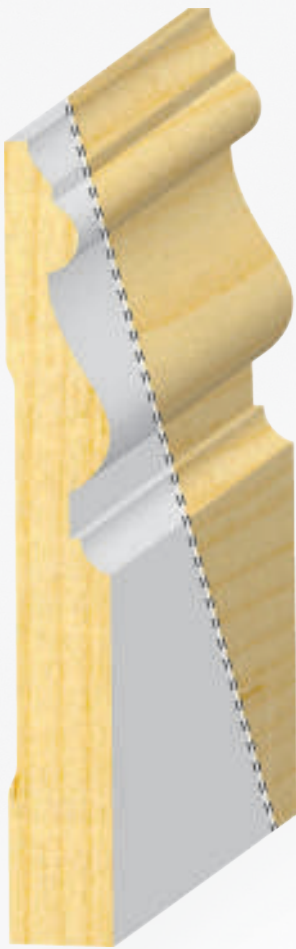

PR325FJ 9/16 x 4-1/4
Primed FJ
Imperial/#175 Base N/S

325FJ 9/16 x 4-1/4
Unprimed FJ
#175 Base S



326FJ 11/16 x 4-1/4
Unprimed FJ
Crescent Base S



PR371FJ-4 9/16 x 4-1/4
Primed FJ
Montecito Base N

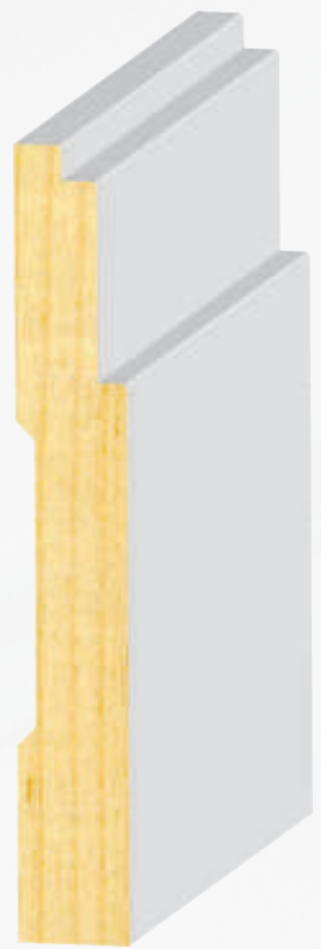

PR349FJ-4 9/16 x 4-1/4
Primed FJ
Meridian Base N/S

primed & unprimed fj pine | base



(items are approximate scale only)

4-1/2" Base

lengths available: 16' + trimbacks — Flexible moulding available for all profiles



321FJ-4 1/2 x 4-1/2
Unprimed FJ
3-Step Base **S**



PR338FJ-4 9/16 x 4-1/2
Primed FJ
Santa Fe/#175 Base **N/S**



PR380FJ 9/16 x 4-1/2
Primed FJ Carolina/
Palisade Base **N/S**

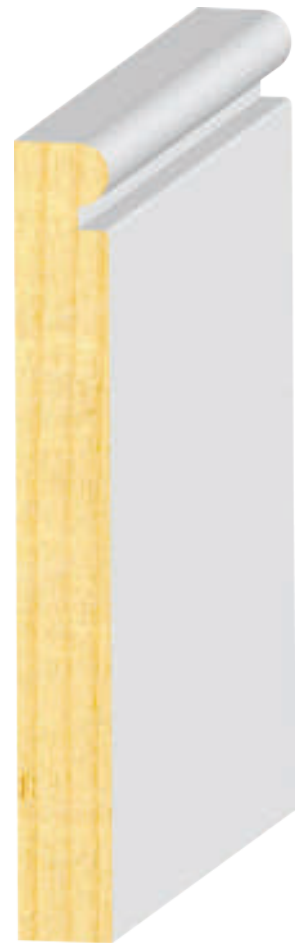

PR372FJ-4 9/16 x 4-1/4
Primed FJ
Contemporary Base **N/S**



5" to 5-1/4" Base

(items are approximate scale only)

✦ lengths available: 16' + trimbacks – Flexible moulding available for all profiles



PR323FJ 9/16 x 5
Primed FJ
Mission/Hermosa Base N/S

323FJ 9/16 x 5
Unprimed FJ
Hermosa Base S



PR336FJ 9/16 x 5
Primed FJ Sierra/
Montecito Base N/S



PR347FJ-5 9/16 x 5-3/16
Primed FJ
Edgewood Base N

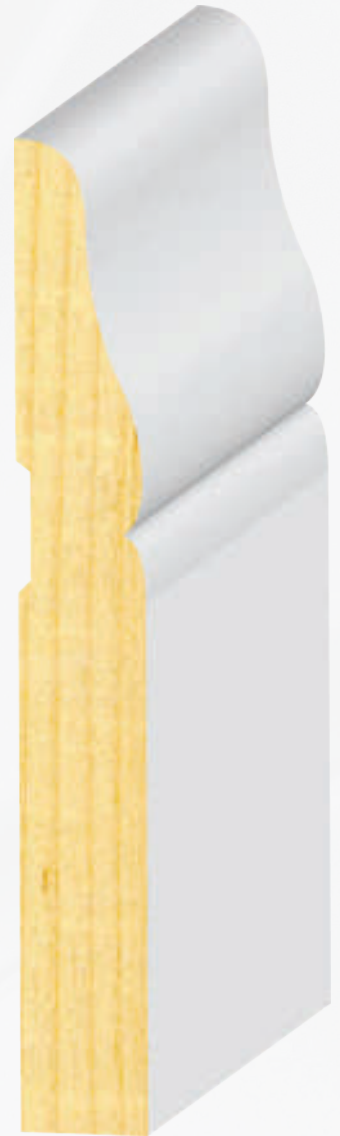

PR313FJ 11/16 x 5-1/4
Primed FJ
Classic Base N

(items are approximate scale only)

5-1/4" Base

✂ lengths available: 16' + trimbacks – Flexible moulding available for all profiles

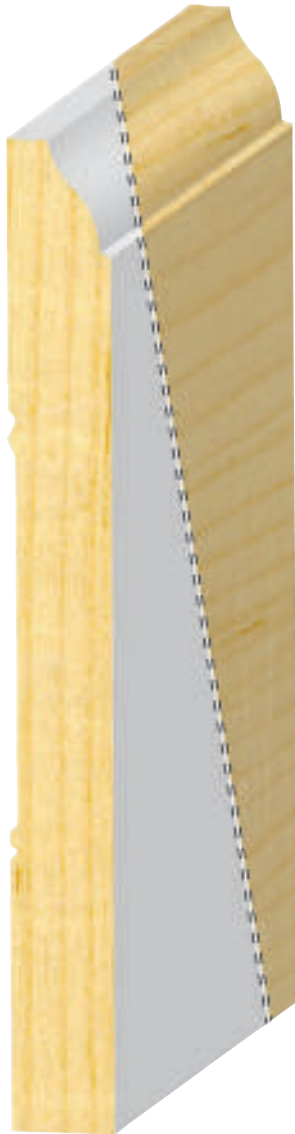

PR314FJ-5 9/16 x 5-1/4
Primed FJ
Coronado/#618 Base **N/S**

314FJ-5 9/16 x 5-1/4
Unprimed FJ #618 Base **S**



317FJ 9/16 x 5-1/4
Unprimed FJ
Crescent Base **S**



PR318FJ-5 9/16 x 5-1/4
Primed FJ
Cape Cod Base **N/S**

5-1/4" Base

(items are approximate scale only)

✦ lengths available: 16' + trimbacks – Flexible moulding available for all profiles



318BFJ 9/16 x 5-1/4
Unprimed FJ
"B" Cape Cod Base *S*



PR321FJ-5 1/2 x 5-1/4
Primed FJ
3-Step Base *N/S*

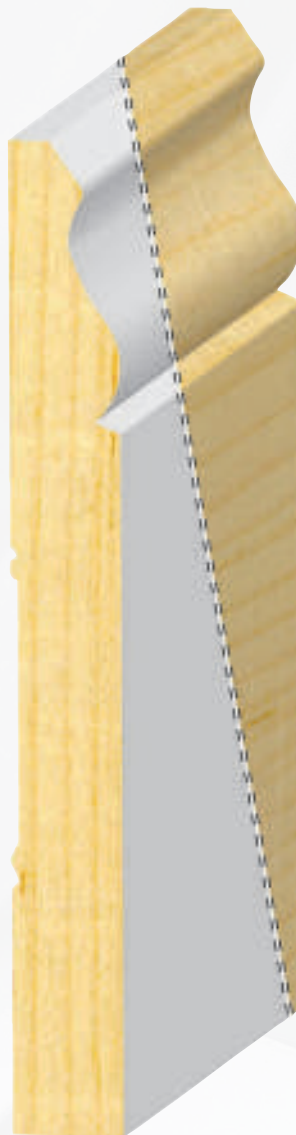

PR328FJ-5 9/16 x 5-1/4
Primed FJ
Vintage/Colonial
Base *N/S*

328FJ-5 9/16 x 5-1/4
Unprimed FJ
Colonial Base *S*



PR349FJ-5 9/16 x 5-1/4
Primed FJ
Meridian Base *N/S*



(items are approximate scale only)

5-1/4" Base

✂ lengths available: 16' + trimbacks – Flexible moulding available for all profiles

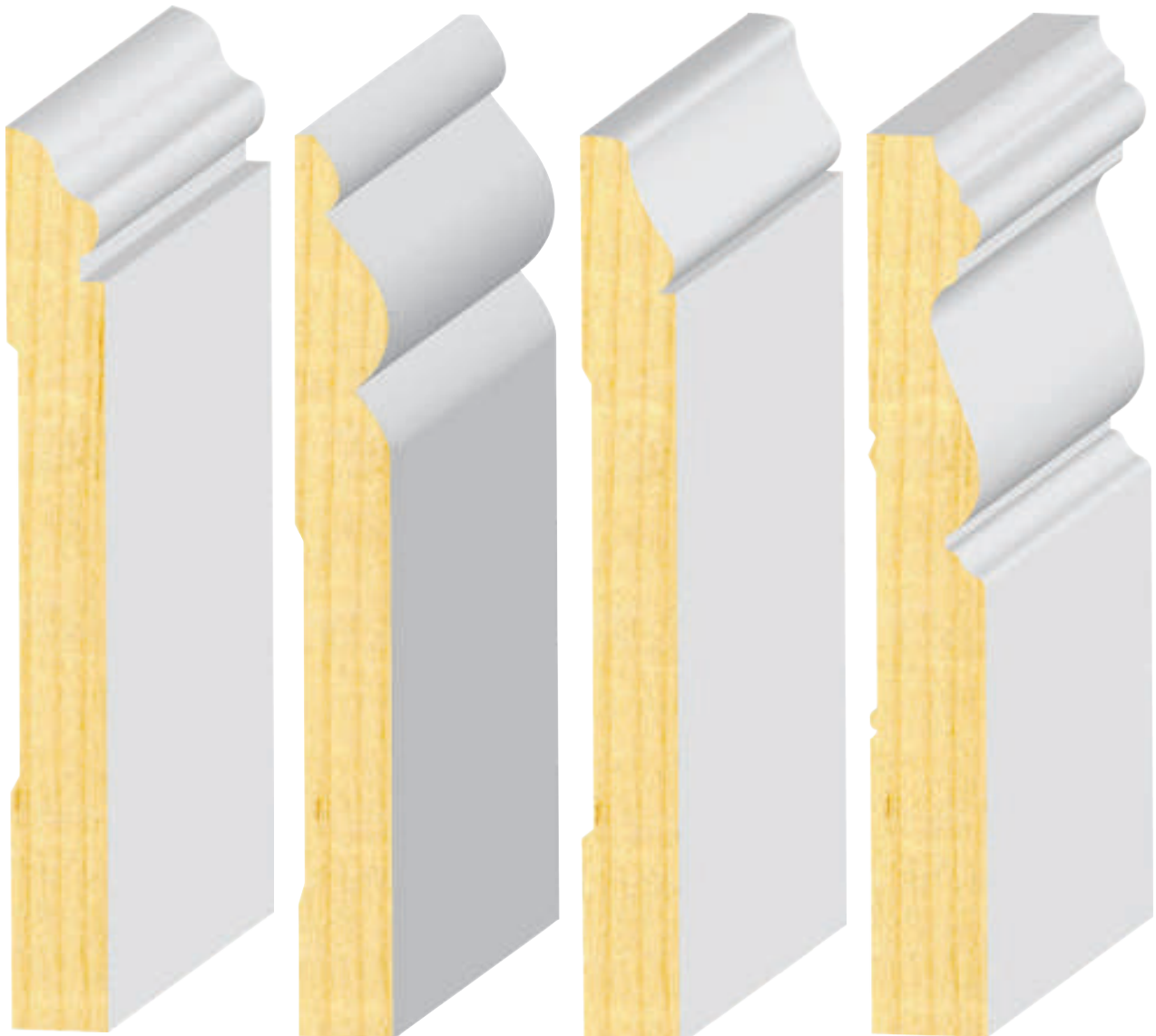

PR344FJ-5 9/16 x 5-1/4
Primed FJ
Peninsula Base **N**

PR352FJ 9/16 x 5-1/4
Primed FJ
Sierra Base **N**

PR356FJ-5 9/16 x 5-1/4
Primed FJ
Riviera Base **N**

PR361FJ-5 11/16 x 5-1/4
Primed FJ
Monterey/Sonoma Base **N/S**



5-1/4" Base

✦ lengths available: 16' + trimbacks – Flexible moulding available for all profiles

(items are approximate scale only)

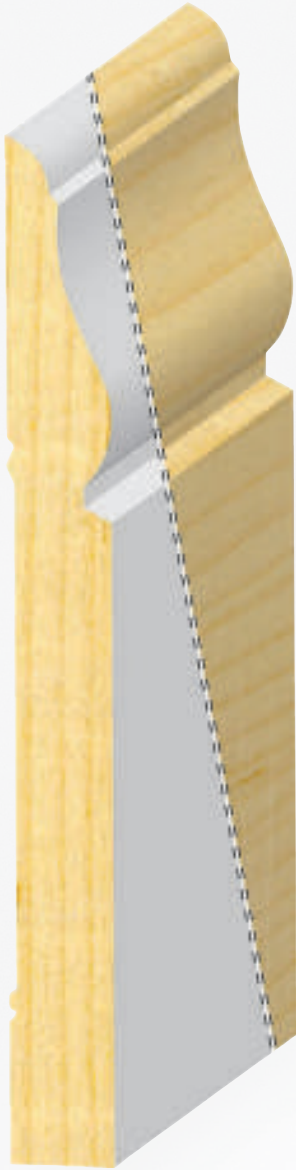

PR365FJ-5 5/8 x 5-1/4
Primed FJ
Crescent/Lancaster Base N/S

365FJ 5/8 x 5-1/4
Unprimed FJ Lancaster Base s



PR371FJ-5 9/16 x 5-1/4
Primed FJ
Montecito Base N



PR372FJ-5 9/16 x 5-1/4
Primed FJ
Contemporary Base N/S



(items are approximate scale only)

5-7/16" Base



PR384FJ 9/16 x 5-1/4
Primed FJ Howe Base **S**



PR338FJ-5 9/16 x 5-7/16
Primed FJ
Santa Fe/#175 Base **N/S**

338FJ-5 9/16 x 5-7/16
Unprimed FJ #175 Base **S**



PR359FJ 9/16 x 5-7/16
Primed FJ
Classic Beaded Base **N/S**



5-1/2" to 6" Base

(items are approximate scale only)

✦ lengths available: 16' + trimbacks – Flexible moulding available for all profiles



PR387FJ-5 1/2 x 5-1/2
**Primed FJ 1 Eased Edge
Craftsman Base** N/S



PR387FJ-6 5/8 x 6
**Primed FJ 1 Eased Edge
Craftsman Base** N/S
[FORMERLY PR383A]



PR385FJ 1/2 x 6
**Primed FJ
Carolina/Palisade Base** N/S



(items are approximate scale only)

7-1/4" Base

✂ lengths available: 16' + trimbacks — Flexible moulding available for all profiles

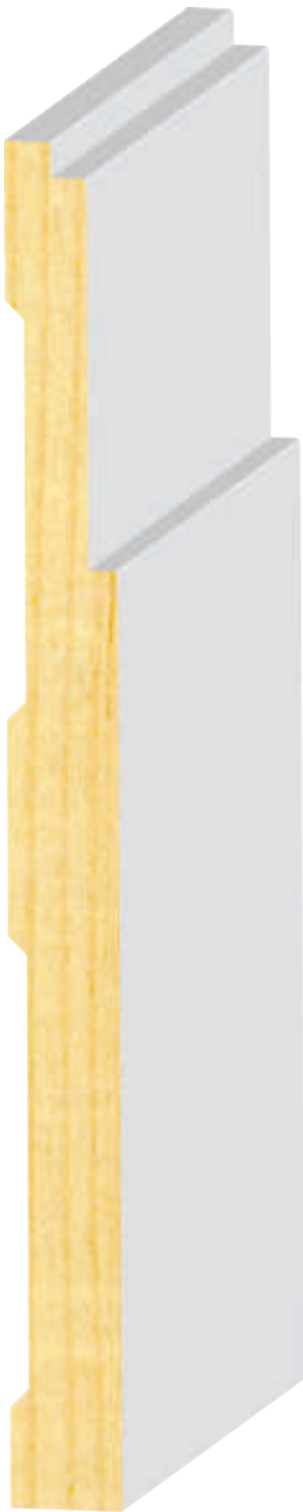

PR349FJ-7 5/8 x 7-1/4
Primed FJ
Meridian Base N/S



PR361FJ-7 11/16 x 7-1/4
Primed FJ
Monterey/Sonoma Base N/S



PR372FJ-7 9/16 x 7-1/4
Primed FJ
Contemporary Base N/S



1-5/8" to 2-3/4" Crown

(items are approximate scale only)

✂ lengths available: 16' + trimbacks – Flexible moulding available for all profiles



PR400FJ 9/16 x 1-5/8
Primed FJ Colonial Crown N/S



PR452FJ 1-7/16 x 1-3/4
Primed FJ Bed/Cabinet Crown N/S

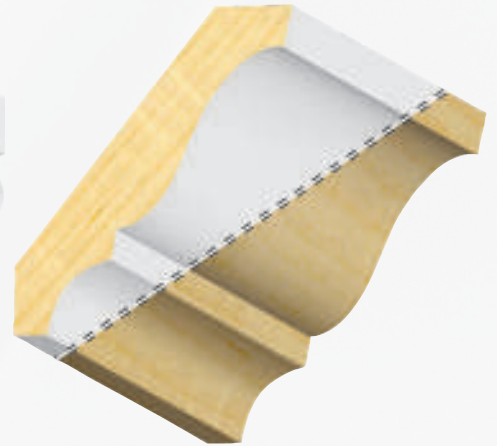

PR404FJ 9/16 x 2-1/4
Primed FJ Colonial Crown N/S
404FJ 9/16 x 2-1/4
Unprimed FJ Colonial Crown S

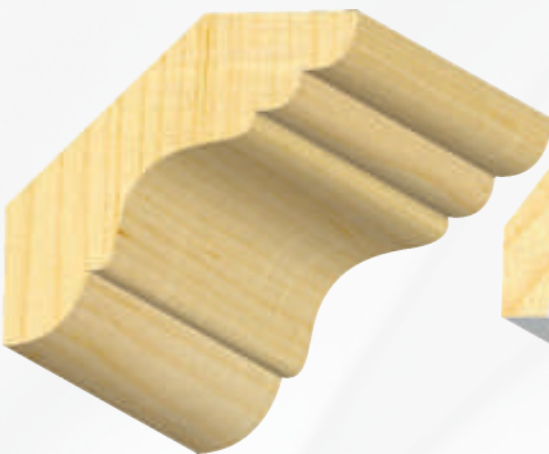

402FJ 11/16 x 2-1/2
Unprimed FJ Cornice S

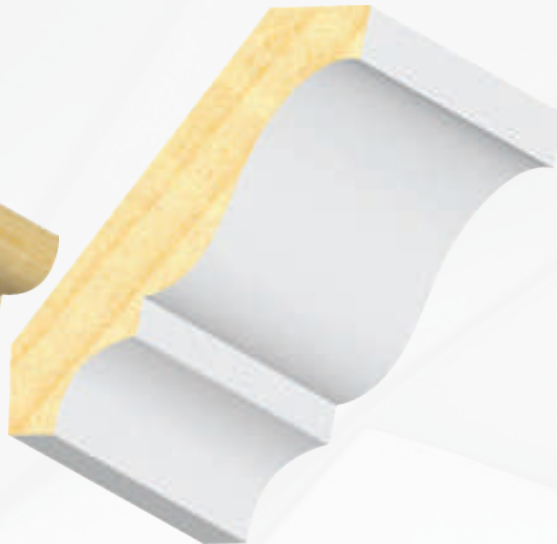

PR436FJ 9/16 x 2-3/4
Primed FJ Colonial Crown N

(items are approximate scale only)

3-1/8" to 3-3/8" Crown

✂ lengths available: 16' + trimbacks – Flexible moulding available for all profiles



PR453FJ 9/16 x 3-1/8
Primed FJ Edge Bead Crown N



413FJ 11/16 x 3-1/4
Unprimed FJ Cornice S

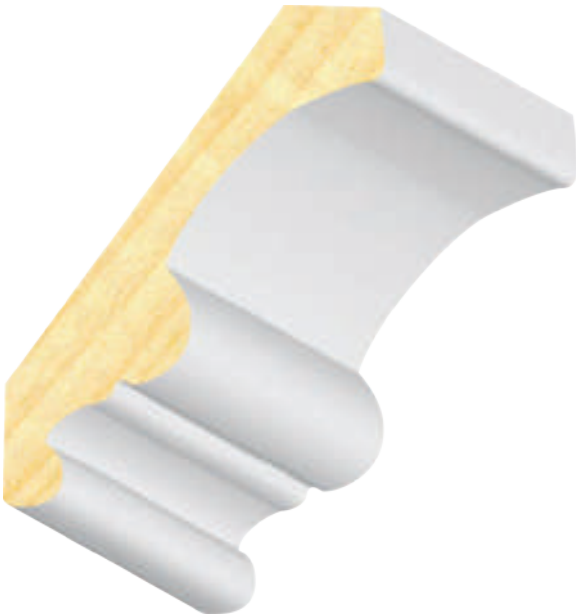

PR441FJ 11/16 x 3-1/4
Primed FJ Single Beaded Crown N

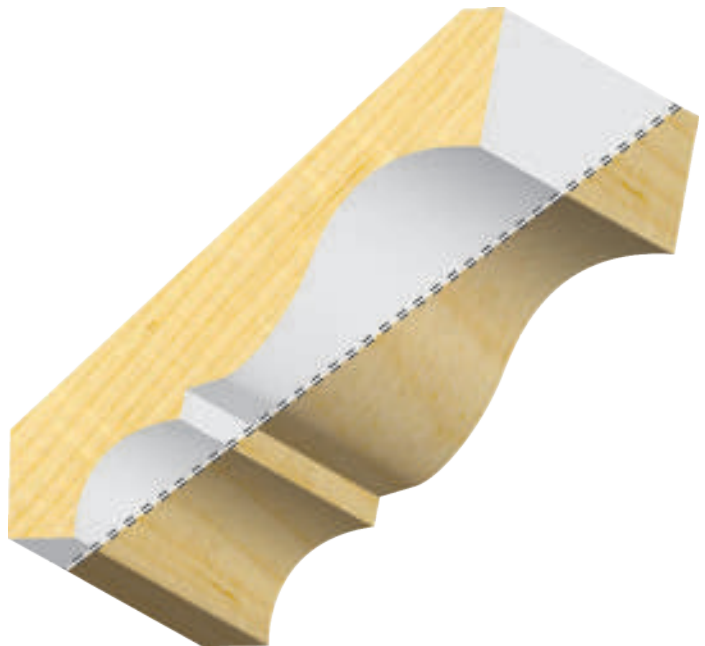

PR405FJ 9/16 x 3-3/8
Primed FJ Colonial Crown N/S

405FJ 9/16 x 3-3/8
Unprimed FJ Colonial Crown S

3-7/16" to 4-1/8" Crown

(items are approximate scale only)

✂ lengths available: 16' + trimbacks – Flexible moulding available for all profiles



PR421FJ 11/16 x 3-7/16
Primed FJ Double Bead Carolina Crown N/S

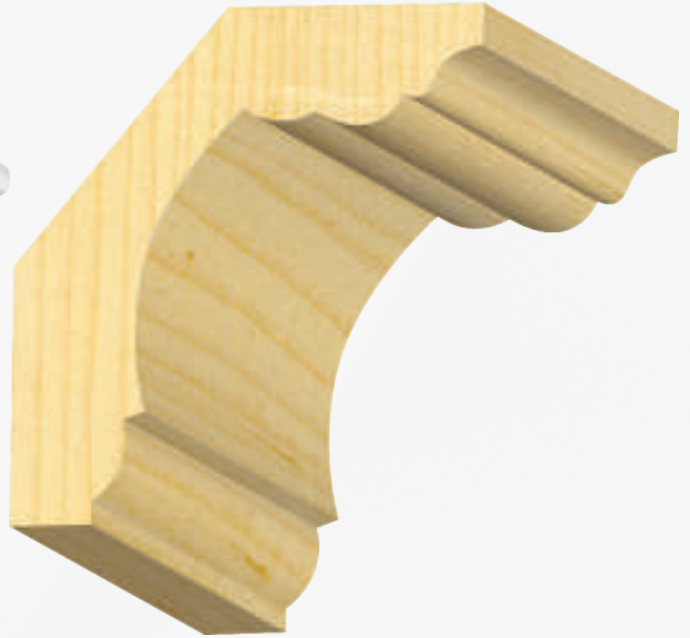

451FJ 1-1/4 x 3-9/16
Unprimed FJ Cornice S



PR448FJ-4 9/16 x 4-1/8
Primed FJ Cape Cod Crown N



(items are approximate scale only)

4-3/8" Crown

✂ lengths available: 16" + trimbacks – Flexible moulding available for all profiles

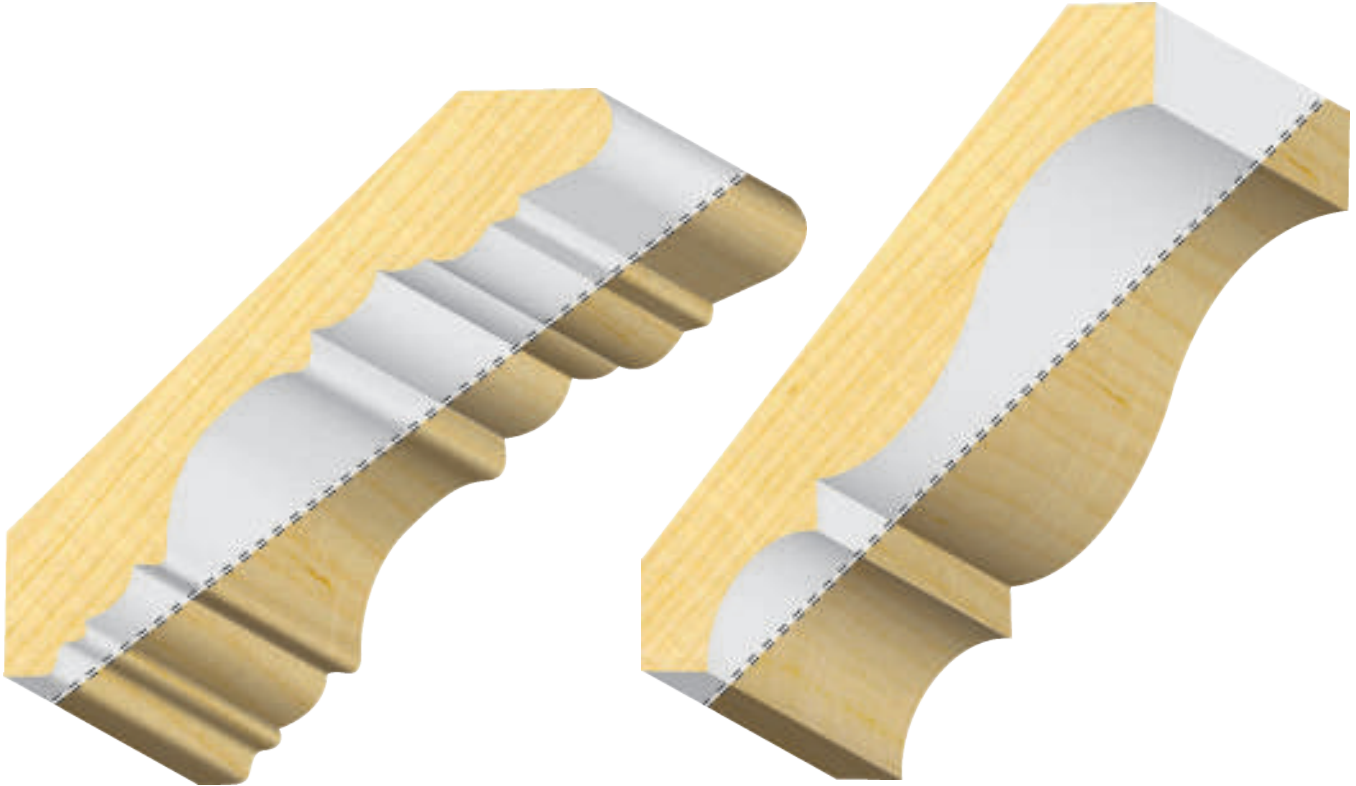

PR434FJ 5/8 x 4-3/8 **Primed FJ Coronado Crown** N
412FJ 11/16 x 4-1/4 **Unprimed FJ Georgian Crown** S

PR406FJ 9/16 x 4-3/8 **Primed FJ Colonial Crown** N/S
406FJ 9/16 x 4-3/8 **Unprimed FJ Colonial Crown** S



PR410FJ-4 5/8 x 4-3/8 **Primed FJ Small Charleston Crown** N/S

4-1/2" Crown

(items are approximate scale only)

✂ lengths available: 16' + trimbacks – Flexible moulding available for all profiles

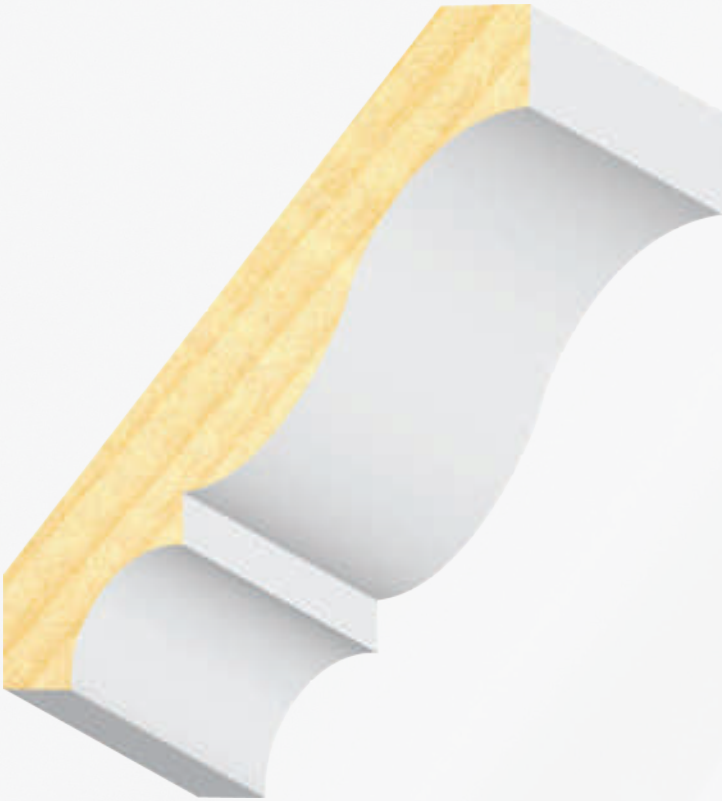

PR416FJ 11/16 x 4-1/2
Primed FJ Colonial Crown N

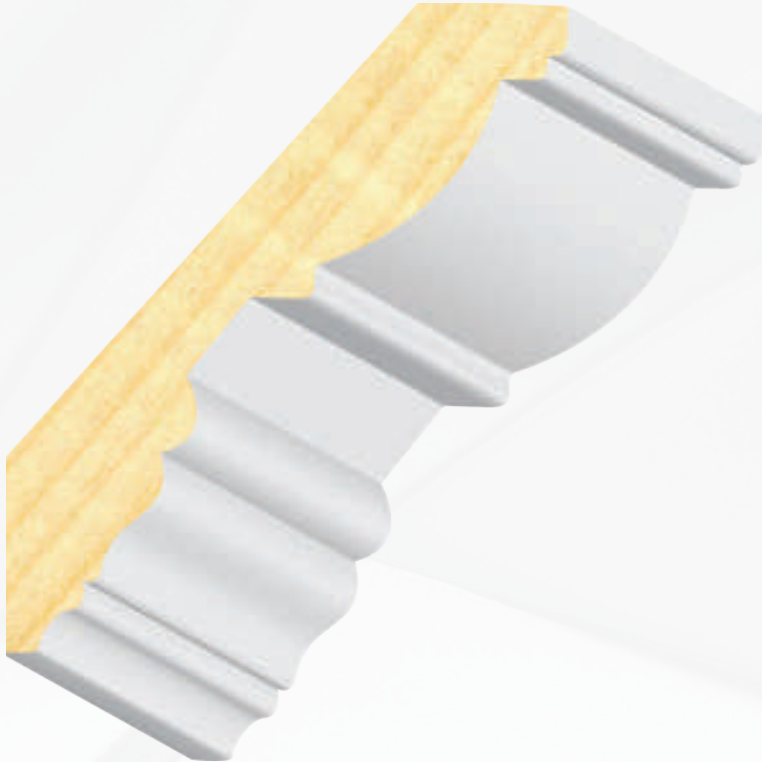

PR430FJ-4 11/16 x 4-1/2
Primed FJ Monterey Crown N/S



(items are approximate scale only)

4-1/2" to 4-5/8" Crown

✂ lengths available: 16' + trimbacks – Flexible moulding available for all profiles



PR407FJ 1-1/8 x 4-1/2
Primed FJ Cornice **N**

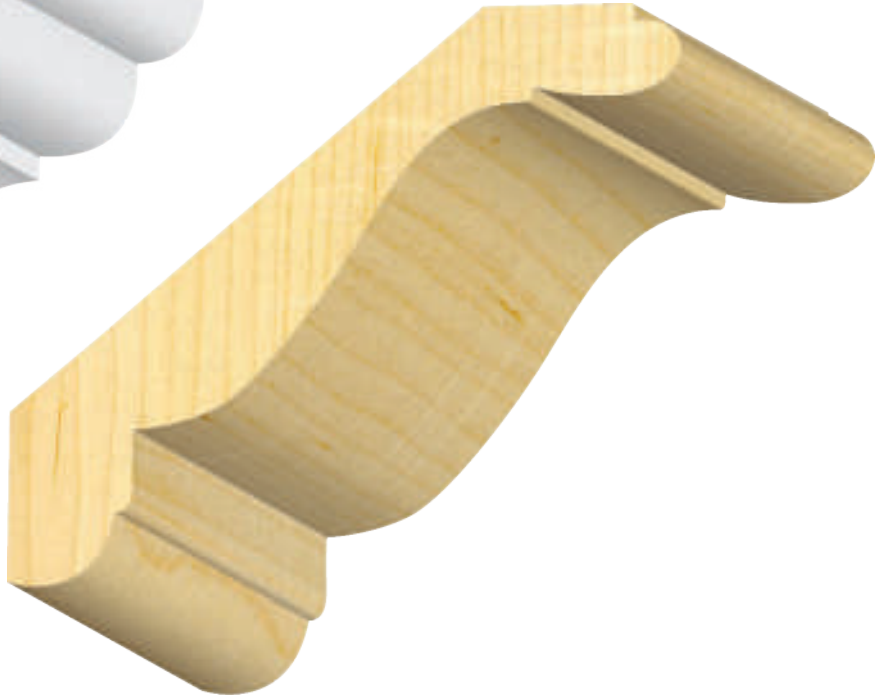

409FJ 11/16 x 4-5/8
Unprimed FJ Rancho Crown **S**

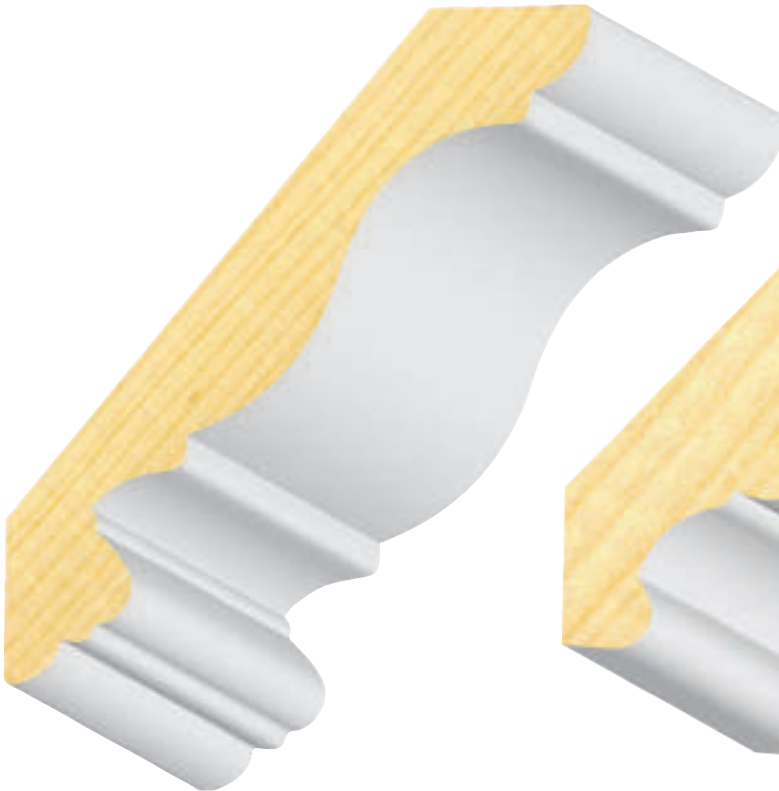

PR411FJ-4 11/16 x 4-5/8
Primed FJ Rafael Crown **N/S**

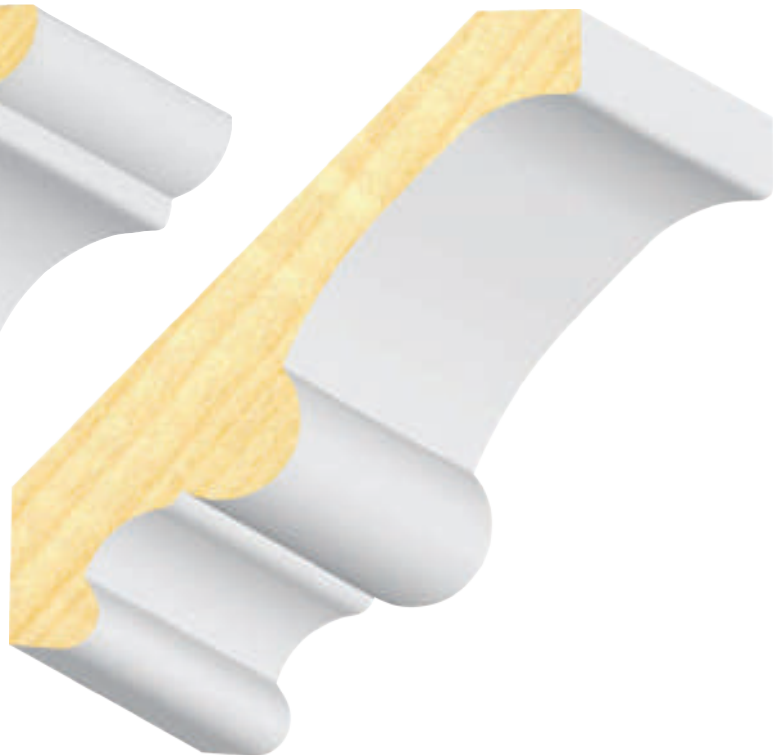

PR442FJ 11/16 x 4-5/8
Primed FJ Single Beaded Crown **N**



4-15/16" to 5" Crown

(items are approximate scale only)

✂ lengths available: 16' + trimbacks – Flexible moulding available for all profiles



PR423FJ 7/8 x 4-15/16
Primed FJ Double Bead Carolina Crown N/S



PR418FJ 5/8 x 5
Primed FJ Montecito Crown N/S

(items are approximate scale only)

5-1/4" Crown

✂ lengths available: 16' + trimbacks – Flexible moulding available for all profiles

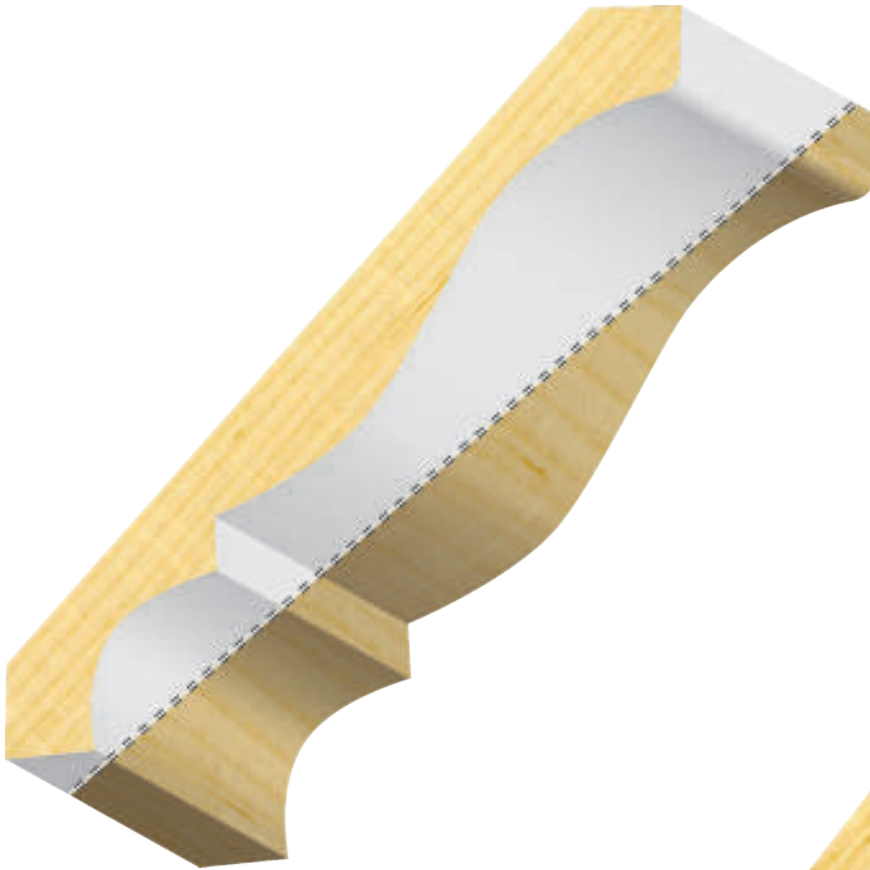

PR414FJ	9/16 x 5-1/4	Primed FJ Colonial Crown	N/S
PR415FJ	11/16 x 5-1/4	Primed FJ Colonial Crown	N
414FJ	9/16 x 5-1/4	Unprimed FJ Colonial Crown	S



PR448FJ-5 9/16 x 5-1/4 **Primed FJ Cape Cod Crown** **N**



5-1/4" Crown

(items are approximate scale only)

✂ lengths available: 16' + trimbacks – Flexible moulding available for all profiles



PR410FJ-5 11/16 x 5-1/4
Primed FJ Charleston Crown N/S



PR411FJ-5 11/16 x 5-1/4
Primed FJ Rafael Crown N/S



(items are approximate scale only)

5-1/4" Crown

✂ lengths available: 16' + trimbacks – Flexible moulding available for all profiles

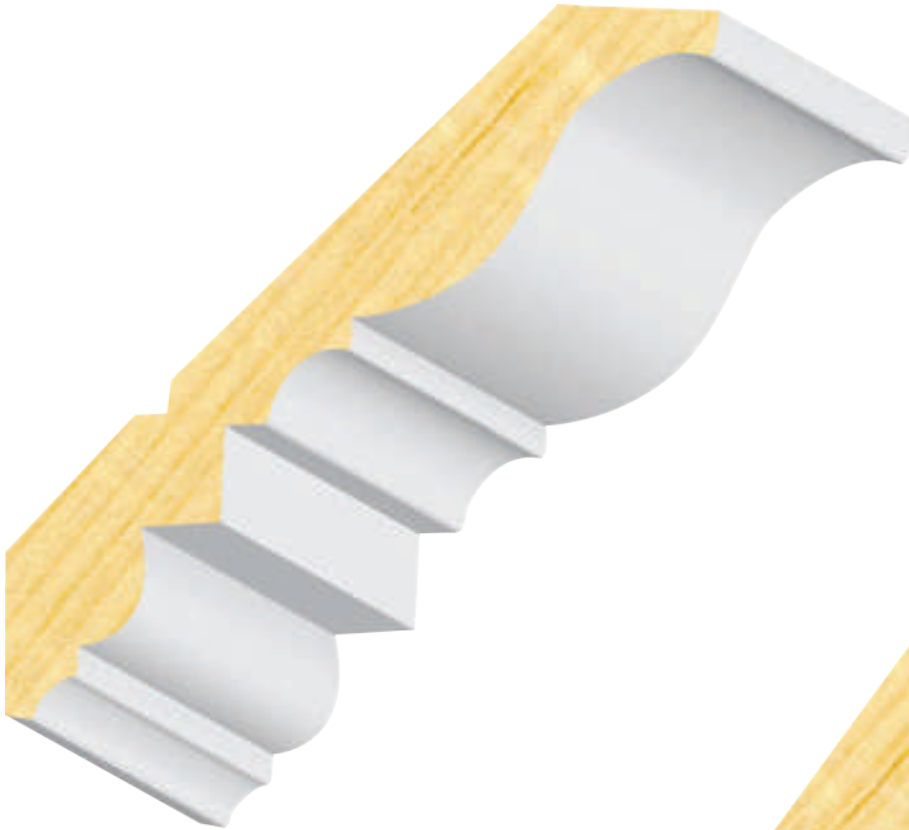

PR419FJ 11/16 x 5-1/4
Primed FJ Georgian Crown N/S



PR430FJ-5 11/16 x 5-1/4
Primed FJ Monterey Crown N/S



6" Crown

(items are approximate scale only)

✂ lengths available: 16' + trimbacks – Flexible moulding available for all profiles

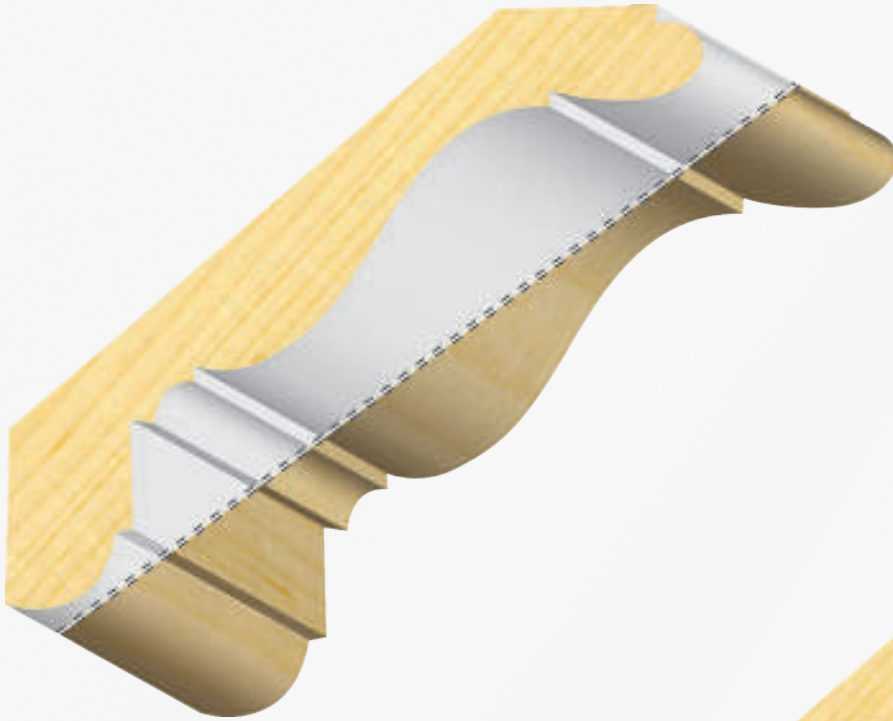

- PR408FJ** 1-1/4 x 6
Primed FJ Cornice N

- 408FJ** 1-1/4 x 5-3/4
Unprimed FJ Cornice S



- PR410FJ-6** 11/16 x 6
Primed FJ Charleston Crown N/S

- 410FJ-6** 5/8 x 6
Unprimed FJ Charleston Crown S



6-5/16" to 6-3/8" Crown

lengths available: 16' + trimbacks – Flexible moulding available for all profiles

(items are approximate scale only)



PR411FJ-6 1-1/16 x 6-5/16
Primed FJ Rafael Crown N/S

PR448FJ-6 11/16 x 6-3/8
Primed FJ Cape Cod Crown N



6-1/2" Crown

(items are approximate scale only)

✂ lengths available: 16' + trimbacks – Flexible moulding available for all profiles



PR430FJ-6 7/8 x 6-1/2
Primed FJ Monterey Crown N/S



(items are approximate scale only)

6-9/16" Crown

✦ lengths available: 16' + trimbacks – Flexible moulding available for all profiles



PR443FJ 7/8 x 6-9/16
Primed FJ Single Beaded Crown N

7-3/16" Crown

✂ lengths available: 16' + trimbacks – Flexible moulding available for all profiles

(items are approximate scale only)



PR424FJ-7 1-1/8 x 7-3/16
Primed FJ Double Bead Carolina Crown N/S



(items are approximate scale only)

7-1/4" Crown

✂ lengths available: 16' + trimbacks – Flexible moulding available for all profiles



PR417FJ 7/8 x 7-1/4
Primed FJ Colonial Crown N/S

Chair Rail

✂ lengths available: 16' + trimbacks

(items are approximate scale only)



PR657FJ 11/16 x 2-1/8
**Primed FJ
 Chair Rail** N

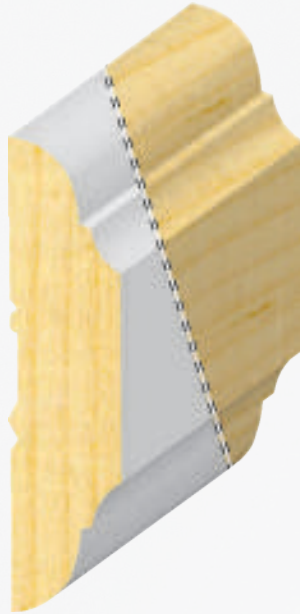

PR651FJ 9/16 x 2-1/2
**Primed FJ
 Chair Rail** N/S



PR655FJ 5/8 x 2-5/8
**Primed FJ
 Coronado Chair Rail** N

651FJ 9/16 x 2-1/2
**Unprimed FJ
 Chair Rail** S



PR671FJ 9/16 x 4-3/8
**Primed FJ
 Chair Rail Backer** S
 (with 3-1/4" Face)



649FJ 11/16 x 3
**Unprimed FJ
 Bead & Barrel
 Chair Rail** S



PR653FJ 11/16 x 3
**Primed FJ
 Chair Rail** N/S

653FJ 11/16 x 3
**Unprimed FJ
 Chair Rail** S



PR670FJ 9/16 x 3-1/2
**Primed FJ
 Chair Rail Backer** S
 (with 2-9/16" Face)



Cove / Quarter Round

✦ lengths available: 16'+ trimbacks

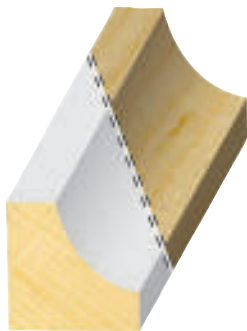

PR523FJ 11/16 x 11/16
Primed FJ Cove N/S
523FJ 11/16 x 11/16
Unprimed FJ Cove S



PR504FJ 11/16 x 11/16
Primed FJ Quarter Round N/S
504FJ 11/16 x 11/16
Unprimed FJ Quarter Round S

Full Round

✦ lengths available: 16'+ trimbacks



802FJ 1-1/4
Unprimed FJ Full Round N/S

Flat Astragal

✦ lengths available: 7', 8' & 16'



PR646FJ 11/16 x 1-5/8 **Primed FJ Flat Astragal/Panel Mold** N
PR660FJ 11/16 x 1-5/8 **Primed FJ Flat Astragal/Panel Mold** S
660FJ 11/16 x 1-5/8 **Unprimed FJ Flat Astragal/Panel Mold** S

T-Astragal

✦ lengths available: 7' and 8'



662FJ 1-1/4 x 2
Unprimed FJ T-Astragal N/S
[for 1-3/8" Door]



661FJ 1-1/4 x 2-1/4
Unprimed FJ T-Astragal S
 ✦ lengths available: 7' & 8'
[for 1-3/4" Door]

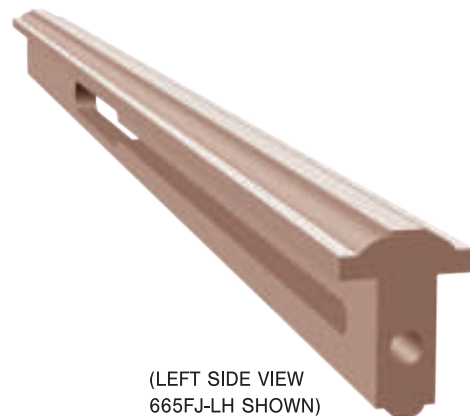

(LEFT SIDE VIEW
 665FJ-LH SHOWN)

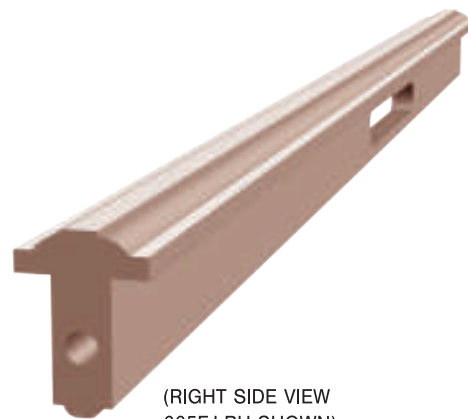

(RIGHT SIDE VIEW
 665FJ-RH SHOWN)

665FJ-LH 1-1/2 x 2 (indicate LH) FACES ACTIVE DOOR
665FJ-RH 1-1/2 x 2 (indicate RH) FACES ACTIVE DOOR
Unprimed FJ T-Astragal S
 ✦ lengths available: 8' only
[for 1-3/8" Door]



Panel Mold

✦ lengths available: 16' + trimbacks

(items are approximate scale only)



PR600FJ 9/16 x 3/4
Primed FJ Panel Mold N/S

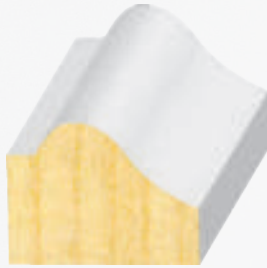

PR602FJ 3/4 x 1
Primed FJ Panel Mold N/S



PR609FJ 7/16 x 1-1/8
Primed FJ Panel Mold N/S



PR603FJ 11/16 x 1-3/8
Primed FJ Panel Mold N/S



PR601FJ 9/16 x 1-1/2
Primed FJ Panel Mold N



PR604FJ 11/16 x 1-3/4
Primed FJ Panel Mold N/S



PR605FJ 11/16 x 1-5/8
Primed FJ Panel Mold S

605FJ 11/16 x 1-5/8
Unprimed FJ Panel Mold S

(items are approximate scale only)

Panel Mold & Cap

lengths available: 16' + trimbacks



PR614FJ 11/16 x 1-3/8
Primed FJ Coronado Base/Panel Cap N/S



620FJ 3/4 x 1-1/2
Unprimed FJ Panel Cap S
[with 3/8" Rab't]



PR626FJ 1-3/16 x 1-3/8
Primed FJ Panel Cap N/S
[with 1/4 x 3/4 Rabbet]



PR625FJ 11/16 x 2
Primed FJ Large Cap N
[with 3/16 x 1-3/8 Rabbet]

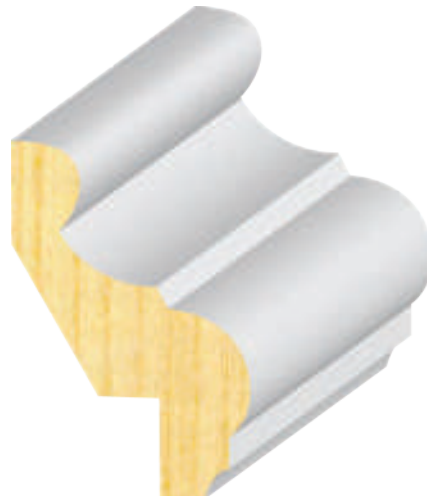

PR621FJ 3/4 x 2
Primed FJ T&G Wainscot Cap S
[with 3/4" Rab't]



PR620BFJ 11/16 x 2-1/8
Primed FJ Coronado Wainscot Cap N/S
[with 3/8 x 5/8 Rab't]



Panel Mold

✦ lengths available: 16' + trimbacks

(items are approximate scale only)



PR613FJ 1-3/16 x 2-3/16
Primed FJ Raised Panel Cap N/S
[with 5/16 x 11/16 Rab't]



PR627FJ 11/16 x 2-3/8
Primed FJ Colonial Cap N/S



PR628FJ 11/16 x 2-7/16
Primed FJ Victorian Cap N/S



PR740FJ 1 x 2-1/2
Primed FJ Contemporary Panel Cap N/S
[with 5/8" Rab't]



PR623FJ 1-9/16 x 2-5/8
Primed FJ Craftsman Cap N/S
[with 3/4" Rab't]

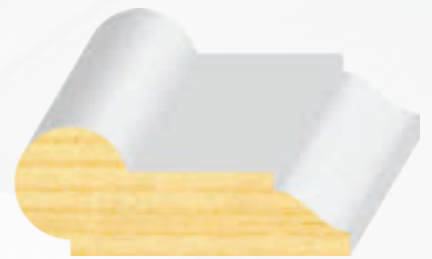

PR916FJ 11/16 x 1-3/4
Primed FJ Picture Mold N/S

(items are approximate scale only)

Apron

✦ lengths available: 16" + trimbacks



301FJ 7/16 x 1-1/2
Unprimed FJ Flat Base/Apron N/S



902FJ 3/8 x 1-1/2
Unprimed FJ Apron S
 Other options for apron are casing or base underneath a window stool.



PR904FJ 5/8 x 2-1/4
Primed FJ Apron N/S



PR996FJ 1-1/16 x 2 **Primed FJ Window Stool** N

Window Stool



980FJ 11/16 x 4-3/4 **Unprimed FJ Flat Stool** S
979FJ 11/16 x 5-1/2 **Unprimed FJ Flat Stool** S
985FJ 11/16 x 7-1/4 **Unprimed FJ Flat Stool** S



PR990FJ 11/16 x 4-1/2 **Primed FJ Ogee Window Stool** N
990FJ 11/16 x 4-1/2 **Unprimed FJ Ogee Window Stool** N
PR992FJ 11/16 x 5-1/4 **Primed FJ Ogee Window Stool** N
992FJ 11/16 x 5-1/4 **Unprimed FJ Ogee Window Stool** N
993FJ 11/16 x 6-1/2 **Unprimed FJ Ogee Window Stool** N
PR994FJ 11/16 x 7-1/4 **Primed FJ Ogee Window Stool** N
994FJ 11/16 x 7-1/4 **Unprimed FJ Ogee Window Stool** N

Hook & Cleat

(items are approximate scale only)



10FJ 9/16 x 1-1/2
Unprimed FJ
1 Eased Edge Cleat N/S



15FJ 9/16 x 3-1/4 **Unprimed FJ 1 Eased Edge Hookstrip** N/S



16FJ 11/16 x 4-1/2
Unprimed FJ Hookstrip N
[with 5/16 x 3/4" Rab't]

Nosing

✦ lengths available: 16' + trimbacks

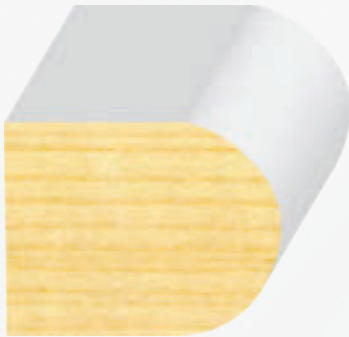

PR913FJ 1-1/8 x 1-7/16 **Primed FJ Nosing** N

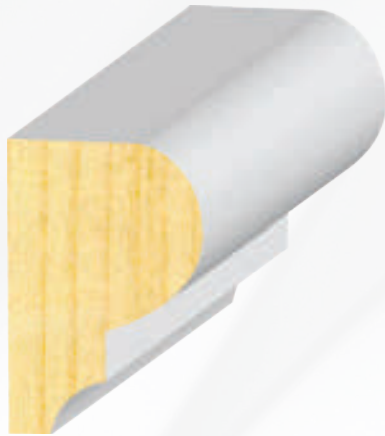

PR909FJ 1-1/4 x 1-3/4 **Primed FJ Nose & Cove** N

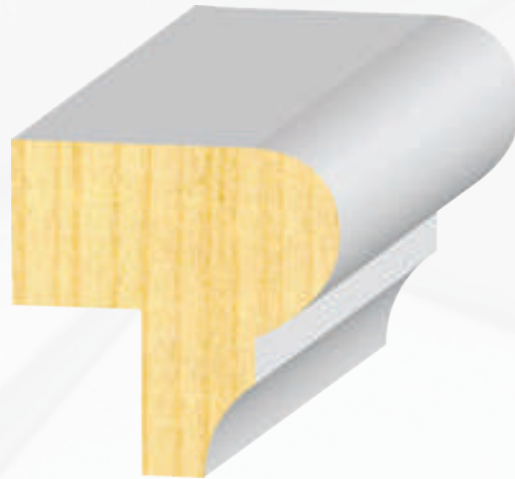

PR910FJ 1-3/4 x 1-3/4 **Primed FJ Nose & Cove** N
[with 11/16" x 11/16" Rab't]

PR910BFJ 1-3/4 x 1-3/4 **Primed FJ Nose & Cove** N
[with 11/16" x 7/8" Rab't]



(items are approximate scale only)

Exterior Brick & Stucco Mold

✂ lengths available: 7', 17'+ trimbacks



PR953FJ 3/4 x 1-1/4
Primed FJ Stucco Mold S

953FJ 3/4 x 1-1/4
Unprimed FJ Stucco Mold S



954FJ 7/8 x 1-3/16
Unprimed FJ Flat Stucco Mold S

(Perfect for nailing 1x trim around a door or window when stucco is used)



PR833FJ 13/16 x 1-1/2
Primed FJ Stucco N

PR833BFJ 11/16 x 1-1/2
Primed FJ Thin Stucco N

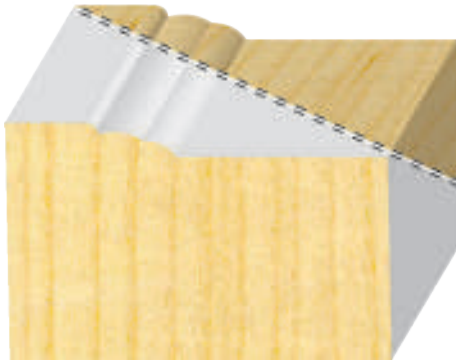

PR612AFJ 1-1/4 x 2
Primed FJ #180 Eastern Brick Mold N/S
without Stucco Key

612AFJ 1-1/4 x 2
Unprimed FJ #180 Eastern Brick Mold N/S
without Stucco Key



PR612BFJ 1-1/4 x 2
Primed FJ #180 Eastern Brick Mold N/S
with Stucco Key

612BFJ 1-1/4 x 2
Unprimed FJ #180 Eastern Brick Mold N/S
with Stucco Key



636FJ-1 11/16 x 1-5/8
Unprimed FJ Arizona Brick Mold S



636FJ-2 11/16 x 2-1/4
Unprimed FJ Arizona Brick Mold S



S4S

(NO WARRANTY PROVIDED ON EXTERIOR USE)

(items are approximate scale only)

UNTREATED S1S/S4S BOARDS

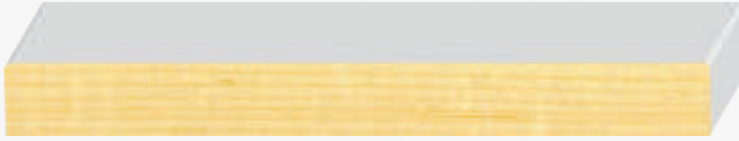

Unprimed S4S

(NO WARRANTY PROVIDED ON EXTERIOR USE)

715FJ (1x4)	11/16 x 3-1/2	Unprimed FJ S4S	S
750FJ (1x6)	11/16 x 5-1/2	Unprimed FJ S4S	S
751FJ (1x8)	11/16 x 7-1/4	Unprimed FJ S4S	S
753FJ (1x12)	11/16 x 11-1/4	Unprimed FJ S4S	S

Primed S4S

(NON-PROTECTED)

(NO WARRANTY PROVIDED ON EXTERIOR USE)

PR713FJ (1x2)	11/16 x 1-1/2	Double Primed FJ S4S	S
PR715FJ (1x4)	11/16 x 3-1/2	Double Primed FJ S4S	S
PR750FJ (1x6)	11/16 x 5-1/2	Double Primed FJ S4S	S
PR751FJ (1x8)	11/16 x 7-1/4	Double Primed FJ S4S	S
PR753FJ (1x12)	11/16 x 11-1/4	Double Primed FJ S4S	S

16'

1x2S4S (1x2)	3/4 x 1-1/2	Primed FJ S4SSE	N/S
1x3S4S (1x3)	3/4 x 2-1/2	Primed FJ S4SSE	N/S
1x4S4S (1x4)	3/4 x 3-1/2	Primed FJ S4SSE	N/S
1x6S4S (1x6)	3/4 x 5-1/2	Primed FJ S4SSE	N/S
1x8S4S (1x8)	3/4 x 7-1/4	Primed FJ S4SSE	N/S
1x10S4S (1x10)	3/4 x 9-1/4	Primed FJ S4SSE	N/S
1x12S4S (1x12)	3/4 x 11-1/4	Primed FJ S4SSE	N/S
5/4x4S4S (5/4x4)	1-1/16 x 3-1/2	Primed FJ S4SSE	N
5/4x6S4S (5/4x6)	1-1/16 x 5-1/2	Primed FJ S4SSE	N
5/4x8S4S (5/4x8)	1-1/16 x 7-1/4	Primed FJ S4SSE	N

Primed S1S

(1 SIDE SMOOTH / 1 SIDE ROUGH HEWN)

(NO WARRANTY PROVIDED ON EXTERIOR USE)

PR760FJ 1x2	23/32 x 1-1/2	Primed FJ S1S2E	N/S
PR761FJ 1x3	23/32 x 2-1/2	Primed FJ S1S2E	N/S
PR762FJ 1x4	23/32 x 3-1/2	Primed FJ S1S2E	N/S
PR763FJ 1x6	23/32 x 5-1/2	Primed FJ S1S2E	N/S
PR764FJ 1x8	23/32 x 7-1/4	Primed FJ S1S2E	N/S
PR765FJ 1x10	23/32 x 9-1/4	Primed FJ S1S2E	N/S
PR766FJ 1x12	23/32 x 11-1/4	Primed FJ S1S2E	N/S
PR767FJ 5/4x4	1-1/8 x 3-1/2	Primed FJ S1S2E	N/S
PR768FJ 5/4x6	1-1/8 x 5-1/2	Primed FJ S1S2E	N/S
PR769FJ 5/4x8	1-1/8 x 7-1/4	Primed FJ S1S2E	N/S
PR770FJ 2x2	1-7/16 x 1-1/2	Primed FJ S1S2E	N/S
PR771FJ 2x4	1-7/16 x 3-1/2	Primed FJ S1S2E	N/S
PR772FJ 2x6	1-7/16 x 5-1/2	Primed FJ S1S2E	N/S
PR773FJ 2x8	1-7/16 x 7-1/4	Primed FJ S1S2E	N/S
PR774FJ 2x10	1-7/16 x 9-1/4	Primed FJ S1S2E	N/S
PR775FJ 2x12	1-7/16 x 11-1/4	Primed FJ S1S2E	N/S

FOR TREATED PRIMED FJ BOARDS, PLEASE REFER TO BODYGUARD TRIMBOARDS & SIDINGS SECTION.

Wainscot

lengths available: 16' + trimbacks

(items are approximate scale only)



PR2000FJ 3/8 x 3-7/8 **Primed FJ Beaded T&G Wainscot** N/S
2000FJ 3/8 x 3-3/8 **Unprimed FJ Beaded T&G Wainscot** S



PR734FJ 3/4 x 2-5/16 **Primed FJ Wainscot Cap** N
 (with 1/4" x 1" Rab't)
 (use with PR2000FJ and PR2001FJ)



PR2001FJ 3/8 x 3-1/4 **Primed FJ Flat T&G Wainscot** N/S
2001FJ 3/8 x 3-1/4 **Unprimed FJ Flat T&G Wainscot** S



PR2004FJ 1/2 x 3-5/16
Primed FJ Reversible Beaded V-Groove T&G Wainscot N

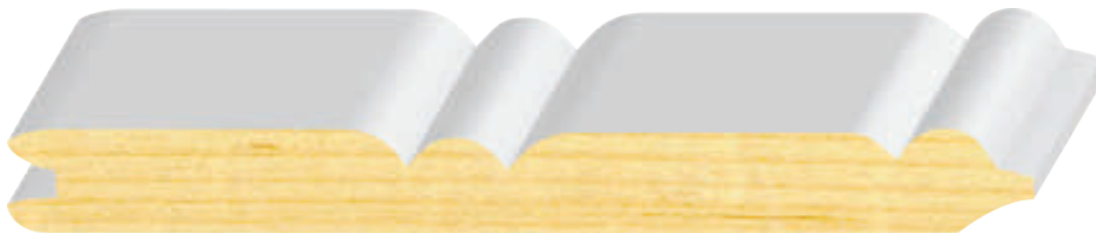

PR2002FJ 9/16 x 5-3/8 **Primed FJ Beaded T&G Wainscot** S



PR2003FJ 3/4 x 5-3/8 **Primed FJ Flat V-Groove T&G Ceiling Panel** N/S



PR2007FJ 5/8 x 5-1/2 **Primed FJ Reversible V-Groove/Nickel Gap T&G** N/S (1 SIDE NICKEL GAP / 1 SIDE V-GROOVE)



Wainscot

(items are approximate scale only)

✂ lengths available: 16' + trimbacks



PR2008FJ 5/8 x 7-1/8 **Primed FJ Reversible V-Groove/Nickel Gap T&G Wainscot** *N/S* (1 SIDE V-GROOVE / 1 SIDE NICKEL GAP)

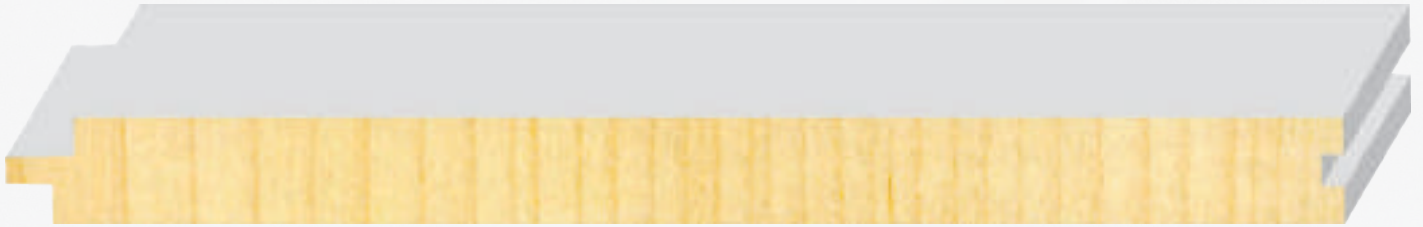

PR2009FJ 5/8 x 7-1/8 **Primed FJ Reversible Single/Double Nickel Gap T&G Wainscot** *N/S*

Exterior Double Rabetted Door Frames

✂ lengths available: all 6' thru 16'

Rabbeted 1/2" x 1-7/16"
(1-3/8" DOOR)

Rabbeted 1/2" x 1-13/16"
(1-3/4" DOOR)

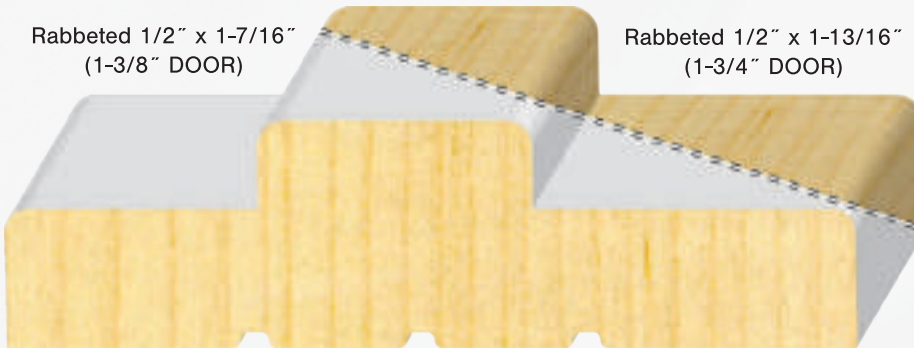

Accepts 1-3/8" Doors **OR** 1-3/4" Doors

EXTERIOR DOUBLE RABETTED FJ FRAMES

		Raw or Primed FJ Pine		
	SIZE	6/8	8/0	17' LINEAL
<i>N/S</i>	4-5/8	458DR6 PR458DR6	—	458DRL PR458DRL
<i>N/S</i>	5-1/4	514DR6 PR514DR6	—	514DRL PR514DRL
<i>N/S</i>	6-5/8	658DR6 PR658DR6	PR658DR8	658DRL PR658DRL
<i>N/S</i>	7-1/4	PR714DR6	PR714DR8	PR714DRL



(items are approximate scale only)

Standard Exterior Door Frames

lengths available: all 6' thru 16'

EXTERIOR DOOR FRAMES							
Standard for 1/2" x 1-13/16" Door Rab't.							
	Unprimed FJ			Primed FJ			
	SIZE	6/8	8/0	17' LINEAL	6/8	8/0	17' LINEAL
N/S	4-1/8	4186	4188	418L	PR4186	PR4188	PR418L
S	4-1/2	4126	4128	412L	PR4126	PR4128	PR412L
S	4-5/8	4586	4588	458L	PR4586 N	PR4588 N	PR458L N
S	4-3/4	434E6	434E8	434EL	PR434E6	PR434E8	PR434EL
N/S	5-1/4	514E6	514E8	514EL	PR514E6	PR514E8	PR514EL
S	6-1/8	6186	6188	618L	PR6186	PR6188	PR618L
N/S	6-5/8	6586	6588	658L	PR6586	PR6588	PR658L
N/S	7-1/4	714E6	714E8	714EL	PR714E6	PR714E8	PR714EL

Rabbeted 1/2" x 1-13/16"
(1-3/4" DOOR)



Exterior Door Frame Specs

- ☞ 1-1/4" Thick
- ☞ 6/8 = 82-1/2" Below Dado
- ☞ 8/0 = 98-1/2" Below Dado
- ☞ No Screen Rabbet
- ☞ Single End Dado (Except on Lineal)
- ☞ 3 Pair Per Bundle
- ☞ Kerfing for Bullnose is Available
- ☞ Custom Widths Available
- ☞ FR in part no. denotes 20 Minute Fire Rating

Rabbeted 1/2" x 2-1/8"
(1-3/4" DOOR)



Weatherstrip Kerfed Exterior Door Frames

lengths available: all 6' thru 16'

EXTERIOR DOOR FRAMES									
Weatherstrip Kerfed with 1/2" x 2-1/8" Rab't.									
		Unprimed FJ			Primed FJ			Frame Saver	
	SIZE	6/8	8/0	17' LINEAL	6/8	8/0	17' LINEAL	6/8	8/0
N/S	4-1/8	418W6 N/A	418W8 N/A	418WL N/A	PR418W6 PR418W6D	PR418W8 PR418W8D	PR418WL N/A	-	-
N/S	🔥	N/A	N/A	N/A	FRPR418W6	FRPR418W8	N/A		
S	4-1/2	412W6	412W8	412WL	N/A	N/A	N/A	FS4916W6	FS4916W8
N/S	4-5/8	458W6	458W8	458WL	PR458W6 PR458W6D	PR458W8 PR458W8D	PR458WL	-	-
N/S	🔥	FR458WS N	FR458W8S N	N/A	FRPR458W6	FRPR458W8	N/A	-	-
S	4-3/4	434W6	434W8	434WL	PR434W6	PR434W8	PR434WL	FS4916W6	FS4916W8
N/S	5-1/4	514EW6	514W8	514WL	PR514W6 PR514W6D	PR514W8 PR514W8D	PR514WL	FS514W6	FS514W8
N/S	🔥	N/A	N/A	N/A	FRPR514WS	FRPR514W8S	N/A	-	-
S	5-1/2	512W6	512W8	N/A	N/A	N/A	N/A	-	-
S	6-1/8	618W6	618W8	618WL	PR618W6	PR618W8	PR618WL	-	-
N	6-5/8	658W6	658W8	658WL	PR658W6 PR658W6D	PR658W8 PR658W8D	PR658WL	FS6916W6	FS6916W8
N/S	7-1/4	714EW6	714W8	714WL	PR714W6	PR714W8	PR714WL	FS714W6	FS714W8
N/S	🔥	FR714WS N	N/A	N/A	FRPR714WS	FRPR714W8S	N/A	-	-
S	7-1/2	712W6	712W8	712WL	N/A	N/A	N/A	-	-

Exterior Door Frame Specs

- ☞ 1-1/4" Thick
- ☞ 6/8 = 82-1/2" Below Dado
- ☞ 8/0 = 98-1/2" Below Dado
- ☞ No Screen Rabbet
- ☞ Single End Dado (Except on Lineal)
- ☞ 3 Pair Per Bundle
- ☞ Kerfing for Bullnose is Available
- ☞ Custom Widths Available
- ☞ FR in Part No. denotes 20 Minute Fire Rating
- ☞ 'D' at the end of part number denotes "Made in America"



Frame Saver
Primed FJ Door Frames with 4" rot proof wood composite on the bottom of each leg to prevent water absorption. (see p.351)

Interior Door Jambs

(items are approximate scale only)

lengths available: all 6' thru 16'



Kerfing for bullnose is available on all jamb sizes and species and custom size odd wall widths available upon request.

INTERIOR DOOR JAMBS				
Raw or Primed (PR) FJ Pine				
	SIZE	6/8	8/0	17' LINEAL
N/S	3-9/16	391616 PR391616	391618 PR391618	39161L PR39161L S
N/S	3-9/16	391616K2S PR391616K2S	391618K2S PR391618K2S	- -
N/S	4-9/16	491616 PR491616	491618 PR491618	49161L PR49161L
N/S	4-3/4	43416 PR43416	43418 PR43418	4341L PR4341L
S	4-7/8	47816	47818	4781L
N/S	5-1/4	51416 PR51416	51418 PR51418	5141L PR5141L
S	5-1/2	51216	51218	-
N/S	6-9/16	691616 PR691616	691618 PR691618	69161L PR69161L
N/S	7-1/4	71416 PR71416	71418 PR71418	7141L PR7141L
S	7-1/2	71216	71218	-
N/S	11-1/4	111416	111418	-

Interior Door Jamb Specs

NOR CAL, CENTRAL CAL, AZ

- ☞ 11/16" Thick
- ☞ 6/8 = 81" Below Dado
- ☞ 8/0 = 97" Below Dado
- ☞ Lineal - 17' = MDF, FJ Pine & Oak Veneer
- ☞ Random Lengths only available in most Solid Wood Species
- ☞ Dado depth is 3/8"
- ☞ Heads cut 3/4 over opening
- ☞ 5 pair per bundle

SO CAL, NV

- ☞ 11/16" Thick
- ☞ 6/8 = 80-5/8" Below Dado
- ☞ 8/0 = 96-5/8" Below Dado
- ☞ Lineal - 17' = MDF, FJ Pine & Oak Veneer
- ☞ Random Lengths only available in most Solid Wood Species
- ☞ Dado depth is 3/8"
- ☞ Heads cut 3/4 over opening
- ☞ 5 pair per bundle

PRIMED DOMESTIC INTERIOR DOOR JAMBS				
Raw FJ Pine - 1-1/4" THICK				
	SIZE	6/8	8/0	17' LINEAL
N/S	3-9/16	PR391616D	PR391618D	-
N/S	4-9/16	PR491616D	PR491618D	-
N/S	4-3/4	PR43416D	PR43418D	-
N/S	5-1/4	PR51416D	PR51418D	-
N/S	6-9/16	PR691616D	PR691618D	-
N/S	7-1/4	PR71416D	PR71418D	-

SAN DIEGO S4S (NO RAB'T)				
Raw FJ Pine - 1-1/4" THICK				
	SIZE	6/8	8/0	17' LINEAL
N/S	4-1/8	418SD6	418SD8	418SDL
N/S	4-1/2	412SD6	412SD8	412SDL
N/S	4-3/4	434SD6	434SD8	434SDL
N/S	5-1/4	514SD6	514SD8	514SDL
N/S	6-1/8	618SD6	618SD8	618SDL
N/S	7-1/4	714SD6	714SD8	714SDL

1-1/4" THICK JAMBS
(NO RAB'T)



Big Ideas



Big Ideas

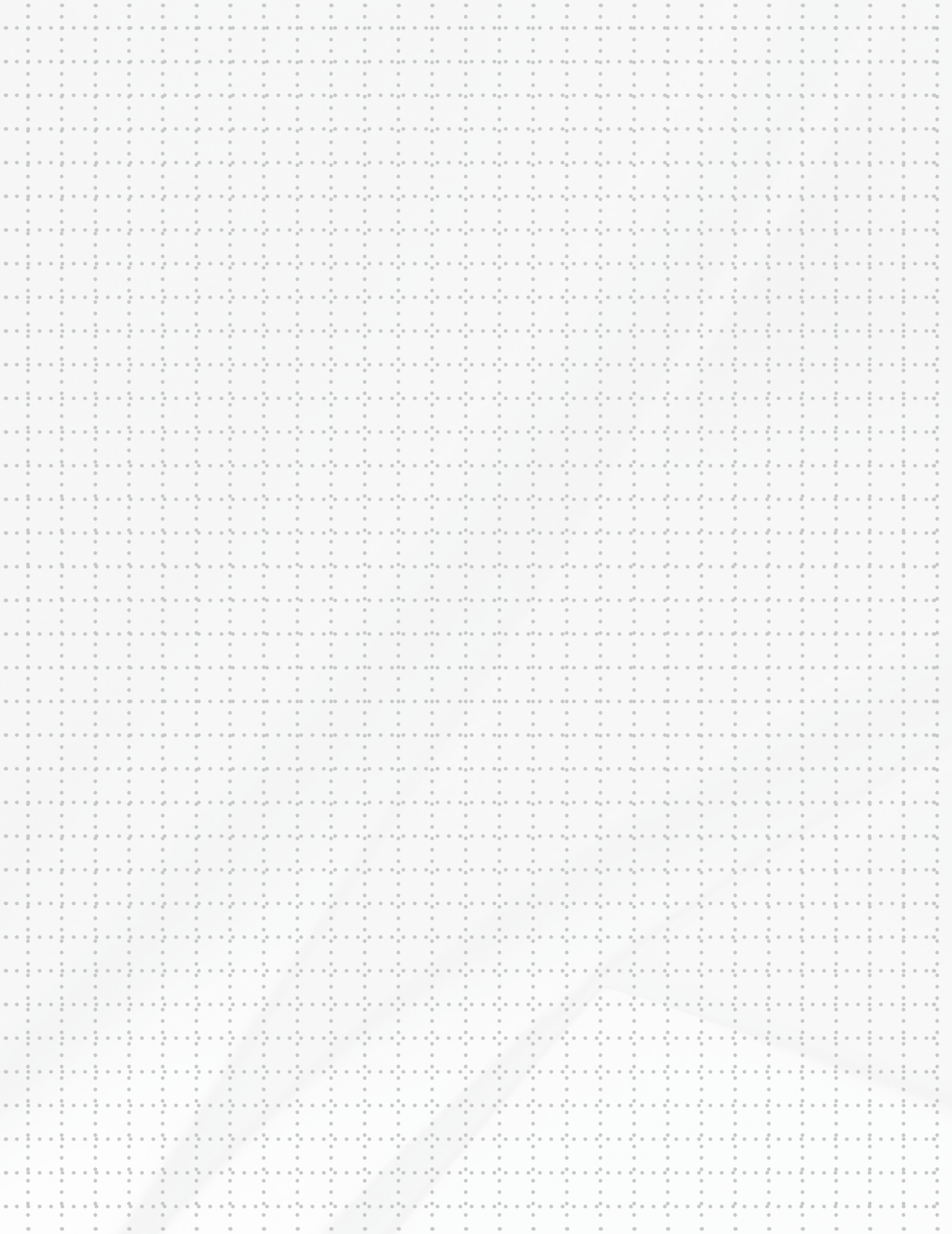

Ultralight (MUL) & Light Density (LDF) MDF

FOR PAINTGRADE ARCHITECTURAL MILLWORK



With costs less than Finger Joint Pine, Ultralight (MUL) and Light Density (LDF) MDF are pre-primed, have no joints, will not crack, split, twist or warp and never have raised or inconsistent grain. MUL and LDF are available in long lengths with no trimbacks. MDF has become the moulding of choice, for multi-million dollar homes, entry to high-end tract housing and commercial spaces, to create unique spaces while reducing millwork costs.

section contents

Base	201
Casing.....	185
Crown Mold.....	226
Chair Rail.....	249
Cleat.....	252
Door Stop.....	200
Flat Astragal/Panel Mold.....	250
Header	200
Hook.....	252
Interior Door Jambs	255
MDF Shelving	254
Panel Cap.....	250
Pediment Crown.....	225
S4S.....	253
Wainscotting & Wainscot Base	251
Wall Cap	253
Window Stool.....	252

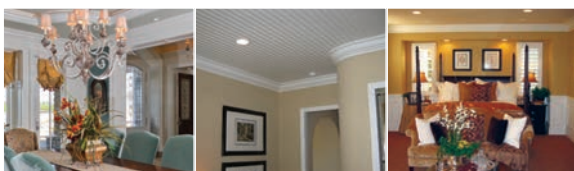

Ultralight & LDF MDF

I

DESIGN STYLES

**JANKA
HARDNESS**
(POUNDS-FORCE)

1000-1500

CUT LIST

TRADITIONAL | COASTAL | CONTEMPORARY | COUNTRY FRENCH

Determining How Much You Need

- 1 Measure the room at the height or length where each moulding goes to determine the number and the length of the pieces you'll need.
- 2 MDF casing and stop is available in 7' on select profiles, 17' on all casing profiles and 16' or 17' on door stop. When figuring how much footage your project requires, for each type of moulding, base, casing, crown, etc., measure your walls or openings and add the footage. Then multiply the footage by 1.1. The result is the total footage needed plus 10% for waste.
- 3 When ordering casing for 6/8 doors: Jamb that are 80-5/8" BD use 7' casing on profiles 3" wide or smaller. Use 17' casing for profiles wider than 3" or for 8/0 doors. Jamb that are 81" BD use 7' casing on profiles 2-1/4" or smaller and 17' casing for profiles wider than 2-1/4" or for 8/0 doors.
- 4 Most door heads are cut from 7' legs (2- 3/0 heads or ONE door opening). Always cut the longest pieces first: door legs, window legs, long window heads and sills, and then door heads.
- 5 The most important tool when working with moulding is **patience**. Remember the old adage, measure twice and cut once. Never try to rush trim work.
- 6 Lengths ordered may not always be available. Always verify availability when ordering.

ALWAYS TEST TO MAKE SURE YOUR MEASURING TOOLS ARE ACCURATE. IF YOU ARE WORKING WITH A HELPER, TAKE A MEASUREMENT WITH ONE TOOL WHILE YOUR HELPER MEASURES WITH ANOTHER AND COMPARE YOUR RESULTS.

FINISHING

1 Fill nail holes with your choice of nail filler, patch or putty; experiment for best results.

2 Sand lightly and vacuum dusty film.

3 Caulk miters, door stops and all gaps even if the casing is tight to the jamb. NOTE: MDF will shrink as much as 1/4" if proper acclimation did not occur. You may experience shrinkage if the hole is not fully filled. Pushing the putty twice firmly in the hole with help prevent shrinkage as the putty dries out.

4 Factory primed mouldings permit the use of both water-based and solvent-based finish coat applications. Avoid using any catalyzed paints or varnishes. A second prime coat or scuff sanding is optional. Apply the finish coats with brush, roller or spray using flat, semi-gloss, enamel or lacquer; whatever suits your requirements.

HELPFUL HINTS

- ❖ **Miter all inside corners** for baseboard, chair rail, and crown molding.
- ❖ **Glue all miters and splices**—both sides/pieces of each joint, to control moisture content and to prevent stain from wicking into the endgrain and darkening the miters joints.
- ❖ **Pre-assemble wide casing using miter clamps.** Without clamping pressure, glue joints will not reach the full strength of the glue.
- ❖ **CHECK the moisture content of all wood moulding:** for interior trim, the MC should be 8-10%; for exterior trim the MC should be 12-14%. For every 4% change in MC, wood moves 1%.
- ❖ **For painted trim:** caulk over any nails that are overdriven—countersunk too deep.
- ❖ **Last mouldings to be installed:** base, shoe and quarter rounds.
- ❖ **Chair rails** can be installed 32" to 36" from the floor.
- ❖ Use Rosettes and Plinth blocks at the corners of windows and doors to **eliminate the mitering process.**
- ❖ **After installation is complete:** caulk and/or putty all gaps and nail holes.
- ❖ Use any brand of spray furniture polish on saw blade as a **lubricant for easier cutting.**



LIKE ALL WOOD PRODUCTS, MDF ABSORBS AND DESORBS MOISTURE WITH CHANGES IN RELATIVE HUMIDITY. THE NORMAL RANGE OF INTERIOR HUMIDITY IS 40 TO 80%. INDUSTRY STANDARD FOR MAXIMUM EXPANSION AND CONTRACTION OF MDF DUE TO CHANGES IN RELATIVE HUMIDITY FROM 40% TO 85% IS .3%. THUS, SOME EXPANSION AND CONTRACTION OF MDF MOULDINGS MAY OCCUR.

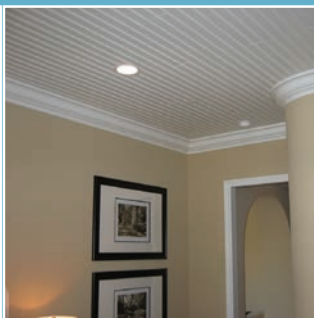

(items are approximate scale only)

1-1/4" to 2-1/4" Casing

lengths available: 7' & 17'



970LDF 11/16 x 1-1/4
LDF 2EE Door Header Fillet N/S



102MUL 9/16 x 1-9/16
Ultralight Beveled/Streamline Casing N/S



107MUL 9/16 x 1-5/8
Ultralight #711 Casing N/S



130MUL 5/8 x 1-5/8
Ultralight Moulded Casing N/S



121MUL 9/16 x 2
Ultralight Clamshell Casing S
(PRE-MITERED AVAILABLE) M



103MUL 9/16 x 2-1/4
Ultralight Beveled/Streamline Casing N/S



120MUL 5/8 x 2-1/4
Ultralight 2 Round Edge Casing N/S



146MUL-2 11/16 x 2-1/4
Ultralight Classic Beaded Casing N/S



2-1/4" Casing

(items are approximate scale only)

✂ lengths available: 7' & 17'



149MUL-2 11/16 x 2-1/4
Ultralight Meridian Casing N/S



152MUL 5/8 x 2-1/4 **Ultralight Colonial/#356 Casing** N/S
152BMUL 11/16 x 2-1/4 **Ultralight Colonial/#356 Casing** N/S
 (PRE-MITERED AVAILABLE) M



158MUL-2 9/16 x 2-1/4
Ultralight 4-Flute & Reed Casing N/S
 (Reversible)



162MUL-2 5/8 x 2-1/4
Ultralight #366 Casing S
 [FORMERLY 162MUL]



172MUL-2 11/16 x 2-1/4 **Ultralight Contemporary Casing** N/S



194MUL 11/16 x 2-1/4
Ultralight Tucson Casing S
 [FORMERLY 104MUL]



195MUL 9/16 x 2-1/4
Ultralight Clamshell Casing S
 [FORMERLY 105MUL]



196MUL 9/16 x 2-1/4
Ultralight Peoria Casing S
 [FORMERLY 106MUL]



(items are approximate scale only)

2-7/16" to 2-1/2" Casing

lengths available: 7' & 17'



132MUL 11/16 x 2-7/16
Ultralight Carolina/Palisade Casing N/S



167MUL 11/16 x 2-7/16
Ultralight Santa Fe/#275 Casing N/S



178MUL 11/16 x 2-7/16
Ultralight Howe Casing N/S



108MUL 5/8 x 2-1/2
Ultralight #711 Casing N/S
(PRE-MITERED AVAILABLE) 



110MUL 5/8 x 2-1/2
Ultralight 3-Step Casing N/S



128MUL 11/16 x 2-1/2
Ultralight Mission/Bel-Air Casing N/S



131MUL 5/8 x 2-1/2 **Ultralight Riviera Casing** N/S



134MUL 5/8 x 2-1/2
Ultralight Bay Shore/Bayport Casing N/S



135MUL-2 9/16 x 2-1/2
Ultralight Monterey/Colorado Casing N/S
[FORMERLY 123MUL]



137MUL 5/8 x 2-1/2
Ultralight Carmel Casing N/S



2-1/2" Casing

(items are approximate scale only)

✂ lengths available: 7' & 17'



138MUL 5/8 x 2-1/2
Ultralight Mackenzie Casing N/S



150MUL 5/8 x 2-1/2 **Ultralight Cape Cod Casing** N/S



157MUL 1-3/16 x 2-1/2 **Ultralight Bel-Air/Coronado Casing** N/S



159MUL 1 x 2-1/2 **Ultralight Lancaster/Hermosa Casing** N/S



164MUL 1-3/16 x 2-1/2 **Ultralight Bel Court Casing** S



169MUL 11/16 x 2-1/2 **Ultralight Victorian/Tudor Casing** N/S



197MUL 11/16 x 2-1/2 **Ultralight S4S Notched Modern Casing** N/S



198MUL 11/16 x 2-1/2 **Ultralight Ogee Casing** N/S

(items are approximate scale only)

2-9/16" to 3" Casing

lengths available: 7' & 17'



181MUL 1 x 2-9/16 **Ultralight Malibu Casing** S



168MUL 3/4 x 2-5/8 **Ultralight Santa Clara/Crescent Casing** N/S



119MUL 11/16 x 2-7/8 **Ultralight Solano/Colonial Casing** N/S



125MUL 11/16 x 2-7/8 **Ultralight Victorian/Newport Casing** N/S



122MUL 3/4 x 2-3/4 **Ultralight 2 Round Edge Casing** N/S
122MUL-SC 9/16 x 2-3/4 **Ultralight Scant 2 Round Edge Casing** N/S



127MUL 5/8 x 3 **Ultralight Del Mar/New Hampshire Casing** N/S



3" to 3-1/4" Casing

(items are approximate scale only)

✂ lengths available: 7' & 17'



165MUL 11/16 x 3 **Ultralight Santa Fe/#275 Casing** N/S



192MUL 11/16 x 3 **Ultralight Intrada Casing** N/S



129MUL 3/4 x 3-1/4 **Ultralight Mission/Bel-Air Casing** N/S



133MUL 11/16 x 3-1/4 **Ultralight Carolina/Palisade Casing** N/S



135MUL-3 11/16 x 3-1/4 **Ultralight Monterey/Colorado Casing** N/S

[FORMERLY 135MUL]

135MUL-3SC 11/16 x 3 **Ultralight Colorado Casing** S

[FORMERLY 124MUL]



(items are approximate scale only)

3-1/4" Casing

lengths available: 7' & 17'



139MUL 11/16 x 3-1/4 **Ultralight 2 Round Edge Casing** N/S
139MUL-SC 9/16 x 3-1/4 **Ultralight Scant 2 Round Edge Casing** N/S



154MUL 9/16 x 3-1/4 **Ultralight 4-Flute Casing** S
(NOT REVERSIBLE)
[FORMERLY 109MUL]



160MUL 1-3/16 x 3-1/4 **Ultralight Lancaster/Hermosa Casing** N/S



161MUL 11/16 x 3-1/4 **Ultralight Cambridge Casing** S

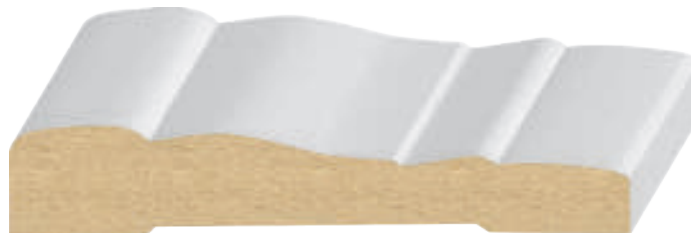

162MUL-3 5/8 x 3-1/4 **Ultralight #366 Casing** S **NEW**
[FORMERLY 163MUL]



3-1/4" Casing

(items are approximate scale only)

✂ lengths available: 7' & 17'



170MUL 1 x 3-1/4 **Ultralight Victorian/Tudor Casing** N/S



176MUL 11/16 x 3-1/4 **Ultralight Moulded Colonial/#356 Casing** N/S
176MUL-SC 9/16 x 3-1/4 **Ultralight Scant #356 Casing** S



184MUL 5/8 x 3-1/4 **Ultralight Carmel Casing** N/S



186MUL 1 x 3-1/4 **Ultralight 49er Casing** N/S

(items are approximate scale only)

3-1/4" to 3-7/16" Casing

lengths available: 7' & 17'



191MUL 15/16 x 3-1/4 **Ultralight Chandler Casing** S



158MUL-3 9/16 x 3-3/8 **Ultralight (Reversible) 5-Flute & Reed Casing** N/S



180MUL 1-3/16 x 3-3/8 **Ultralight Malibu Casing** N/S



146MUL-3 7/8 x 3-7/16 **Ultralight Classic Beaded Casing** N/S



149MUL-3 7/8 x 3-7/16 **Ultralight Meridian Casing** N/S



3-1/2" Casing

(items are approximate scale only)

✂ lengths available: 7' & 17'



118MUL-3 9/16 x 3-1/2 **Ultralight Colonial Base/Casing** s



126MUL 1 x 3-1/2 **Ultralight Belmont/Crescent Casing** N/S

126MUL-SC 11/16 x 3-1/2 **Ultralight Scant Crescent Casing** s



147MUL 1-3/16 x 3-1/2 **Ultralight Savannah Casing** s



155MUL 11/16 x 3-1/2 **Ultralight Cape Cod Casing** N/S



156MUL 7/8 x 3-1/2 **Ultralight Shasta Casing** N/S

(items are approximate scale only)

3-1/2" Casing

lengths available: 7' & 17'



166MUL 1 x 3-1/2 **Ultralight Santa Fe/#275 Casing** N/S



172MUL-3 11/16 x 3-1/2 **Ultralight Contemporary Casing** N/S



173MUL 1-3/16 x 3-1/2 **Ultralight Crescent Casing** S



177MUL 1 x 3-1/2 **Ultralight Howe Casing** N/S



179MUL 11/16 x 3-1/2 **Ultralight Shasta Casing** N/S



3-1/2" to 4-1/8" Casing

(items are approximate scale only)

✂ lengths available: 7' & 17'



189MUL 1-3/16 x 3-1/2 **Ultralight Bel-Air Casing** N/S



183MUL 11/16 x 3-9/16 **Ultralight Georgian Casing** N/S



175MUL 7/8 x 3-3/4 **Ultralight Sierra/Tuscany Casing** N/S



193MUL 11/16 x 4 **Ultralight Bullhead Casing** S



174MUL 1-1/8 x 4-1/8 **Ultralight Howe Casing** N/S

(items are approximate scale only)

4-1/4" Casing

lengths available: 7' & 17'



118MUL-4 9/16 x 4-1/4 **Ultralight Colonial Base/Casing** **S**



136MUL 13/16 x 4-1/4 **Ultralight Monterey/Colorado Casing** **N/S**



140MUL 7/8 x 4-1/4 **Ultralight Tuscany Casing** **N/S**



143MUL 1-3/16 x 4-1/4 **Ultralight Williamsburg Casing** **S**

4-1/4" Casing

(items are approximate scale only)

✂ lengths available: 7' & 17'



146MUL-4 7/8 x 4-1/4 **Ultralight Classic Beaded Casing** N/S



148MUL 1-3/16 x 4-1/4 **Ultralight Malibu Casing** S



149MUL-4 7/8 x 4-1/4 **Ultralight Meridian Casing** N/S



158MUL-4 11/16 x 4-1/4 **Ultralight (Reversible) 6-Flute & Reed Casing** N/S

(items are approximate scale only)

4-1/4" to 4-1/2" Casing

lengths available: 7' & 17'



185MUL 1-3/16 x 4-1/4 **UltraLight Carolina Casing** N/S



145MUL 3/4 x 4-1/2 **UltraLight 2 Round Edge Craftsman Casing** N/S



187MUL 11/16 x 4-1/2 **UltraLight Boulder Casing** N/S



190MUL 1-3/16 x 4-1/2 **UltraLight Belvedere/Sedona Casing** N/S

Header

(items are approximate scale only)

lengths available: 16'



998MUL 1 x 4-1/2 **Ultralight Lintel Mold** N/S
[Used for Door Headers]



158MUL-5 9/16 x 5-1/2 **Ultralight (Reversible) 8-Flute & Reed Casing** S
[FORMERLY 171MUL]



144MUL 1-1/16 x 5-1/2 **Ultralight 1 Round Edge Craftsman Header** N/S

Door Stop

lengths available: 7', 8' & 17'



201MUL 7/16 x 1-1/4
Ultralight 1 Round Edge Stop N/S



202MUL 3/8 x 1-1/4
Ultralight 2 Round Edge Stop N/S

201LDF 7/16 x 1-1/4
1 Round Edge Stop N



203MUL 1/2 x 1-3/8
Ultralight 2 Round Edge Stop N/S



204MUL 7/16 x 1-1/4
Ultralight 2 Round Edge Stop N/S



210MUL 1/2 x 1-3/4
Ultralight Colonial/Ogee Stop N/S

(items are approximate scale only)

2-1/4" to 3-1/4" Base

lengths available: 7' & 17'



304MUL 3/8 x 2-1/4
Ultralight Streamline Base N/S



R304MUL-2 3/8 x 2-1/4
Ultralight Reversible Base N/S



310MUL 3/8 x 2-1/2
Ultralight #711 Base N/S



319MUL 1/2 x 2-1/2
Ultralight #356 Base S

310BMUL 7/16 x 2-1/2
Ultralight #711 Base S



311LDF-3N 1/2 x 3
Ultralight #711 Base S
[FORMERLY 311LDF-3]



314MUL-3 9/16 x 3-1/4
Ultralight Coronado/#623 Base N/S

314MUL-3SC 1/2 x 3-1/4
Ultralight Coronado/#623 Base N/S



320MUL 1/2 x 3-1/4
Ultralight Colonial/#356 Base N/S



3-1/4" to 3-1/2" Base

lengths available: 7' & 17'

(items are approximate scale only)



351MUL 9/16 x 3-1/4
Ultralight Sierra Base N/S



361MUL-3 9/16 x 3-1/4
Ultralight Monterey/Sonoma Base N/S



366MUL 9/16 x 3-1/4
Ultralight #366 Base S



735MUL 1/2 x 3-1/4 (w/ 3/8" Rab't)
Ultralight Wainscot Base N/S

736MUL 1/2 x 5 (w/ 3/8" Rab't)
Ultralight Wainscot Base N/S



118MUL-3 9/16 x 3-1/2
Ultralight Colonial Base/Casing S



307MUL 9/16 x 3-1/2
Ultralight Bullnose Base N/S



3-1/2" to 3-3/4" Base

lengths available: 16'

(items are approximate scale only)



311MUL 3/8 x 3-1/2 **Ultralight #711 Base** N/S
311BMUL 7/16 x 3-1/2 **Ultralight #711 Base** S



321MUL-3 1/2 x 3-1/2
Ultralight 3-Step Base N/S
 [FORMERLY 322MUL]



335MUL 7/16 x 3-1/2
Ultralight Monterey Base S



338MUL-3 9/16 x 3-7/16
Ultralight Santa Fe/ #175 Base N/S
 [FORMERLY 325MUL-3]



339MUL 9/16 x 3-1/2
Ultralight Santa Clara/ Crescent Base N/S



387MUL-3 7/16 x 3-1/2
Ultralight 1EE Craftsman Base N/S
 [FORMERLY 388MUL-3]



324MUL 9/16 x 3-3/4
Ultralight Mission/ Hermosa Base N/S



3-7/8" to 4-1/8" Base

lengths available: 16'

(items are approximate scale only)



313MUL 7/16 x 3-7/8
Ultralight Cape Cod Base S



329MUL 9/16 x 3-7/8
Ultralight Victorian/ Newport Base N/S



318MUL-4 9/16 x 4
Ultralight Cape Cod Base N/S
 [FORMERLY 318MUL]



321MUL-4 1/2 x 4-1/8
Ultralight 3-Step Base N/S
 [FORMERLY 321MUL]



(items are approximate scale only)

4-3/16" to 4-1/4" Base

lengths available: 16'



311MUL-4 7/16 x 4-3/16
#711 Base S
311LDF-4 7/16 x 4-3/16
#711 Base S



118MUL-4 9/16 x 4-1/4
**Ultralight
Colonial Base** S
362MUL-4 9/16 x 4-1/4
**Ultralight
Solano Base** N



314MUL-4 9/16 x 4-1/4
**Ultralight Coronado/
#620 Base** N/S



326MUL 9/16 x 4-1/4
**Ultralight Santa Clara/
Crescent Base** N/S



4-1/2" Base

lengths available: 16'

(items are approximate scale only)



325MUL 9/16 x 4-1/2
Ultralight Imperial/#175 Base N/S



327MUL-4 9/16 x 4-1/2
**Ultralight Del Mar/
New Hampshire Base** N/S
[FORMERLY 327MUL]



338MUL-4 9/16 x 4-1/2
Ultralight Santa Fe/#175 Base N/S



(items are approximate scale only)

4-1/2" Base

lengths available: 16'

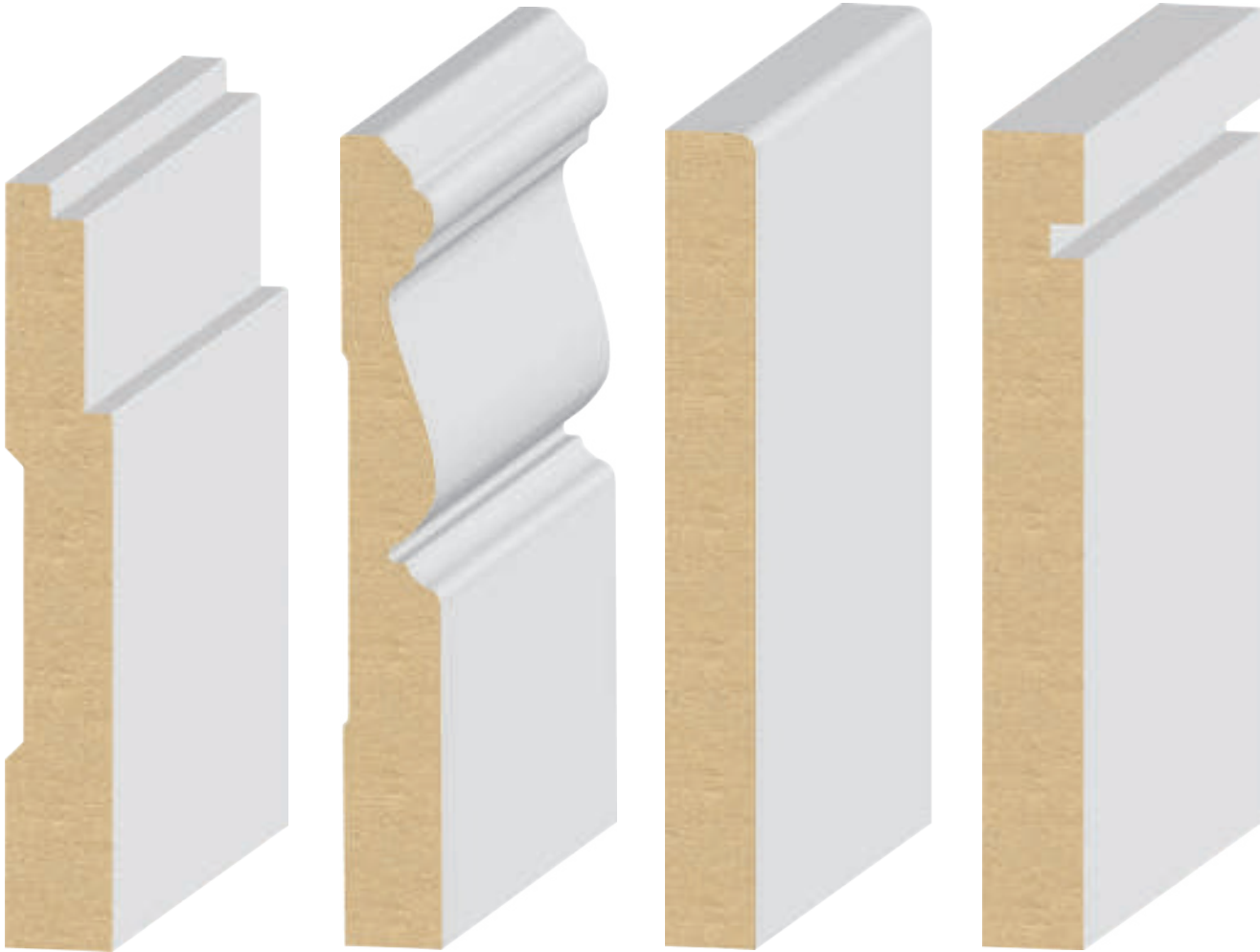

349MUL-4 9/16 x 4-1/2
Ultralight Meridian Base N/S

361MUL-4 9/16 x 4-1/2
Ultralight Monterey/Sonoma Base N/S

387MUL-4 1/2 x 4-1/2
Ultralight 1 Eased Edge Craftsman Base N/S
[FORMERLY 388MUL-4]

392MUL-4 9/16 x 4-1/2
Ultralight S4S Notched Modern Base N/S



5" Base

✂ lengths available: 16'

(items are approximate scale only)



323MUL 9/16 x 5
**Ultralight Mission/
Hermosa Base** N/S



330MUL 9/16 x 5
Ultralight Newport Base S

330BMUL 9/16 x 5-1/4
Ultralight Victorian/Newport Base N/S



390MUL 9/16 x 5
**Ultralight
Intrada Base** N/S



(items are approximate scale only)

5-1/4" Base

lengths available: 16'



314MUL-5 9/16 x 5-1/4
Ultralight Coronado/#618 Base N/S
[FORMERLY 315MUL]

314MUL-5SC 1/2 x 5-1/4
Ultralight Scant Coronado Base N



317MUL 9/16 x 5-1/4
**Ultralight
Crescent Base** S



318BMUL 9/16 x 5-1/4
**Ultralight
"B" Cape Cod Base** S



5-1/4" Base

lengths available: 16'

(items are approximate scale only)



318MUL-5 9/16 x 5-1/4
Ultralight Cape Cod Base N/S



327MUL-5 9/16 x 5-1/4
**Ultralight Del Mar/
New Hampshire Base** N/S



328MUL-5 9/16 x 5-1/4
**Ultralight Vintage/
Colonial Base** N/S
[FORMERLY 328MUL]



(items are approximate scale only)

5-1/4" Base

lengths available: 16'



338MUL-5 9/16 x 5-1/4
Ultralight
Santa Fe/#175 Base N/S
[FORMERLY 338MUL]



341MUL 9/16 x 5-1/4
Ultralight
Monterey Base S



349MUL-5 9/16 x 5-1/4
Ultralight
Meridian Base N/S



350MUL 9/16 x 5-1/4
Ultralight
Georgian Base N/S

5-1/4" Base

✦ lengths available: 16'

(items are approximate scale only)



352MUL 9/16 x 5-1/4
UltraLight Sierra Base N/S
352MUL-SC 1/2 x 5-1/4
UltraLight Scant Sierra Base N



355MUL 9/16 x 5-1/4
UltraLight Harris Base N/S



361MUL-5 9/16 x 5-1/4
**UltraLight Monterey/
Sonoma Base** N/S
[FORMERLY 361MUL]



(items are approximate scale only)

5-1/4" Base

lengths available: 16'



118MUL-5 9/16 x 5-1/4
Ultralight Colonial Base S

362MUL-5 9/16 x 5-1/4
Ultralight Solano Base N



365MUL 5/8 x 5-1/4
Ultralight Lancaster Base S



368MUL 9/16 x 5-1/4
Ultralight #566 Base S

5-1/4" to 5-1/2" Base

lengths available: 16'

(items are approximate scale only)



372MUL-5 1/2 x 5-1/4
Ultralight Contemporary Base N/S



359MUL 9/16 x 5-7/16
Ultralight Classic Beaded Base N/S
[FORMERLY 377MUL]



354MUL 9/16 x 5-1/2
Ultralight Bullnose Base N/S



(items are approximate scale only)

5-1/2 to 6" Base

lengths available: 16'

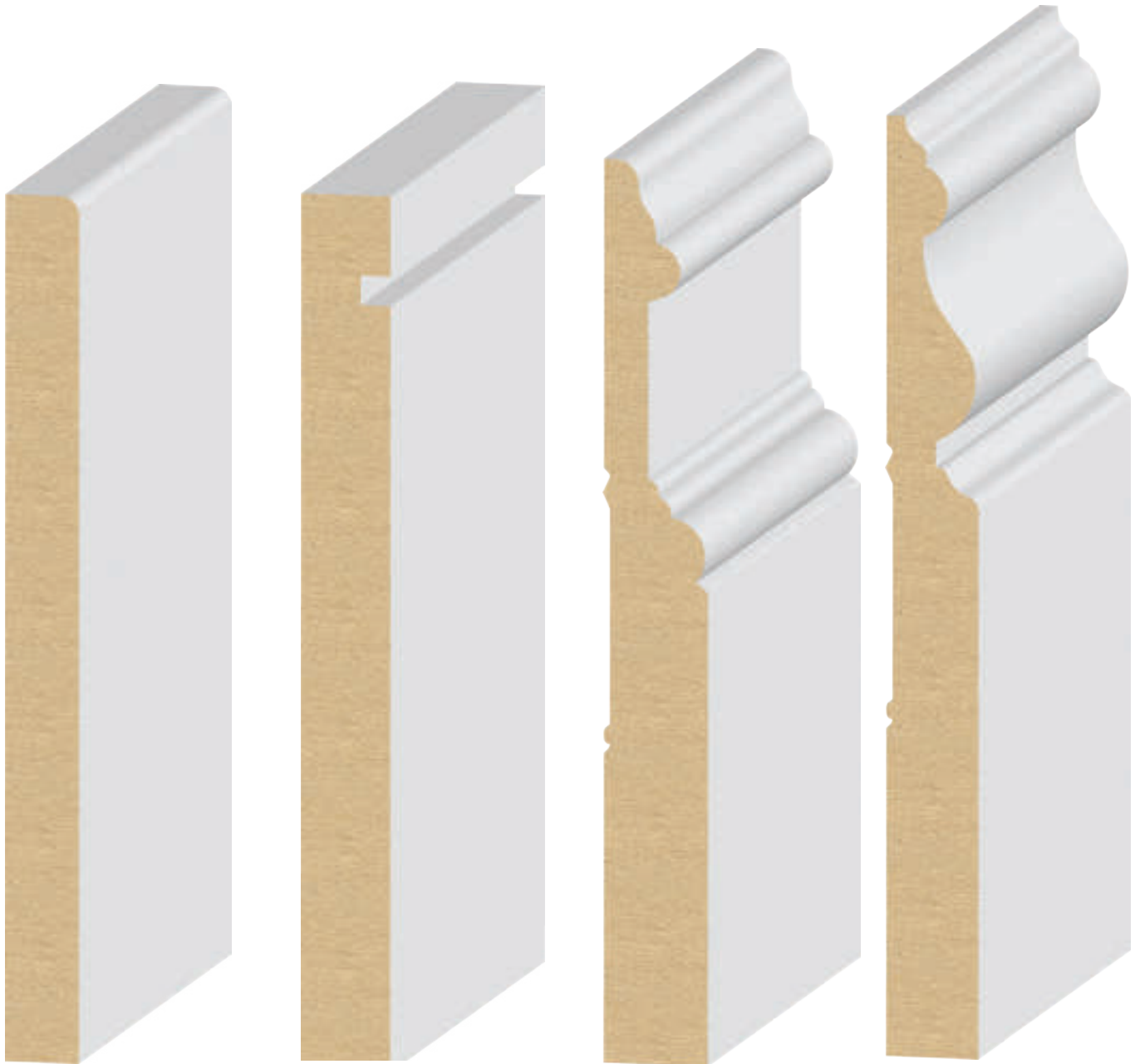

387MUL-5 1/2 x 5-1/2
Ultralight
1 Eased Edge Base N/S
[FORMERLY 388MUL-5]

392MUL-5 9/16 x 5-1/2
Ultralight S4S Notched
Modern Base N/S

332MUL 11/16 x 5-3/4
**Ultralight Santa Clara/
Crescent Base** N/S

342MUL-6 9/16 x 6
**Ultralight Imperial/
#175 Base** N/S
[FORMERLY 342MUL]



6" to 6-1/8" Base

lengths available: 16'

(items are approximate scale only)



375MUL 1 1/16 x 6
Ultralight Tuscany Base N/S



385MUL 5/8 x 6
**Ultralight Carolina/
Palisade Base** N/S



328MUL-6 9/16 x 6-1/8
**Ultralight Vintage/
Colonial Base** N/S



(items are approximate scale only)

6-1/2" to 7-1/4" Base

lengths available: 16'



334MUL 3/4 x 6-1/2
Ultralight Vermont Base S

334BMUL 9/16 x 6-1/2
**Ultralight Savannah/
Vermont Base** N/S
(THIN VERSION)



389MUL 11/16 x 6-1/2
Ultralight Plinth Base N/S



118MUL-7 9/16 x 7-1/4
Ultralight Colonial Base S

7-1/4" Base

lengths available: 16'

(items are approximate scale only)



314MUL-7 9/16 x 7-1/4
**Ultralight Coronado/
#613 Base** N/S



333MUL 9/16 x 7-1/4
**Ultralight Mission
Bay Base** N/S



340MUL 9/16 x 7-1/4
**Ultralight Malibu/
Hermosa Base** N/S



342MUL-7 9/16 x 7-1/4
**Ultralight Imperial/
#175 Base** N/S



(items are approximate scale only)

7-1/4" Base

✂ lengths available: 16'



343MUL 9/16 x 7-1/4
Ultralight Laguna Base S



345MUL 5/8 x 7-1/4
**Ultralight Santa Clara/
Crescent Base** N/S



349MUL-7 5/8 x 7-1/4
**Ultralight
Meridian Base** N/S



7-1/4" Base

lengths available: 16'

(items are approximate scale only)



353MUL 9/16 x 7-1/4
UltraLight Sierra Base N/S



358MUL 9/16 x 7-1/4
UltraLight Bullnose Base N/S



360MUL 9/16 x 7-1/4
UltraLight Classic Beaded Base N/S
[FORMERLY 376MUL]



(items are approximate scale only)

7-1/4" to 7-3/8" Base

✂ lengths available: 16'



361MUL-7 9/16 x 7-1/4
**Ultralight Monterey/
Sonoma Base** N/S
[FORMERLY 386MUL]



372MUL-7 1/2 x 7-1/4
**Ultralight
Contemporary
Base** N/S



387MUL 1/2 x 7-1/4
**Ultralight
1 Eased Edge
Craftsman Base** N/S



379MUL 1 x 7-3/8
**Ultralight
Savannah Base** S



8" to 8-1/2" Base

lengths available: 16'

(items are approximate scale only)



331MUL 9/16 x 8
**Ultralight Victorian/
Newport Base** N/S



342MUL-8 5/8 x 8-1/4
**Ultralight Imperial/
#175 Base** N/S
[FORMERLY 357MUL]



380MUL 1 x 8-1/2
Ultralight Savannah Base S



(items are approximate scale only)

8-1/2" Base

lengths available: 16'



381MUL 1 x 8-1/2 Ultralight Camden Base **S**

382MUL 1 x 8-1/2 Ultralight Williamsburg Base **S**



9-1/4" Base

lengths available: 16'

(items are approximate scale only)



338MUL-9

9/16 x 9-1/4

Ultralight Santa Fe/#175 Base N/S

[FORMERLY 384MUL]

361MUL-9

9/16 x 9-1/4

Ultralight Monterey/Sonoma Base N/S

[FORMERLY 383MUL]



(items are approximate scale only)

Pediment Crown

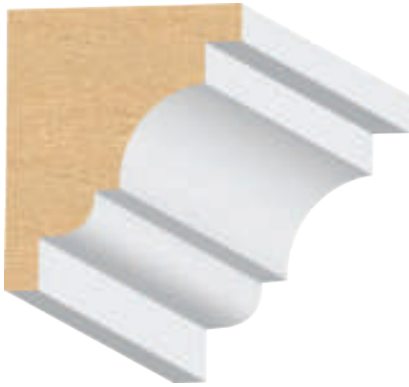

438MUL 1-3/16 x 1-1/2
Ultralight Pediment Crown N/S



419MUL 1 x 1-7/8
Ultralight Corner Crown/Mold N/S



440MUL 1-3/8 x 2-3/4
Ultralight Classic Pediment Crown N/S



439MUL 1-3/16 x 3
Ultralight Pediment Crown N/S

1-7/8" to 3-1/4" Crown Mold

(items are approximate scale only)

✂ lengths available: 16'



420MUL 9/16 x 1-7/8
Ultralight Bed Mold **S**

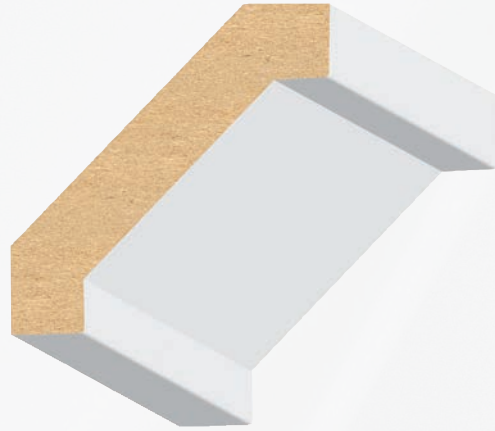

460MUL-2 9/16 x 2-3/8
Ultralight Craftsman Crown **N/S**



462MUL-2 9/16 x 2-7/16
Ultralight Ogee Crown **N**



402MUL 9/16 x 2-1/2
Ultralight Bed Mold/Crown **S**



404MUL 9/16 x 2-5/8
Ultralight Colonial Crown **S**
[FORMERLY 401MUL]



405MUL 9/16 x 3-1/4
Ultralight Colonial Crown **S**

436MUL 9/16 x 2-3/4
Ultralight Colonial Crown **N/S**

(items are approximate scale only)

3-1/4" to 3-7/16" Crown Mold

✂ lengths available: 16'

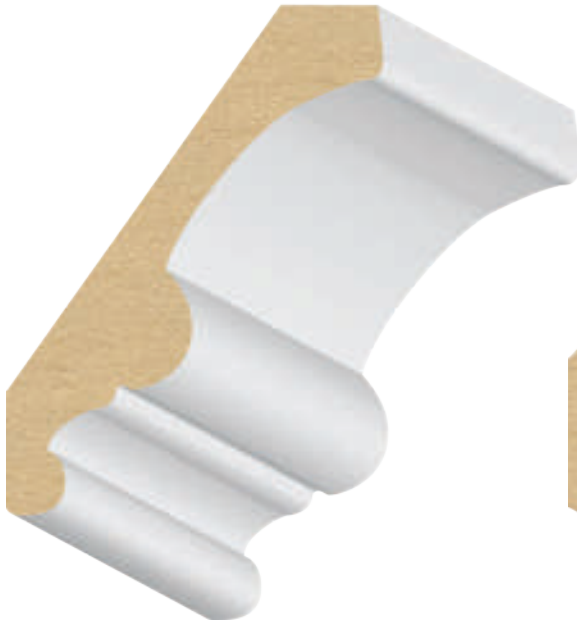

441MUL 11/16 x 3-1/4
Ultralight Single Beaded Crown N/S



421MUL 3/4 x 3-3/8
**Ultralight Double Bead
Carolina Crown** N/S



444MUL-3 9/16 x 3-3/8
Ultralight Contemporary Crown N/S

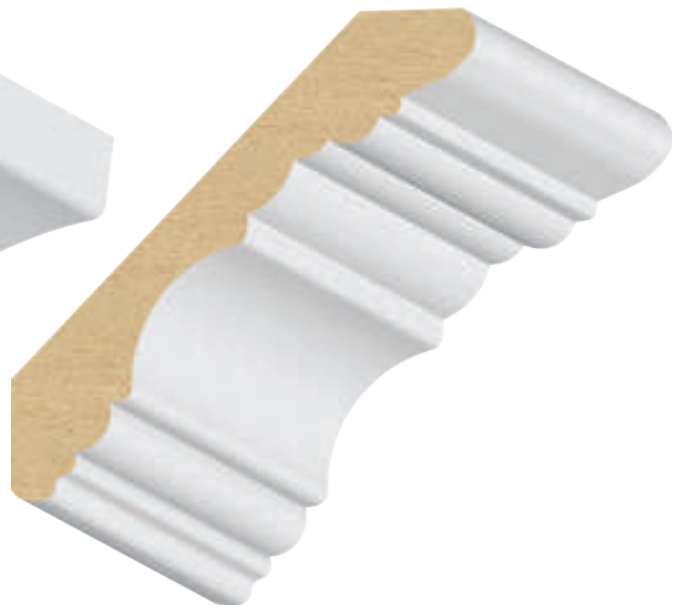

426MUL 9/16 x 3-7/16
**Ultralight Coronado/
Georgian Crown** N/S

3-5/8" to 4-1/4" Crown Mold

(items are approximate scale only)

✂ lengths available: 16'

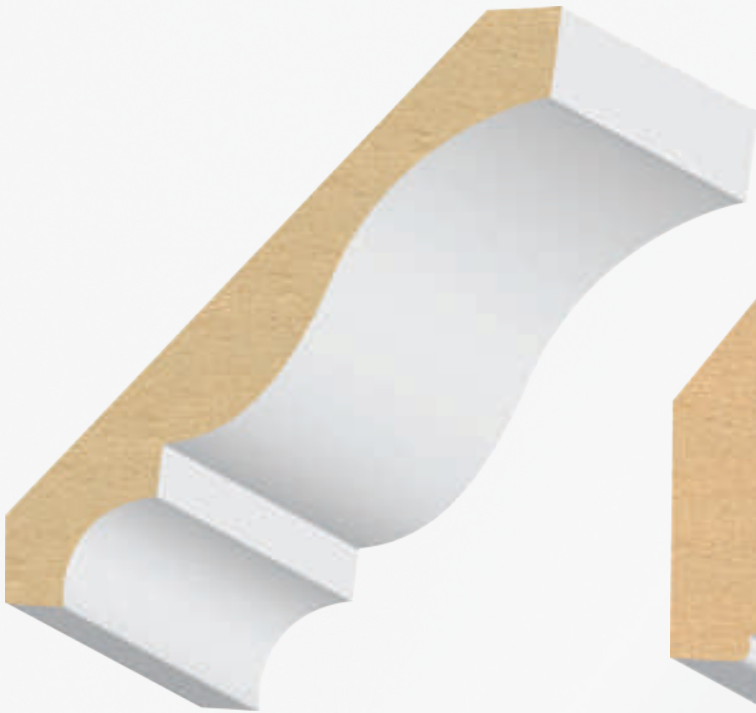

446MUL 5/8 x 3-5/8
Ultralight Colonial Crown N/S



451MUL 1-3/16 x 3-3/4
Ultralight Cornice Crown S
[FORMERLY 411MUL]



425MUL-3 3/4 x 3-3/4
Ultralight Dentil Ready Crown N/S

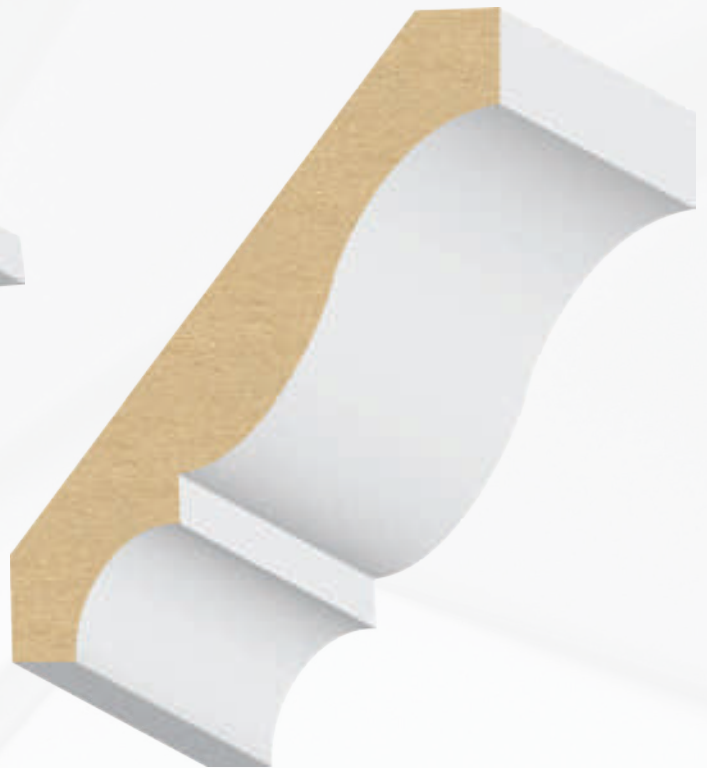

406MUL 9/16 x 4-1/4
Ultralight Colonial Crown N/S



(items are approximate scale only)

4-1/4" Crown Mold

lengths available: 16'



407MUL 1-3/16 x 4-1/4
Ultralight Cornice Crown S

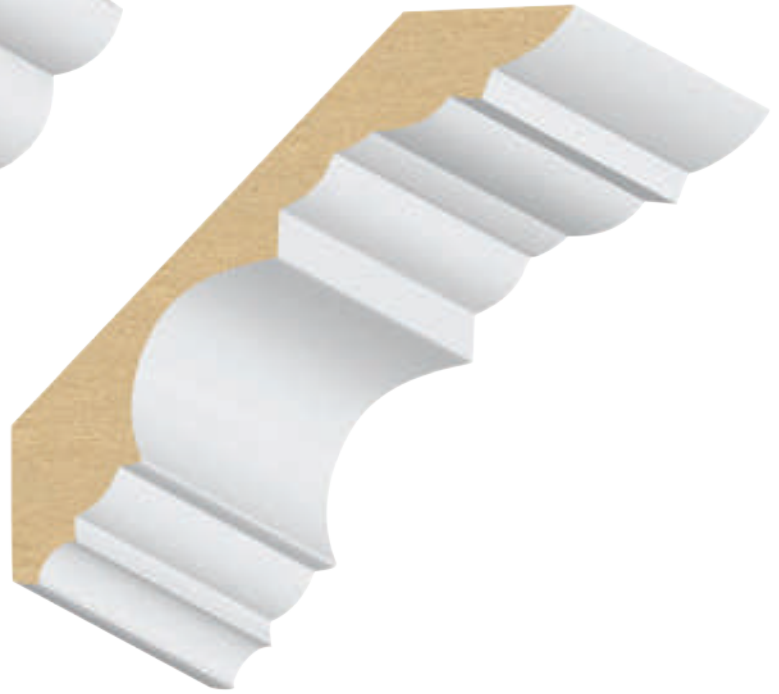

467MUL 3/4 x 4-1/4
Ultralight Tempe Crown S

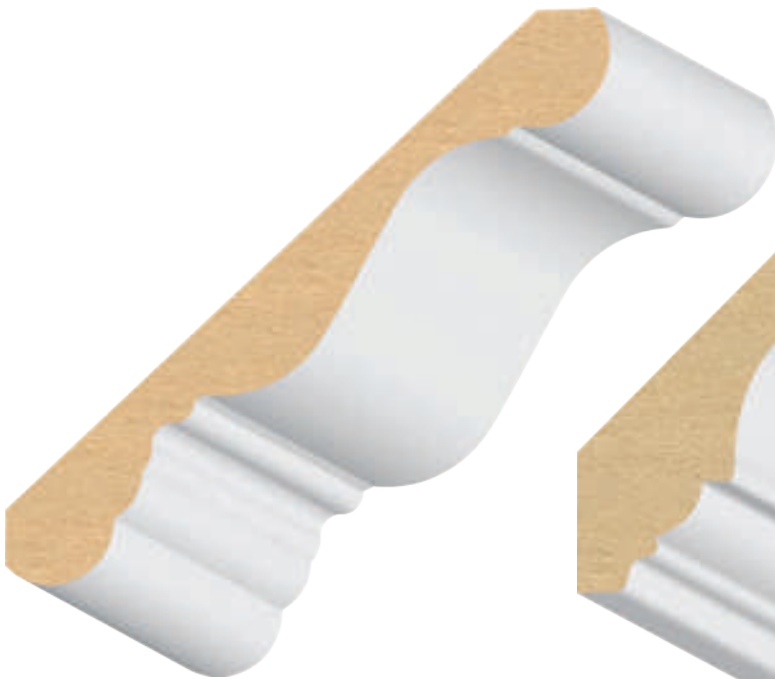

410MUL-4 9/16 x 4-1/4
Ultralight Small Charleston Crown N/S
[FORMERLY 413MUL]



434MUL 7/8 x 4-1/4
Ultralight Coronado Crown N

4-1/4" to 4-1/2" Crown Mold

(items are approximate scale only)

lengths available: 16'

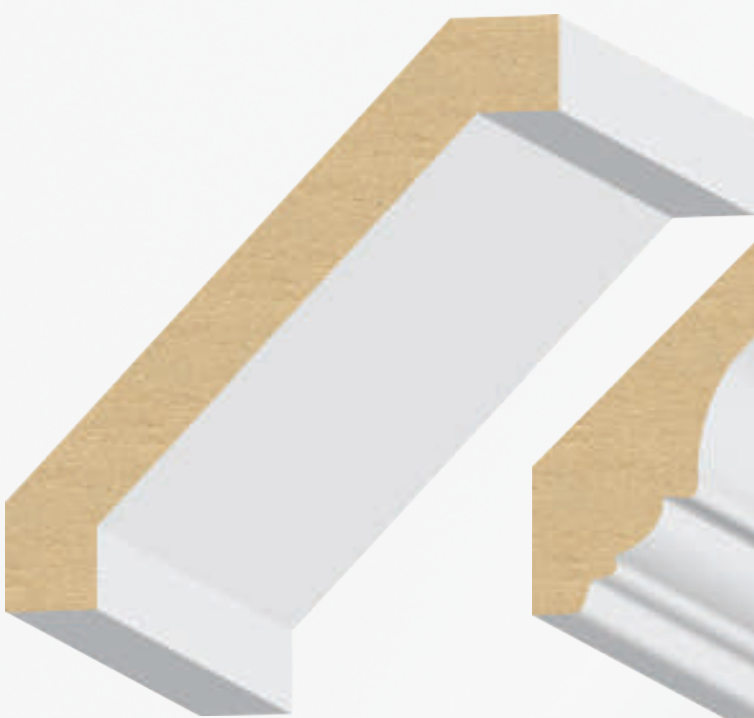

460MUL-4 11/16 x 4-1/4
Ultralight Craftsman Crown N/S



412MUL 9/16 x 4-1/2
Ultralight Coronado/Georgian Crown N/S



422MUL 9/16 x 4-1/2
Ultralight Savannah Crown S



409MUL 3/4 x 4-1/2
Ultralight Rancho Crown N/S



(items are approximate scale only)

4-1/2" to 4-5/8" Crown Mold

lengths available: 16'

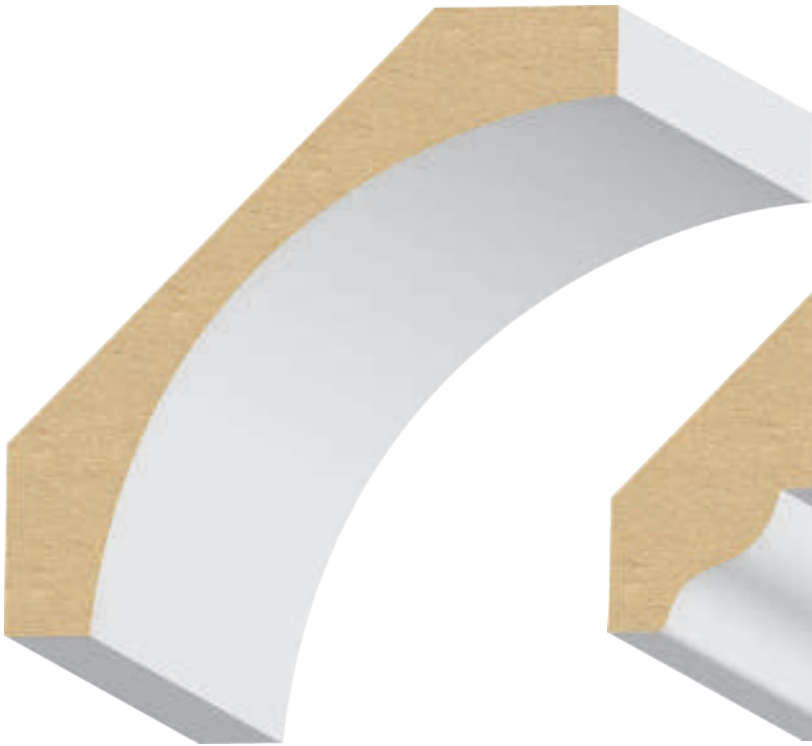

444MUL-4 1 x 4-1/2
Ultralight Contemporary Crown N/S



462MUL-4 3/4 x 4-9/16
Ultralight Ogee Crown N



408MUL-4 3/4 x 4-5/8
Ultralight Cornice N/S

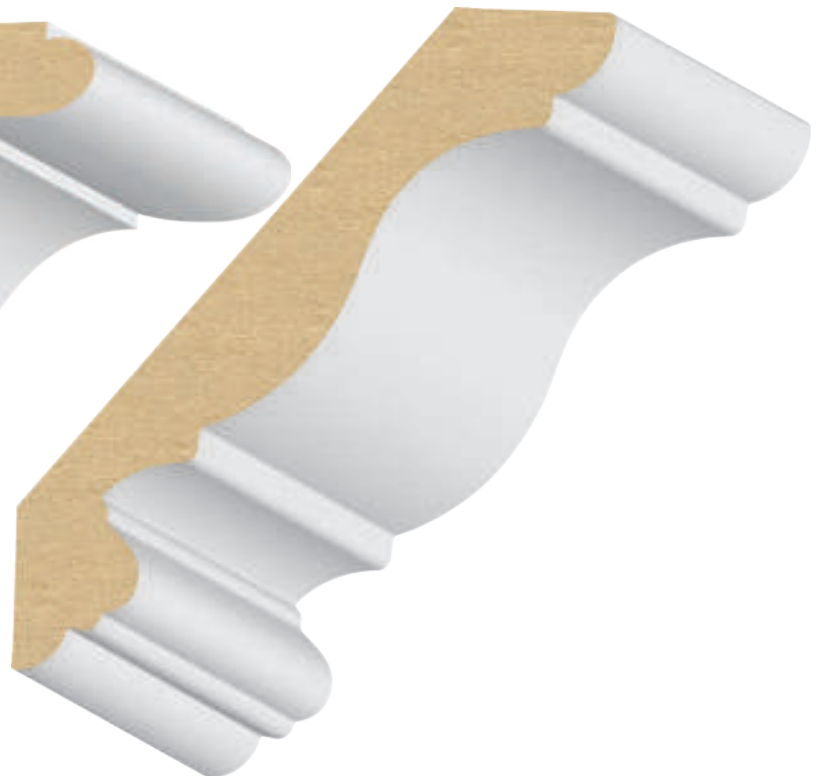

411MUL-4 3/4 x 4-5/8
Ultralight Rafael Crown N/S



4-5/8" to 5" Crown Mold

(items are approximate scale only)

lengths available: 16'



423MUL 7/8 x 4-5/8
Ultralight Double Bead Carolina Crown N/S
423BMUL 11/16 x 4-5/8
Ultralight Double Bead Carolina Crown N/S

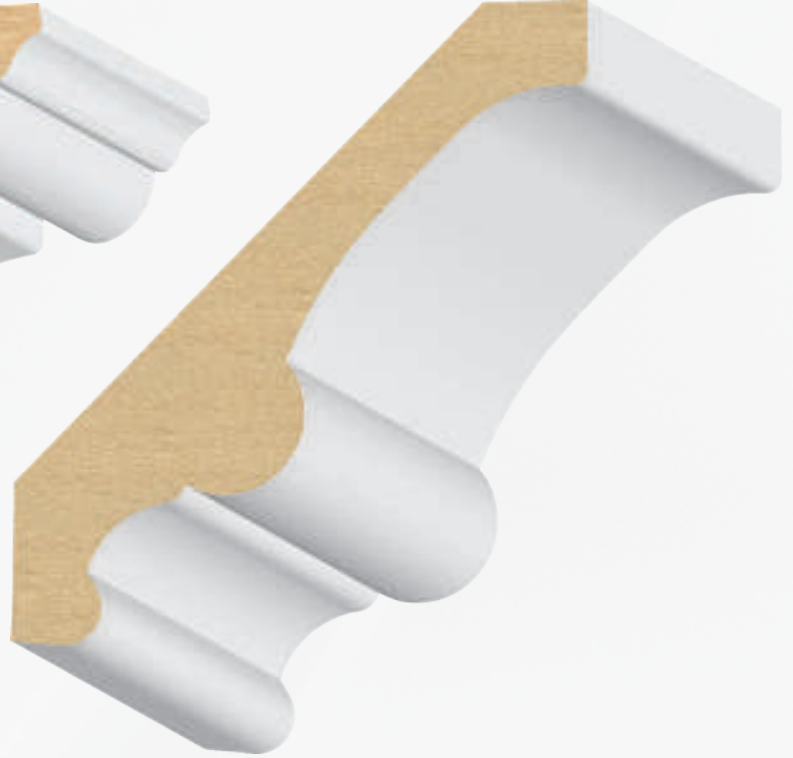

442MUL 11/16 x 4-5/8
Ultralight Single Beaded Crown N/S
[FORMERLY 430MUL]



469MUL 3/4 x 4-11/16
Ultralight Scottsdale Crown S



410MUL-5 11/16 x 5
Ultralight Charleston Crown N/S



(items are approximate scale only)

5" to 5-1/4" Crown Mold

lengths available: 7' & 17'



465LDF-5 1-1/4 x 5
LDF King George Crown **NEW** s



455LDF 11/16 x 5-1/16
Ultralight Dentil Crown **N/S**



460MUL-5 3/4 x 5-1/4
Ultralight Craftsman Crown **N/S**

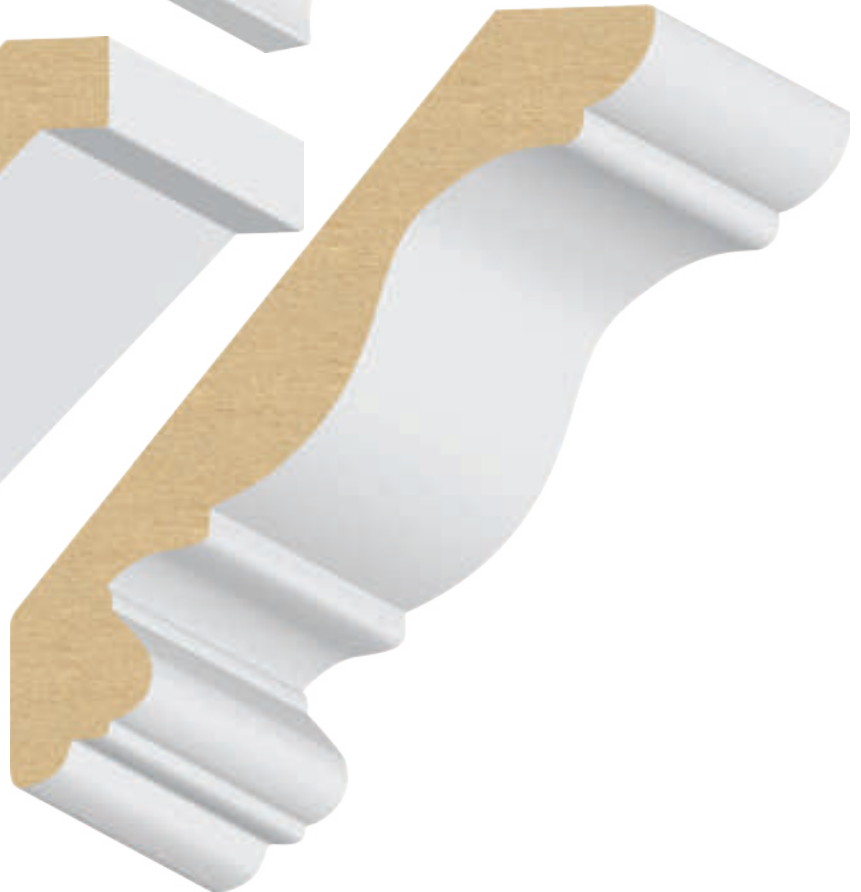

411MUL-5 3/4 x 5-1/4
Ultralight Rafael Crown **N/S**



5-1/4" Crown Mold

lengths available: 16'

(items are approximate scale only)

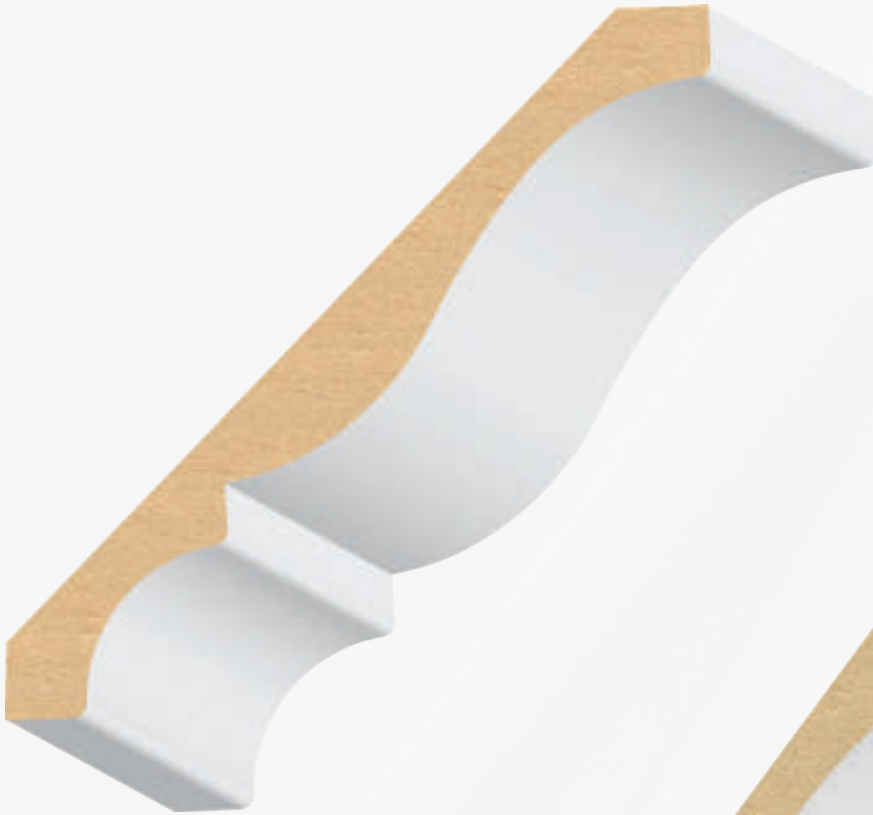

414MUL 9/16 x 5-1/4 **Ultralight Colonial Crown** N/S
(larger cove at bottom; for smaller cove see 414LDF)



414LDF 9/16 x 5-1/4 **Colonial Crown** N
(smaller cove at bottom; for larger cove see 414MUL)



(items are approximate scale only)

5-1/2" to 5-5/8" Crown Mold

lengths available: 16'

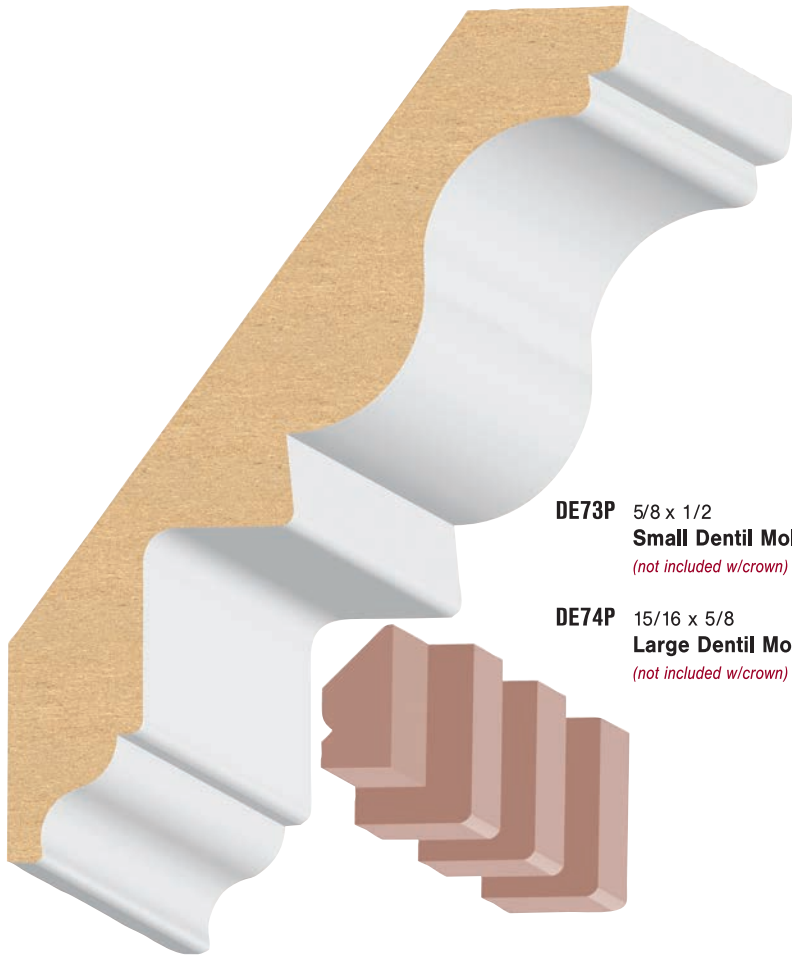

DE73P 5/8 x 1/2
Small Dentil Mold N/S
(not included w/crown)

DE74P 15/16 x 5/8
Large Dentil Mold N/S
(not included w/crown)

425MUL-5 13/16 x 5-1/2 **Ultralight Dentil Ready Crown** N/S



444MUL-5 1-1/16 x 5-5/8 **Ultralight Contemporary Crown** N/S
[FORMERLY 444MUL]

6" Crown Mold

lengths available: 16'

(items are approximate scale only)



408MUL-6 1 x 6 **Ultralight Cornice** N/S
[FORMERLY 408MUL]

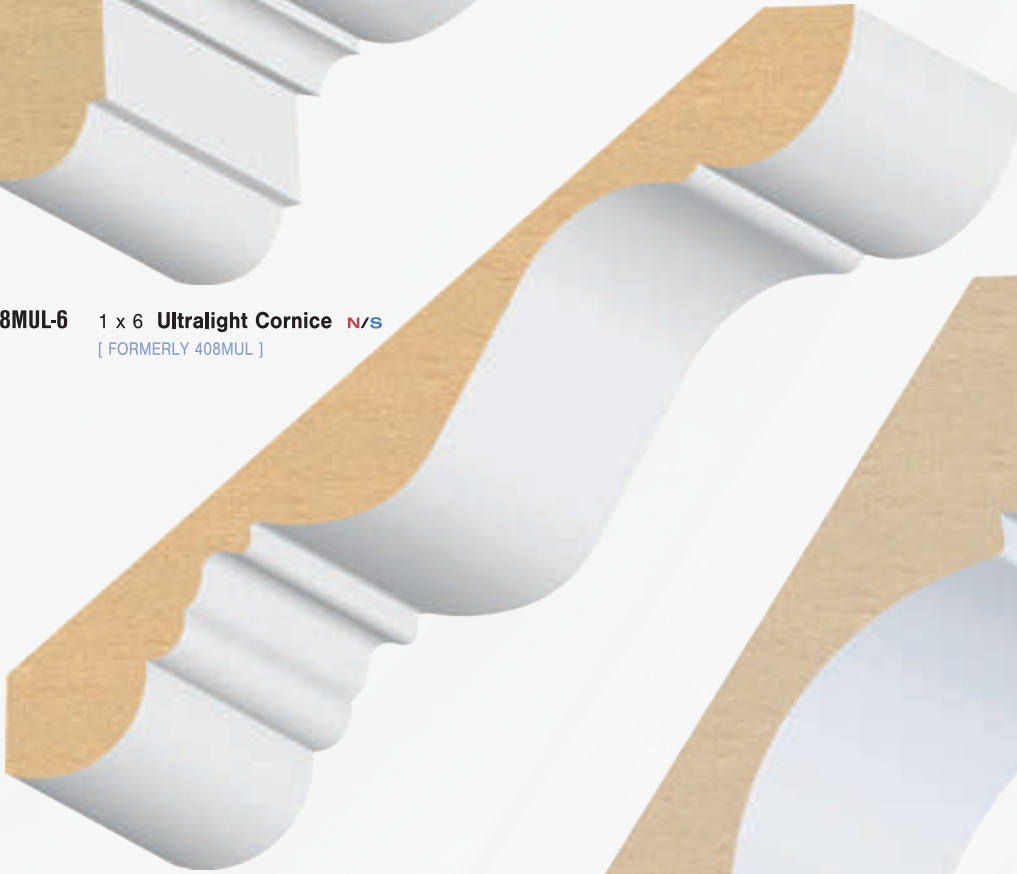

410MUL-6 1 1/16 x 6 **Ultralight Charleston Crown** N/S
[FORMERLY 410MUL]



453MUL 1-3/16 x 6
**Ultralight Nantucket/
La Costa Crown** N/S



(items are approximate scale only)

6" to 6-1/4" Crown Mold

✦ lengths available: 16'



462MUL-6 7/8 x 6 **Ultralight Ogee Crown** N



435MUL 1 x 6-1/4 **Ultralight Regal Crown** N/S



6-1/4" to 6-7/16" Crown Mold

(items are approximate scale only)

✂ lengths available: 16'



411MUL-6 3/4 x 6-1/4 **Ultralight Rafael Crown** N/S

448MUL 3/4 x 6-7/16 **Ultralight Cape Cod Crown** N/S



(items are approximate scale only)

6-1/2" Crown Mold

lengths available: 16

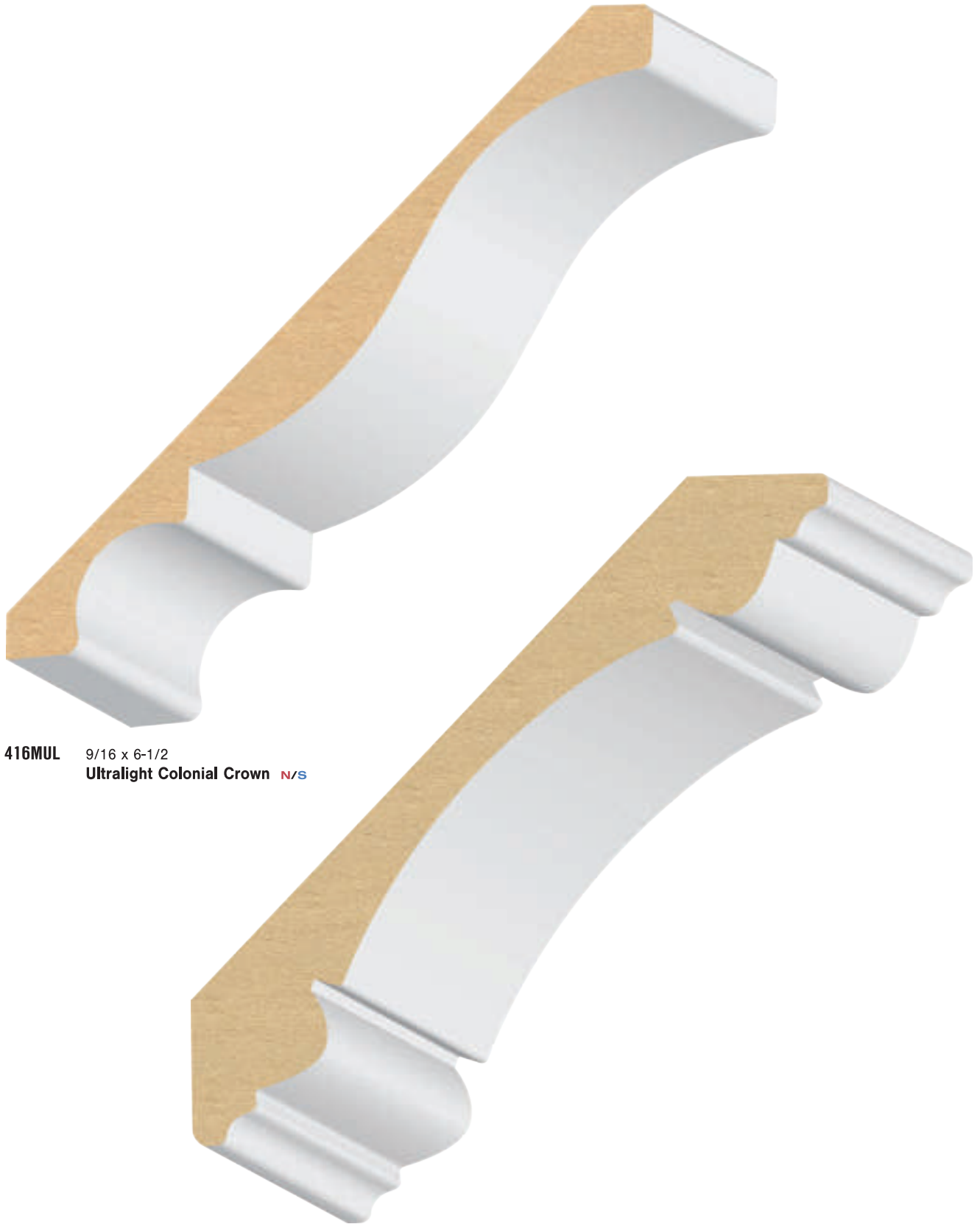

416MUL 9/16 x 6-1/2
Ultralight Colonial Crown N/S

424MUL-6 1 x 6-1/2
Ultralight Double Bead Carolina Crown N/S
[FORMERLY 424MUL]



6-9/16" Crown Mold

(items are approximate scale only)

✂ lengths available: 16'



443MUL 7/8 x 6-9/16
UltraLight Single Beaded Crown N/S
 [FORMERLY 431MUL]

447MUL 7/8 x 6-9/16 **UltraLight Coronado Crown** N
427MUL 3/4 x 6-1/2 **UltraLight Georgian Crown** S



(items are approximate scale only)

6-3/4" to 6-7/8" Crown Mold

lengths available: 16'

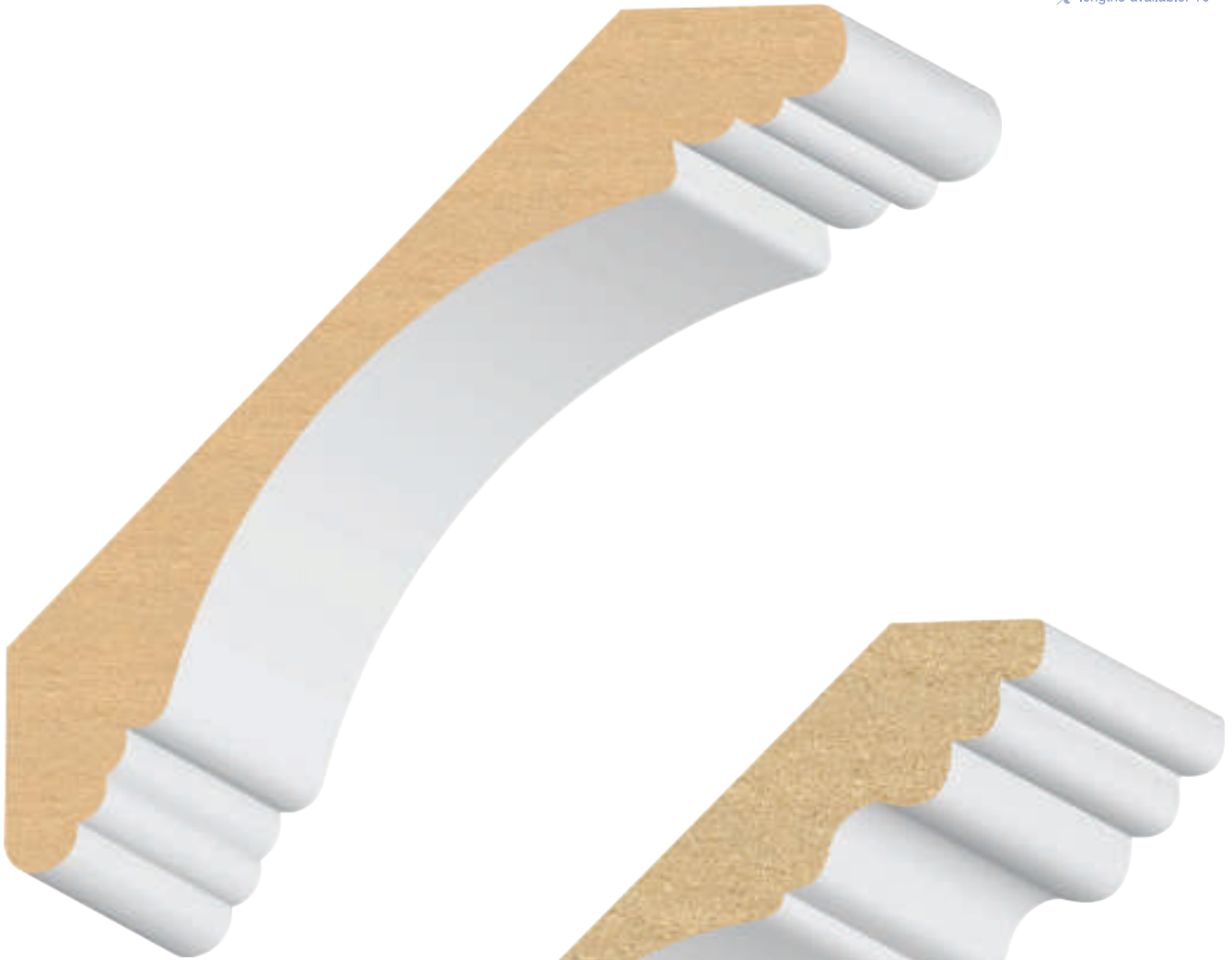

433MUL 1-3/16 x 6-3/4
Ultralight Del Mar Crown s



437MUL 13/16 x 6-7/8
Ultralight Santa Clara Crown N/S



7" to 7-3/16" Crown Mold

(items are approximate scale only)

✂ lengths available: 16'

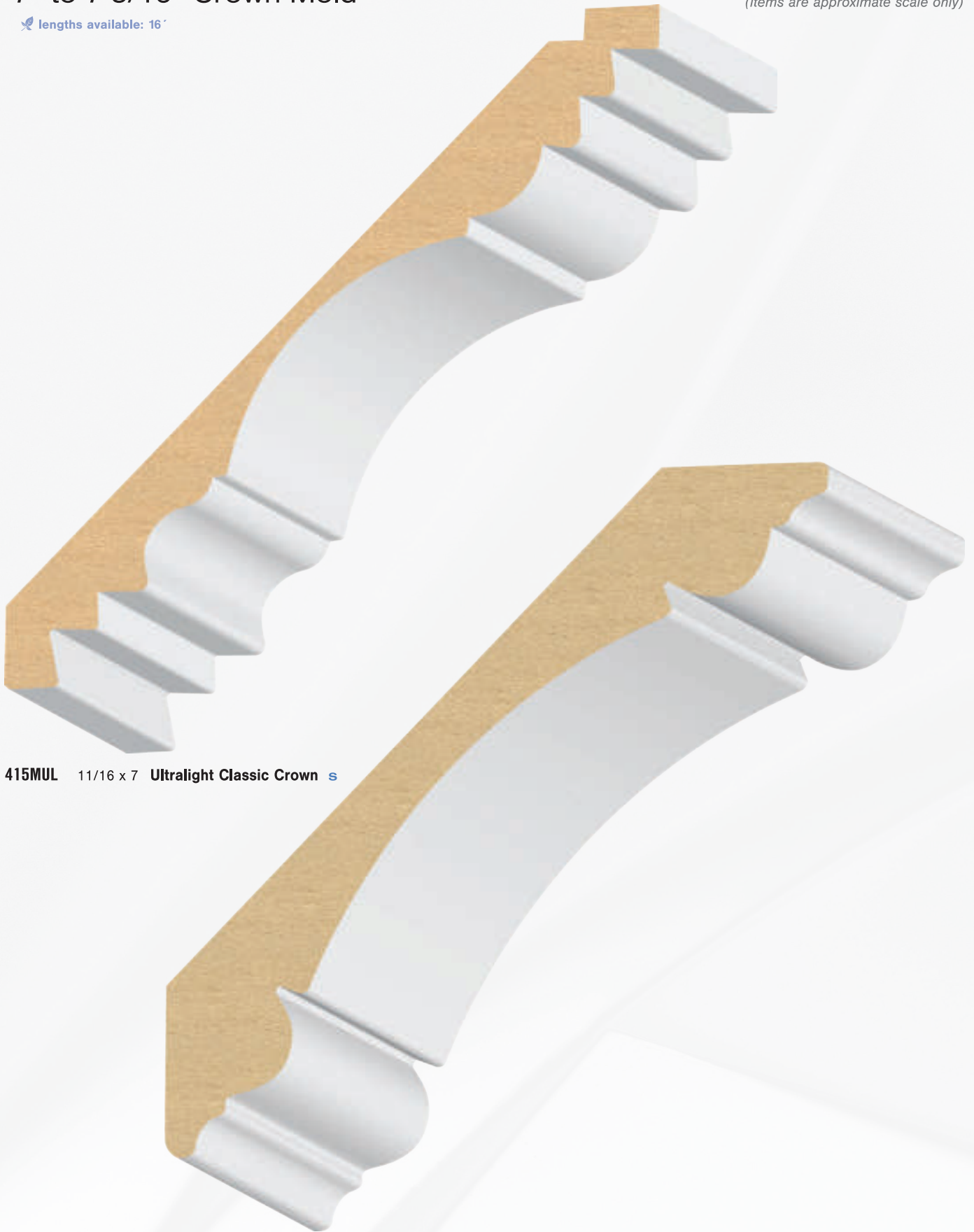

415MUL 1 1/16 x 7 **Ultralight Classic Crown** **S**

424MUL-7 1-1/8 x 7-3/16 **Ultralight Double Bead Carolina Crown** **N/S**
424LDF-7 1 x 7-3/16 **LDF Double Bead Carolina Crown** **N**

7-1/4" Crown Mold

lengths available: 16'

(items are approximate scale only)

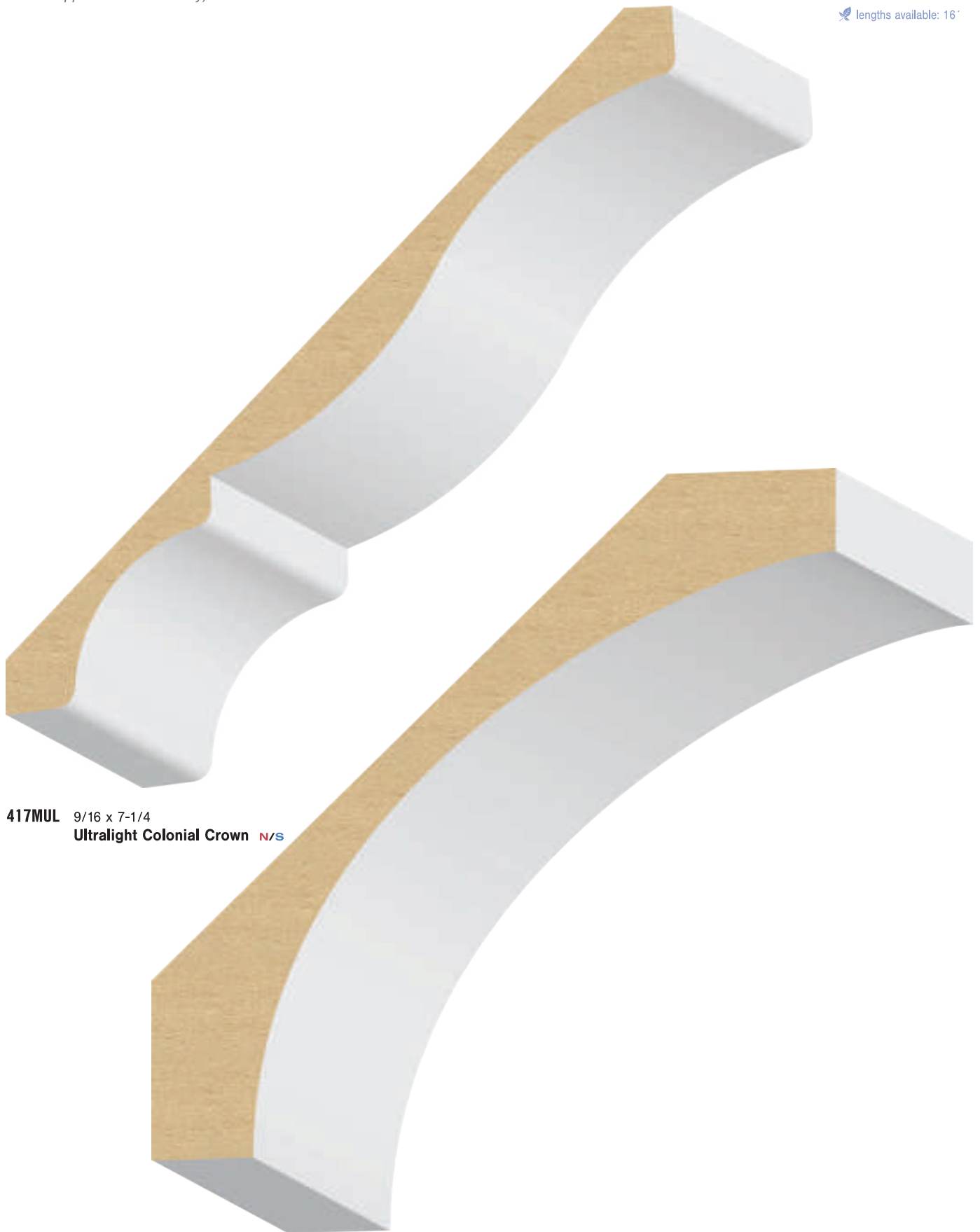

417MUL 9/16 x 7-1/4
Ultralight Colonial Crown N/S

444MUL-7 1-3/16 x 7-1/4
Ultralight Contemporary Crown N/S
 [FORMERLY 445MUL]



7-1/4" to 8" Crown Mold

lengths available: 16'

(items are approximate scale only)



465LDF-7 1-1/4 x 7-1/4
LDF King George Crown **S**

428MUL 1-1/16 x 8 **Ultralight Coronado/Georgian Crown** **N/S**



(items are approximate scale only)

8" to 8-1/2" Crown Mold

lengths available: 16'

410MUL-8 1 x 8
**Ultralight Large
Charleston Crown** N/S
[FORMERLY 450MUL]

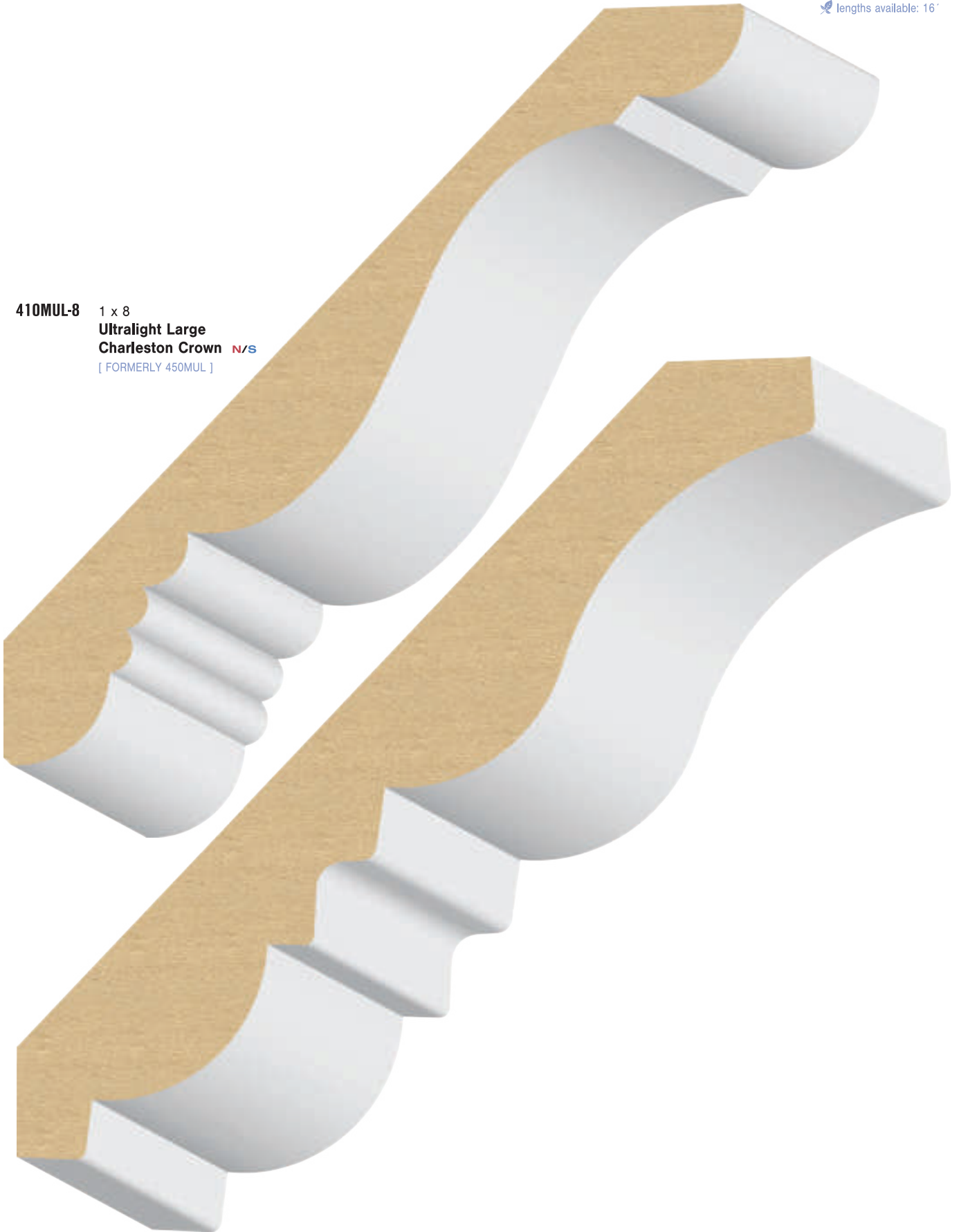

432MUL 1-3/16 x 8-1/2 **Ultralight Corona Crown** N/S



8-1/2" Crown Mold

lengths available: 16'

(items are approximate scale only)



454MUL 1-3/16 x 8-1/2 **Ultralight Del Mar Crown s**



(items are approximate scale only)

8-7/8" Crown Mold

lengths available: 16'



449MUL 11/16 x 8-7/8 **Ultralight Colonial Crown** N/S

11-1/4" Crown Mold

lengths available: 16'

(items are approximate scale only)

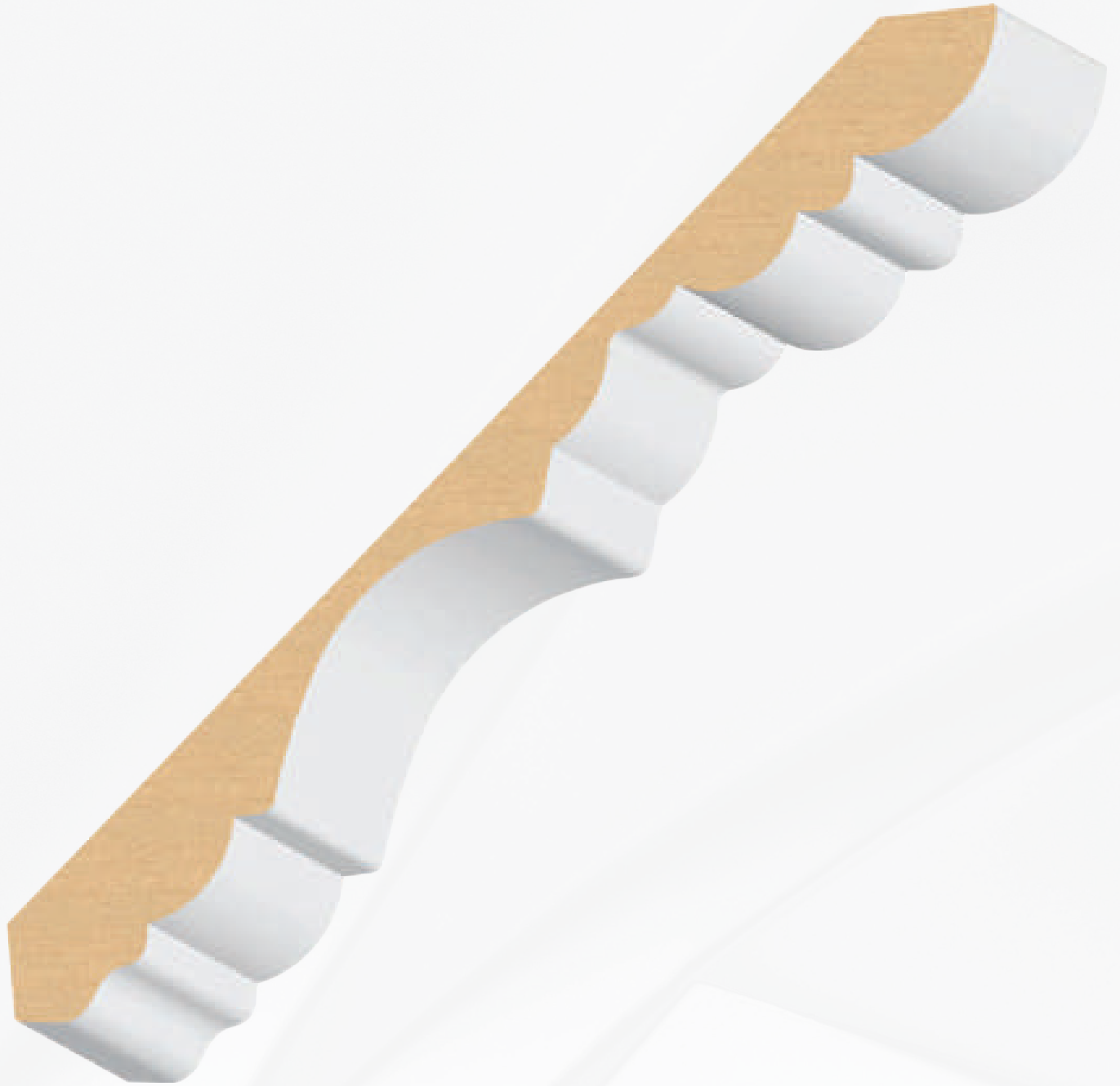

429MUL 1 x 11-1/4 **Ultralight Coronado/Georgian Crown** N/S

(NOT TO SCALE)



(items are approximate scale only)

Chair Rail



651MUL 9/16 x 2-1/2
Ultralight Chair Rail N/S



655MUL 9/16 x 2-5/8
Ultralight Colonial Chair Rail N/S



648MUL 1 x 3
Ultralight Bolection Chair Rail N/S



649MUL 3/4 x 3
Ultralight Bead & Barrel Chair Rail N/S



653MUL 11/16 x 3
Ultralight Colonial Chair Rail N/S



647MUL 1 x 3-1/2
Ultralight Malibu Chair Rail N/S



656MUL 5/8 x 4-1/2
Ultralight Traditional Chair Rail N/S



Panel Cap

lengths available: 16'

(items are approximate scale only)



739MUL 1-1/16 x 1-5/16
Ultralight Panel Cap N/S
 [with 1/4" x 11/16" Rab't]



738MUL 1-1/8 x 1-3/4
Ultralight Panel Cap N/S
 [with 5/16" x 5/8" Rab't]



733MUL 1-3/16 x 2
Ultralight Panel Cap N/S
 [with 3/4" Rab't]



737MUL 3/4 x 2
Ultralight Panel Cap N/S
 [with 1/4" x 1/2" Rab't]



729LDF 9/16 x 2-1/4
LDF Wainscot Cap S
 [with 3/8" Rab't]



734MUL 1 x 2-1/2
Ultralight Panel Cap N/S
 [with 3/8" Rab't]



740LDF 1 x 2-1/2
Ultralight Contemporary Cap N/S
 [with 5/8" Rab't]

flat astragal/panel mold

lengths available: 7' & 16'



646MUL 11/16 x 1-3/4
Ultralight Flat Astragal/Panel Mold N

660MUL 11/16 x 1-5/8
Ultralight Flat Astragal/Panel Mold S



Wainscoting

lengths available: 16'

(items are approximate scale only)



- 2001LDF** 3/8 x 3-1/2 LDF Flat T&G Wainscot N/S
- 2003LDF** 3/8 x 5-1/2 LDF Flat T&G Wainscot N/S



- 2000LDF** 3/8 x 3-1/2 LDF Beaded T&G Wainscot N/S
- 2002LDF** 3/8 x 5-1/2 LDF Beaded T&G Wainscot N/S



- 2005MUL** 1/4 x 7 Ultralight Beaded T&G Wainscot S
- 2005LDF** 3/8 x 7-1/4 LDF Beaded T&G Wainscot N



SINGLE NICKEL GAP

V-GROOVE

SINGLE NICKEL GAP

V-GROOVE

1 SIDE = V-GROOVE
1 SIDE = SINGLE NICKEL GAP

- 2007LDF** 5/8 x 5-1/2 LDF Reversible V-Groove/Nickel Gap T&G N/S
- 2008LDF** 5/8 x 7-3/8 LDF Reversible V-Groove/Nickel Gap T&G N/S

lengths available: 16'

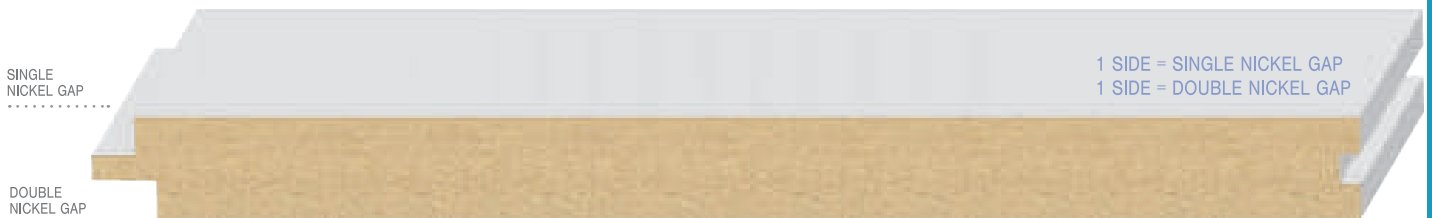

SINGLE NICKEL GAP

DOUBLE NICKEL GAP

1 SIDE = SINGLE NICKEL GAP
1 SIDE = DOUBLE NICKEL GAP

- 2009LDF** 5/8 x 7-3/8 LDF Single/Double Nickel Gap T&G Wainscot N/S

Hook

lengths available: 16'



15FB 9/16 x 3-1/4 **Fiberboard 1 Eased Edge Hookstrip** N/S

Cleat

lengths available: 16'



10FB 9/16 x 1-1/2 **Fiberboard 1 Eased Edge Cleat** N/S

(items are approximate scale only)

Window Stool

lengths available: 16'



Ultralight Primed

- PR990MUL** 11/16 x 4-3/4 **Ogee Stool** N
- PR992MUL** 11/16 x 5-1/4 **Ogee Stool** N
- PR993MUL** 11/16 x 6-1/2 **Ogee Stool** N
- PR994MUL** 11/16 x 7-1/4 **Ogee Stool** N
- PR999MUL** 1-3/16 x 8-1/4 **Ogee Stool** N

Primed LDF

- PR990LDF** 11/16 x 4-3/4 **Ogee Stool** N
- PR992LDF** 11/16 x 5-1/4 **Ogee Stool** N
- PR993LDF** 11/16 x 6-1/2 **Ogee Stool** N
- PR994LDF** 11/16 x 7-1/4 **Ogee Stool** N

Unprimed LDF

- 990LDF** 11/16 x 4-3/4 **Ogee Stool** N/S
- 991LDF** 11/16 x 6-3/4 **Ogee Stool** S
- 992LDF** 11/16 x 5-1/4 **Ogee Stool** N
- 993LDF** 11/16 x 6-1/2 **Ogee Stool** N
- 994LDF** 11/16 x 7-1/4 **Ogee Stool** N
- 999LDF** 1-1/4 x 8-1/4 **Ogee Stool** N



986LDF 11/16 x 4-3/4 **LDF Beveled Stool** S

987LDF 11/16 x 6-3/4 **LDF Beveled Stool** S



976LDF 1 x 4-3/4 **LDF Thick Beveled Stool** N/S

977LDF 1 x 7-1/4 **LDF Thick Beveled Stool** N/S

[FORMERLY 988LDF]

[FORMERLY 989LDF]



PR995MUL 1-3/16 x 8-1/4 **Bullnose Stool Primed** N
995LDF 1-1/4 x 8-1/4 **Bullnose Stool Unprimed** N

5/8"



(items are approximate scale only)

Wall Cap

lengths available: 16'



996LDF 11/16 x 7-1/4 **Double Ogee Cap Primed N**

S4S

lengths available: 16'



E2E Wall Cap

lengths available: 16'

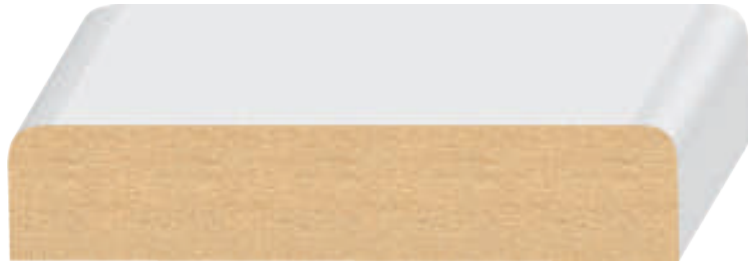

Primed Ultralight

Product	Dimensions	Material	Finish	Lengths available
713MUL	11/16 x 1-1/2	S4S	N/S	16', 17'
714MUL	11/16 x 2-1/2	S4S	N/S	8', 16', 17'
715MUL	11/16 x 3-1/2	S4S	N/S	8', 10', 12', 16', 17'
750MUL	11/16 x 5-1/2	S4S	N/S	8', 10', 12', 16', 17'
751MUL	11/16 x 7-1/4	S4S	N/S	8', 10', 12', 16'
752MUL	11/16 x 9-1/4	S4S	N/S	8', 10', 12', 16'
753MUL	11/16 x 11-1/4	S4S	N/S	8', 10', 12', 16'

Primed LDF

Product	Dimensions	Material	Finish	Lengths available
713LDF	11/16 x 1-1/2	S4S	N/S	16', 17'
714LDF	11/16 x 2-1/2	S4S	N/S	8', 16', 17'
715LDF	11/16 x 3-1/2	S4S	N/S	8', 10', 12', 16', 17'
750LDF	11/16 x 5-1/2	S4S	N/S	8', 10', 12', 16', 17'
751LDF	11/16 x 7-1/4	S4S	N/S	8', 10', 12', 16'
752LDF	11/16 x 9-1/4	S4S	S	8', 10', 12', 16'
753LDF	11/16 x 11-1/4	S4S	N/S	8', 10', 12', 16'

Primed Ultralight

145MUL	3/4 x 4-1/2	2 Round Edge Craftsman Casing	N/S
--------	-------------	-------------------------------	-----

Primed LDF

Product	Dimensions	Material	Finish	Lengths available
1098LDF	11/16 x 1-1/2	E2E	N/S	16'
1099LDF	11/16 x 2-1/2	E2E	N/S	16'
1100LDF	11/16 x 3-1/2	E2E	N/S	16'
1101LDF	11/16 x 5-1/2	E2E	N/S	16'
1102LDF	1-1/4 x 5-1/2	E2E	S	16'
1103LDF	11/16 x 7-1/4	E2E	N/S	16'
1104LDF	1-1/4 x 7-1/4	E2E	N/S	16'
1105LDF	11/16 x 6-1/2	E2E	S	16'
1106LDF	11/16 x 11-1/4	E2E	N/S	16'
1107LDF	1-1/4 x 11-1/4	E2E	N/S	16'
1108LDF	1-1/16 x 3-1/2	E2S	N/S	16'

Primed MUL (Ultralight)

Product	Dimensions	Material	Finish	Lengths available
1098MUL	11/16 x 1-1/2	E2E	S	16'
1099MUL	11/16 x 2-1/2	E2E	S	16'
1100MUL	11/16 x 3-1/2	E2E	S	16'
1101MUL	11/16 x 5-1/2	E2E	S	16'
1103MUL	11/16 x 7-1/4	E2E	S	16'
1105MUL	11/16 x 6-1/2	E2E	S	16'
1107MUL	1-1/4 x 11-1/4	E2E	S	16'
1108MUL	1-1/16 x 3-1/2	E2S	S	16'



MDF Shelving

(items are approximate scale only)

✂ lengths available: 10' & 16'



Unprimed - Bullnose Edge Shelving

11MDF-BN	11/16 x 11-1/4	16'	N/S
12MDF-BN	11/16 x 15-1/4	16'	S
16MDF-BN	11/16 x 15-1/4	16'	N



Unprimed - Flat Edge Shelving

11MDF-F	11/16 x 11-1/4	16'	N
16MDF-F	11/16 x 15-1/4	16'	N
13MDF-F	11/16 x 23-1/4	16'	S
30MDF-F	11/16 x 30-1/2	10' or 16'	N



Unprimed - 2 Eased Edge Shelving

11MDF-2E	11/16 x 11-1/4	16'	S
12MDF-2E	11/16 x 15-1/4	16'	S

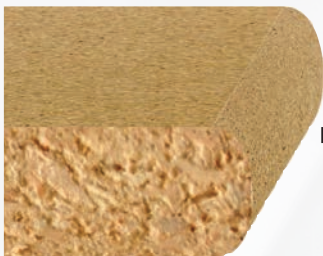

BN (Bullnose Face) **N/S**

Bullnosed Particle Board Shelving with Taped Edge

11PB	5/8 x 11-1/4	S	11PB-BN	3/4 x 11-1/4	N
12PB	5/8 x 15-1/4	S	16PB-BN	3/4 x 15-1/4	N
13PB	5/8 x 23-1/4	S	24PB-BN	3/4 x 23-1/4	N
16PB	3/4 x 11-1/4	S			
17PB	3/4 x 15-1/4	S			
18PB	3/4 x 23-1/4	S			

(items are approximate scale only)

Interior Door Jambs

lengths available: 7' & 17'



INTERIOR DOOR JAMBS			
	Primed MDF		
SIZE	6/8	8/0	17' LINEAL
3-9/16 <i>N/S</i>	N/A	N/A	N/A
4-9/16 <i>N/S</i>	4916MI6	4916MI8	4916MIL
4-13/16 <i>N/S</i> (4-3/4)	434MI6	434MI8	434MIL
5-1/4 <i>N/S</i>	514MI6	514MI8	514MIL
6-9/16 <i>N/S</i>	6916MI6	6916MI8	6916MIL
7-1/4 <i>N/S</i>	714MI6	714MI8	714MIL

Kerfing for bullnose is available on all jamb sizes and species and custom size odd wall widths available upon request.

Interior Door Jamb Specs

- ☞ 1 1/16" Thick
- ☞ Lineal - 17' = MDF
- ☞ Dado depth is 3/8"
- ☞ 5 pair per bundle

NOR CAL / CENTRAL CAL / AZ SPECS

- ☞ 6/8 = 81" Below Dado
- ☞ 8/0 = 97" Below Dado

SO CAL / SO NV SPECS

- ☞ 6/8 = 80-5/8" Below Dado
- ☞ 8/0 = 96-5/8" Below Dado



Big Ideas



VG Doug Fir & Redwood

STRONG AND DURABLE INSIDE OR OUT



VG Doug Fir is identified by its beautiful up and down vertical grains and red tones. VG Doug Fir can be clear coated (see above picture), stained or painted and is a great choice for homes with a craftsman, contemporary or rustic style.

Redwood's rot resistant properties make it ideal for exterior applications. Durable and said to be resistive to certain wood eating mites, Redwood is high in moisture and may darken over time. Redwood, maintained over time, looks best with paint or stain.



section contents

Astragal	265
Base & Base Shoe.....	259
Brick Mould	269
Bullnose Stepping	266
Casing.....	257
Corner Mold	271
Cove	271
Crown.....	262
Door Stop Header	259
Exterior Door Frames.....	270
Exterior Molds	272
Full Round.....	269
Gutter Mould.....	272
Handrail	275
Interior Door Jambs	270
Lattice	271
Ovolo Sticking.....	264
Panel Cap	264
Quarter Round	271
S4S.....	266, 271
Shingle Mould	273
Standard Frame for 1-3/4" Doors.....	270
Stool	266
Stucco Mold	269
T&G Flooring.....	266
Wainscot.....	264
Watertable	273
Wiggle Mould.....	274
Window Sill	274

VG Doug Fir & Redwood

I/E

DESIGN STYLES

TRADITIONAL | RUSTIC | CRAFTSMAN | CONTEMPORARY

**JANKA
HARDNESS**
(POUNDS-FORCE)

660/450

CUT LIST

Determining How Much You Need

- 1 Measure the room at the height or length where each moulding goes to determine the number and the length of the pieces you'll need.
- 2 VG Doug Fir & Redwood moulding is available in 3' to 16' lengths, with some profiles available in 20'. Add your footage and multiply that number by 1.1. The result is the total footage needed plus ten percent for waste. Perform this step for each type of moulding, base, chair rail and crown, separately.
- 3 When ordering casing for doors, order 7' or 8' lengths for 6/8 doors and 9' or 10' lengths for 8/0 doors.
- 4 Most door heads are cut from random lineal footage. Always cut the longest pieces first: door legs, window legs, long window heads and sills, and then door heads.
- 5 The most important tool when working with moulding is **patience**. Remember the old adage, measure twice and cut once. Never try to rush trim work.
- 6 Lengths ordered may not always be available. Always verify availability when ordering.

ALWAYS TEST TO MAKE SURE YOUR MEASURING TOOLS ARE ACCURATE. IF YOU ARE WORKING WITH A HELPER, TAKE A MEASUREMENT WITH ONE TOOL WHILE YOUR HELPER MEASURES WITH ANOTHER AND COMPARE YOUR RESULTS.

FINISHING

REDWOOD

Sand lightly before finishing to remove dirt, hammer marks or other blemishes. Remove grease spots with a solvent such as mineral spirits or turpentine prior to sanding.

If nails are countersunk, nail holes can be filled with putty (if a paint or heavy-bodied stain is to be used), or with a non-oily filler (if a natural or light stain finish is planned). Wood fillers are available in a variety of tones, and fillers can be tinted with pigments to match the color of the wood. After filling, sand flat and dust the surface before finishing.

Finish with Clear Lacquer, Alkyd Resin & Polyurethane Varnishes, Pigmented Finishes, Wax (except kitchen and bathroom) or Alkyd Resin Sealers & Danish Oil (except bathroom).

DOUG FIR

Attach 100-grit sandpaper to a hand-sanding block. Stroke the surface of the wood, using short strokes until the sandpaper produces dust with a slightly coarse texture. Sand forward 4 inches and backward 3 inches. Keep moving forward in a single line with the woodgrain. When you reach the end of the wood, start another row overlapping the first line by 1 inch.

Dust off the wood with a soft cloth. You want a dull surface without any shiny spots when finished. The dull appearance means you have sufficiently opened the pores on the wood.

Dip a folded cotton cloth into an open can of stain. Wipe the surface of the wood with the wet cloth until the wood is consistently wet with stain.

Wipe the stain off with a dry, cotton cloth. Vigorously wipe the wood, using circular motions. When the wood looks dry, wipe it down one more time, using strokes parallel to the grain of the wood. Allow the stain to dry according to the manufacture's instructions. Allow oil stain to dry for at least 72 hours.

HELPFUL HINTS

- ❖ **Cope all inside corners** for baseboard, chair rail, and crown moulding.
- ❖ **When mitering wide mouldings**, and for all exterior trim work, use biscuits or dominoes to reinforce miters.
- ❖ **CHECK the moisture content of all wood moulding:** for interior trim, the MC should be 8-10%; for exterior trim the MC should be 12-14%. For every 4% change in MC, wood moves 1%.
- ❖ Exterior trim: use **'splitless' siding nails**—they have blunt tips and prevent wood from splitting.
- ❖ **Pre-drill:** for any nails driven closer than 3/4" to the edge of a board.
- ❖ **For painted trim:** caulk over any nails that are overdriven—countersunk too deep.
- ❖ **Last mouldings to be installed:** base, shoe and quarter rounds.
- ❖ **Chair rails** can be installed 32" to 36" from the floor.
- ❖ Use Rosettes and Plinth blocks at the corners of windows and doors to **eliminate the mitering process**.
- ❖ **After installation is complete:** caulk and/or putty all gaps and nail holes.
- ❖ Use any brand of spray furniture polish on saw blade as a **lubricant for easier cutting**.



FOR BEST FINISH PERFORMANCE, INTERIOR WOOD SHOULD BE CLEAN AND DRY. FOLLOW FINISH MANUFACTURER'S APPLICATION INSTRUCTIONS. DO NOT MIX INCOMPATIBLE FINISHES. WORK IN A WELL-VENTILATED ROOM.



2-1/4" to 3-1/4" Casing

lengths available: 6' thru 16'

(items are approximate scale only)



HC150VG 1-5/16 x 2-1/4 VG Fir Door Header Cap N/S



120VG 9/16 x 2-1/4 VG Fir 2 Round Edge Casing N/S



141VG 5/8 x 2-1/4 VG Fir Moulded Casing N



152VG 11/16 x 2-1/4 VG Fir Colonial/#356 Casing N/S



108VG 5/8 x 2-1/2 VG Fir #711 Casing S



114VG-3 5/16 x 3-1/4 VG Fir 2 Eased Edge Mullion Casing N/S



172VG-3 11/16 x 3-1/4 VG Fir Contemporary Casing N/S



176VG 5/8 x 3-1/4 VG Fir Moulded Casing N/S



3-1/2" to 5-1/2" Casing

(items are approximate scale only)

✦ lengths available: 6' thru 16'



139VG 11/16 x 3-1/2 VG Fir 2 Round Edge Casing *N/S*



156VG 11/16 x 3-1/2 VG Fir Shasta Casing *N*



140VG 13/16 x 4-1/2 VG Fir Tuscany Casing *N*



114VG-5 5/16 x 5-1/2 VG Fir 2 Eased Edge Mullion Casing *N/S*

(items are approximate scale only)

Door Stop Header

lengths available: 6' thru 16'



201VG 7/16 x 1-1/4
VG Fir 1 Round Edge Stop **N**



209VG 1/2 x 1-1/2
VG Fir 1 Round Edge Stop **N/S**

2-1/4" to 3-1/4" Base & Base Shoe

lengths available: 6' thru 16'



300BVG 7/16 x 11/16
VG Fir Base Shoe **N/S**

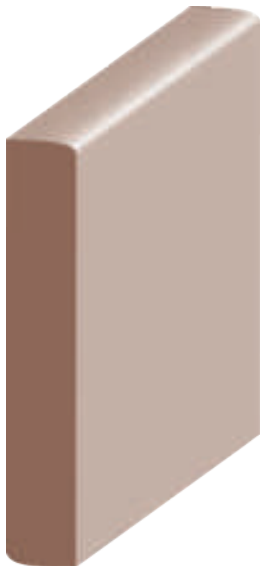

R304VG-2 3/8 x 2-1/4
VG Fir Reversible Base **N/S**



310VG 1/2 x 2-1/2
VG Fir #711 Base **S**

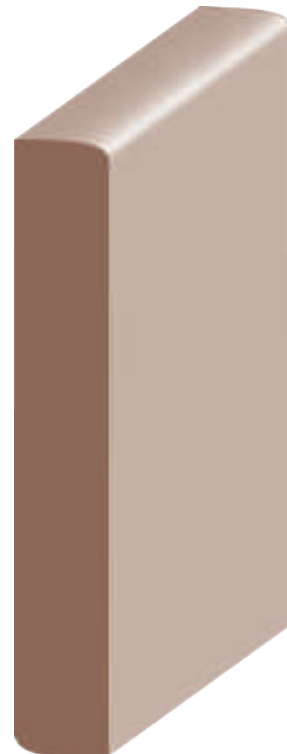

R306VG-3 1/2 x 3-1/4
VG Fir Reversible Base **N/S**



3-1/4" to 4-1/2" Base

lengths available: 7' and 17'

(items are approximate scale only)

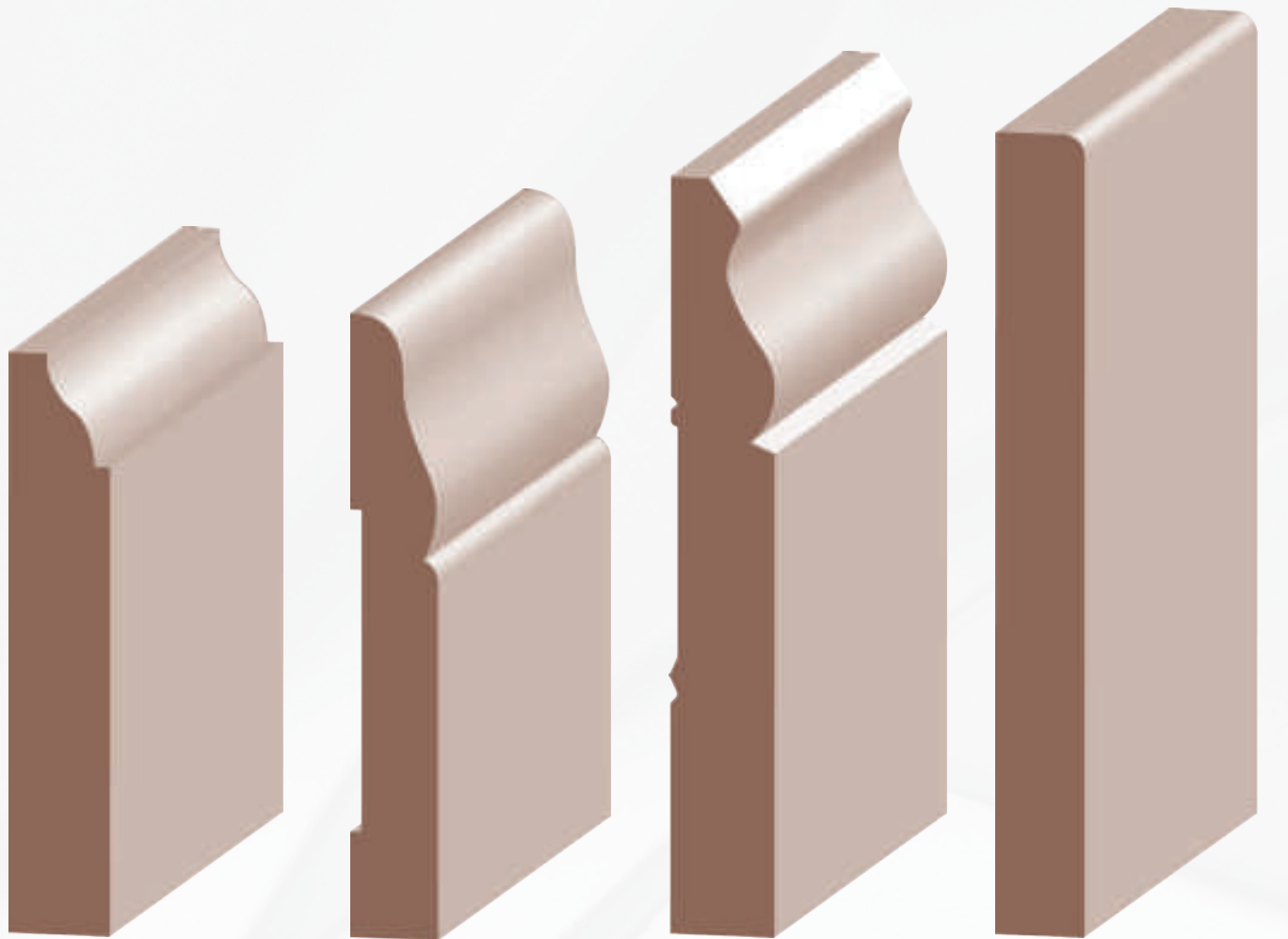

314VG-3 9/16 x 3-1/4
 VG Fir
 Coronado/#623 Base *N/S*

311VG 1/2 x 3-1/2
 VG Fir #711 Base *S*

328VG-4 1/2 x 4-1/2
 VG Fir
 Colonial Base *N/S*

387VG-4 1/2 x 4-1/2
 VG Fir 1 Eased Edge
 Craftsman Base *N/S*



(items are approximate scale only)

5-1/4" to 7-1/4" Base

lengths available: 6' thru 16'



328VG-5 1/2 x 5-1/4
VG Fir
Colonial Base *N/S*

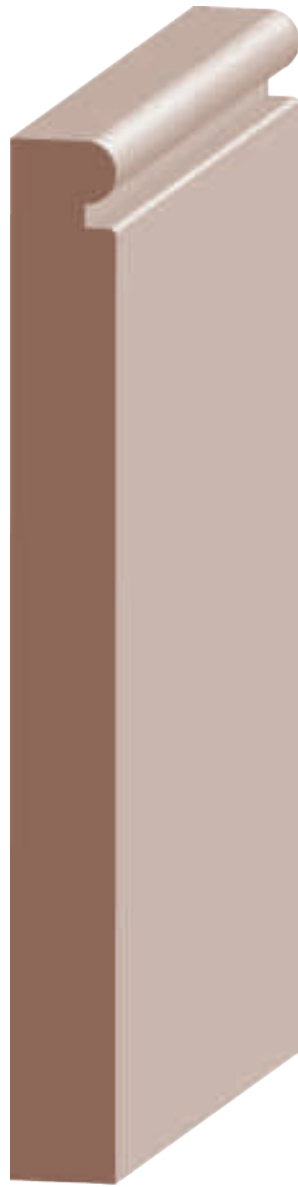

372VG-5 1/2 x 5-1/2
VG Fir
Contemporary Base *N/S*

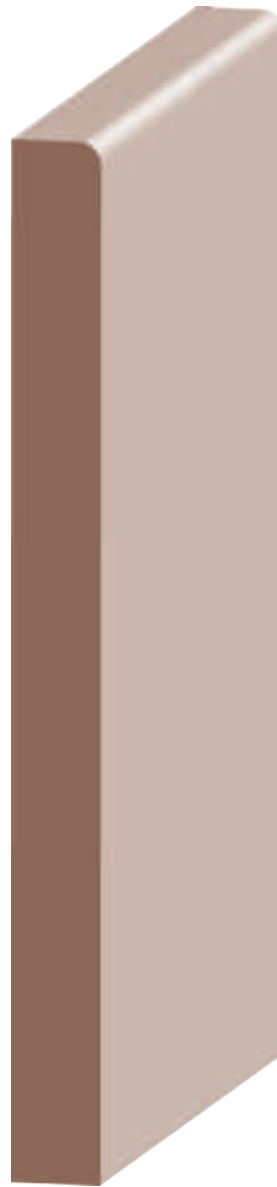

387VG-5 1/2 x 5-1/2
VG Fir 1 Eased Edge
Craftsman Base *N/S*



375VG-7 11/16 x 7-1/4
VG Fir
Tuscany Base *N*



4-1/4" to 4-5/8" Crown

lengths available: 7' and 17'

(items are approximate scale only)

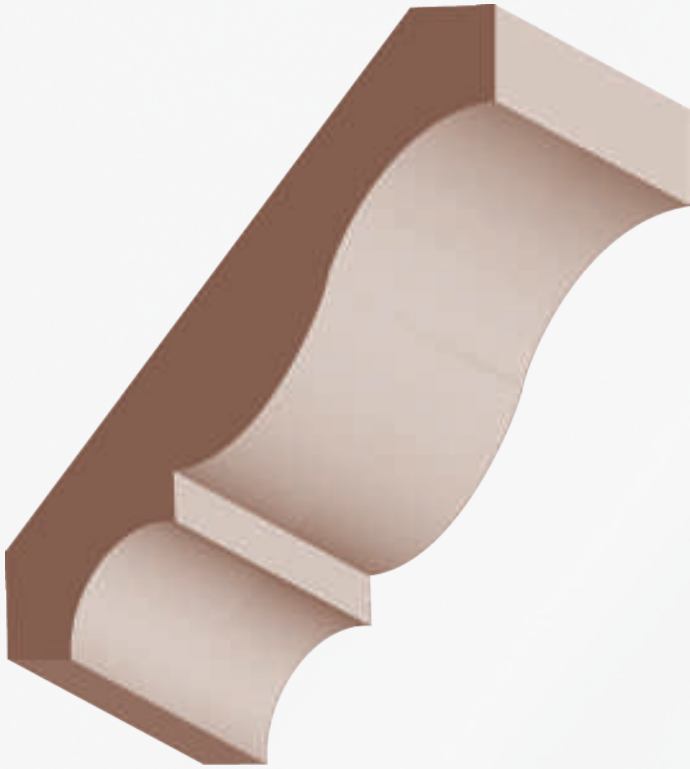

406VG 9/16 x 4-1/4
VG Fir Colonial Crown N/S

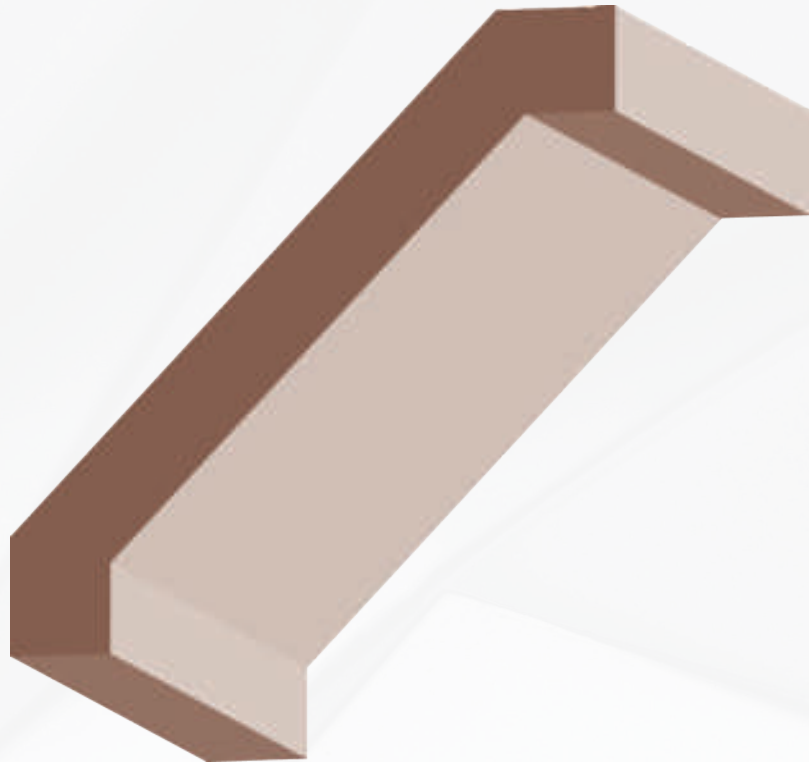

460VG 11/16 x 4-5/8
VG Fir Craftsman Crown N/S

(items are approximate scale only)

5-1/4" to 7-1/4" Crown

lengths available: 7' and 17'

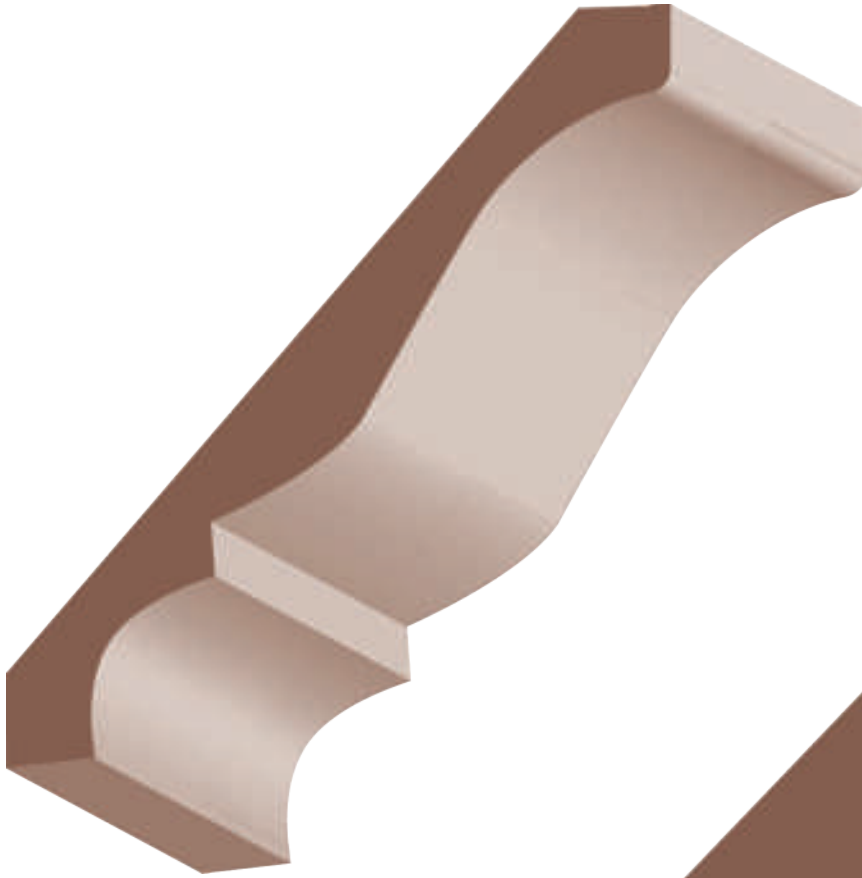

414VG 9/16 x 5-1/4
VG Fir Colonial Crown **N/S**

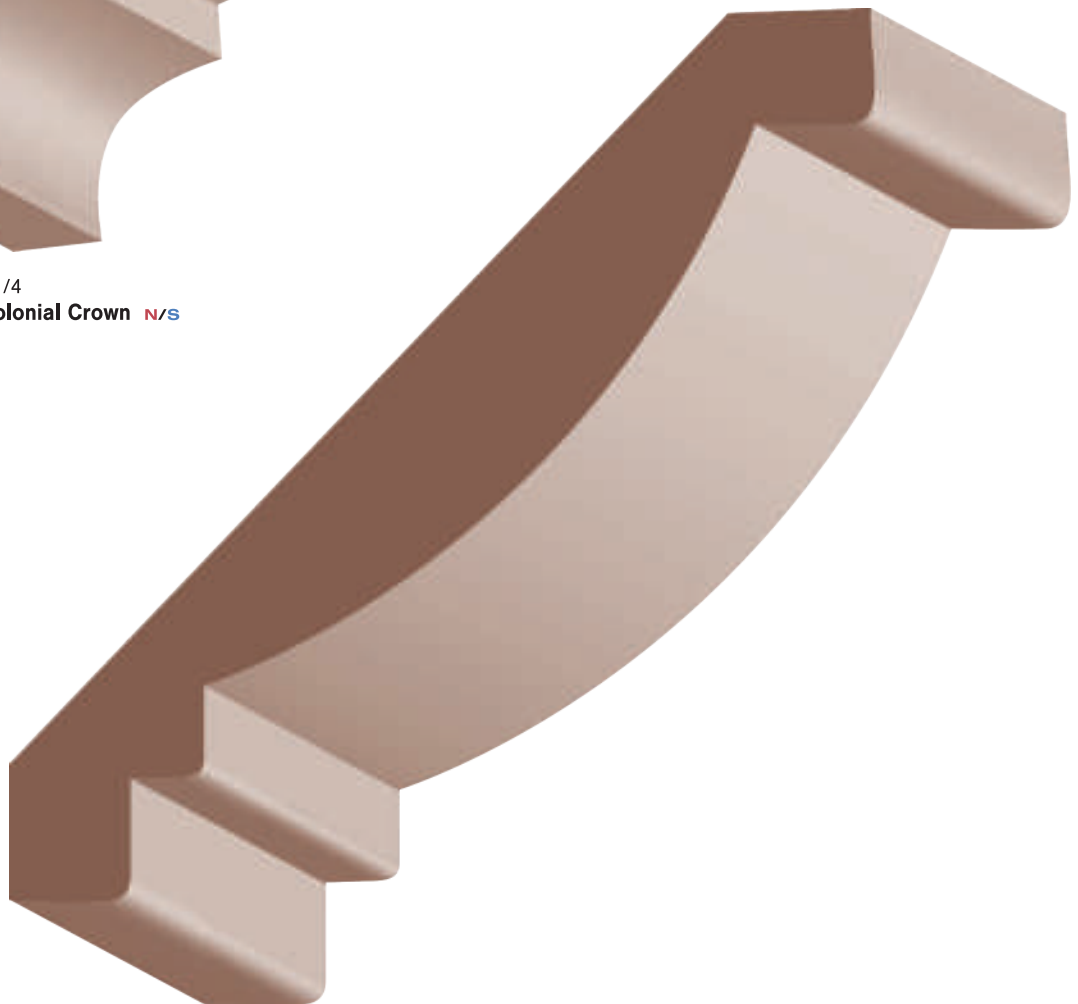

462VG 1 x 7-1/4 VG Fir Tahoe Crown **N/S**



Quarter Round / Cove / Ovolo Sticking

(items are approximate scale only)

lengths available: 7' and 17'



504VG 11/16 x 11/16
VG Fir Quarter Round *N/S*



523VG 11/16 x 11/16
VG Fir Cove *N/S*



599VG 3/8 x 3/8
VG Fir Ovolo Sticking *N/S*

Panel Cap / Wainscot



620VG 11/16 x 2-1/8
VG Fir Coronado Wainscot Cap *N/S*
[with 3/8" Rab't]

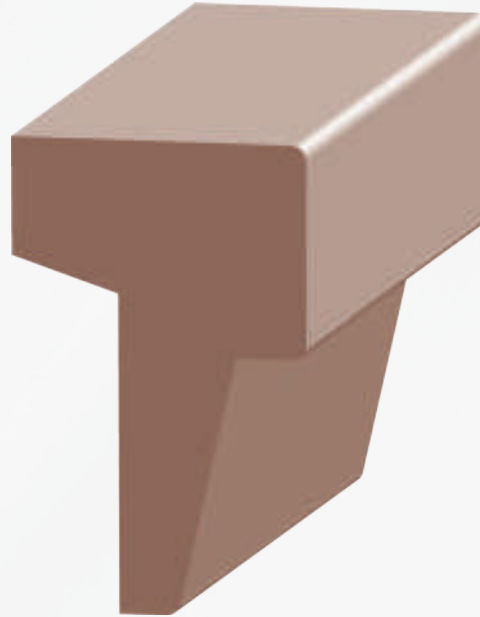

623VG 1-9/16 x 2-1/2
VG Fir Craftsman Cap *N/S*
[with 9/16" Rab't]



R2000VG 3/8 x 3-1/4 VG Fir Reversible Beaded/Flat T&G Wainscot *N/S*

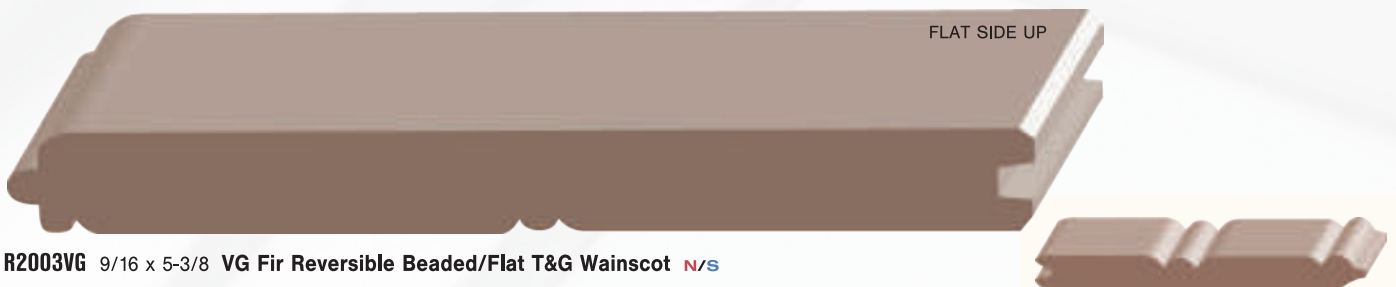

R2003VG 9/16 x 5-3/8 VG Fir Reversible Beaded/Flat T&G Wainscot *N/S*

Astragal

lengths available: 7' and 17'

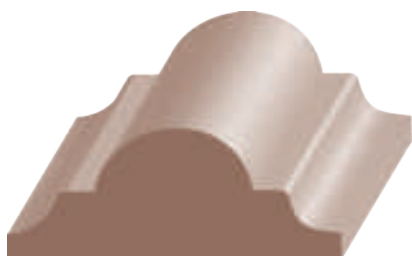

646VG 11/16 x 1-5/8 VG Fir Flat Astragal/Panel Mold **N**

660VG 3/4 x 1-5/8 VG Fir Flat Astragal/Panel Mold **S**

lengths available: 7' and 8' only

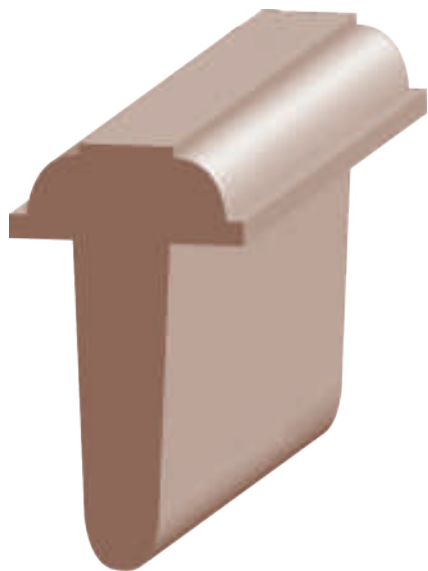

662VG 1-1/4 x 2 VG Fir T-Astragal for 1-3/8" Door **N/S**

lengths available: 7' and 8' only

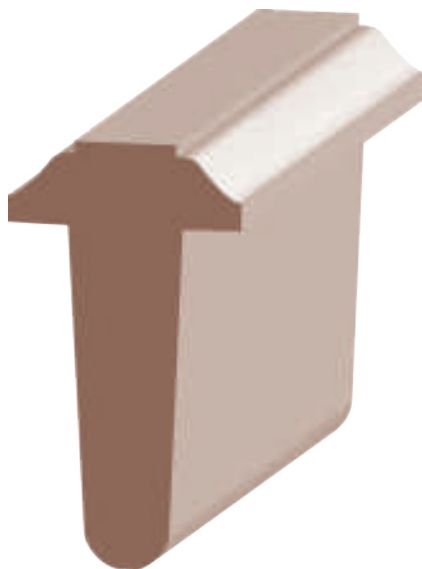

661VG 1-1/4 x 2-1/4 VG Fir T-Astragal for 1-3/4" Door **N/S**

lengths available: 7', 8' and 12' only

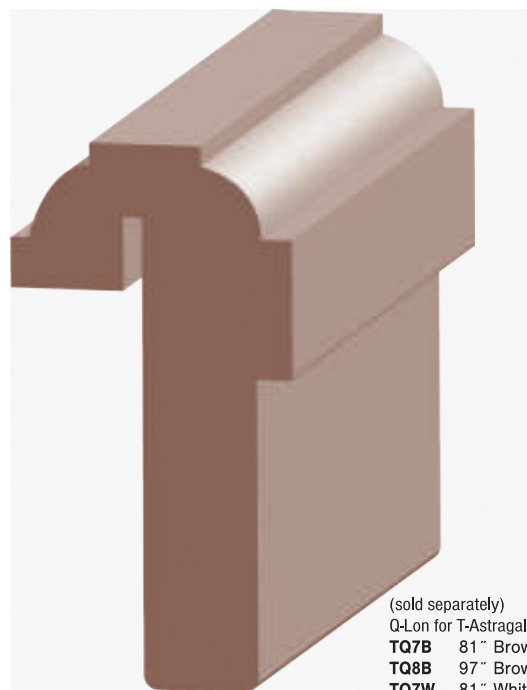

663VG 1-1/2 x 2-7/8 VG Fir T-Astragal w/Weather Strip Kerf for 1-3/4" Door **N/S** (Q-Lon sold separately)

663BVG 1-5/8 x 3 Thick VG Fir T-Astragal w/Weather Strip Kerf for 1-3/4" Door **S**

lengths available: 7', 8' and 12' only

(sold separately)
Q-Lon for T-Astragal
TQ7B 81" Brown
TQ8B 97" Brown
TQ7W 81" White
TQ7W 81" White



664VG 1-1/2 x 3-3/8 VG Fir T-Astragal w/Weather Strip Kerf for 2-1/4" Door **N/S** (Q-Lon sold separately)

lengths available: 7', 8' and 12' only

Q-Lon for T-Astragal
TQ7B 81" Brown
TQ8B 97" Brown
TQ7W 81" White
TQ7W 81" White



667VG 1-1/2 x 3-1/8 VG Fir Contemporary T-Astragal w/Weather Strip Kerf for 1-3/4" Door **N/S** (Q-Lon sold separately)

lengths available: 7' and 8' only

Stool

(items are approximate scale only)

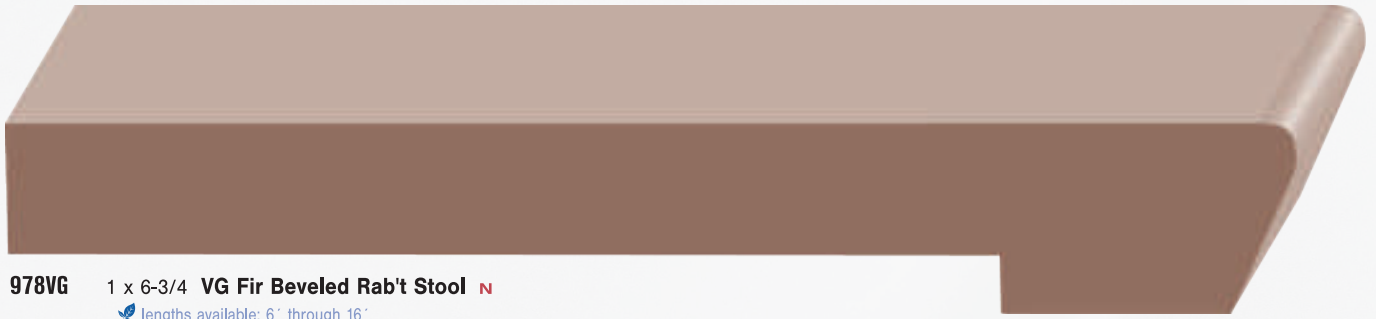

978VG 1 x 6-3/4 **VG Fir Beveled Rab't Stool** **N**
 lengths available: 6' through 16'

Bullnose Stepping and VG T&G Flooring



890VG 1-1/4 x 11-1/4 **VG Fir Bullnose Stepping** **N**
 (5/4 x 12)
 lengths available: 6' through 16'



FL1X4VG 3/4 x 3-1/2 **VG Fir T&G Flooring** **N**

S4S



DUTCHVG 1-1/4 x 3-1/2 **VG Fir S4S** **S**

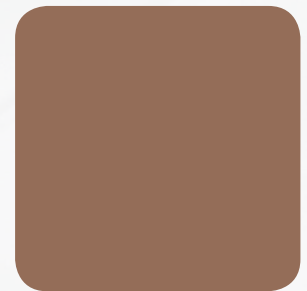

717VG 1-1/2 x 1-1/2 (2x2) **VG Doug Fir S4S** **N**
725VG 3-1/2 x 3-1/2 (4x4) **VG Doug Fir S4S** **N**

713VG	3/4 x 1-1/2	(1x2)	VG Doug Fir S4S	N	755VG	1-1/2 x 3-1/2	(2x4)	VG Doug Fir S4S	N
714VG	3/4 x 2-1/2	(1x3)	VG Doug Fir S4S	N	756VG	1-1/2 x 5-1/2	(2x6)	VG Doug Fir S4S	N
715VG	3/4 x 3-1/2	(1x4)	VG Doug Fir S4S	N/S	757VG	1-1/2 x 7-1/4	(2x8)	VG Doug Fir S4S	N
750VG	3/4 x 5-1/2	(1x6)	VG Doug Fir S4S	N/S	759VG	1-1/2 x 9-1/4	(2x10)	VG Doug Fir S4S	N
751VG	3/4 x 7-1/4	(1x8)	VG Doug Fir S4S	N/S	758VG	1-1/2 x 11-1/4	(2x12)	VG Doug Fir S4S	N
752VG	3/4 x 9-1/4	(1x10)	VG Doug Fir S4S	N/S					
753VG	3/4 x 11-1/4	(1x12)	VG Doug Fir S4S	N/S					

(items are approximate scale only)

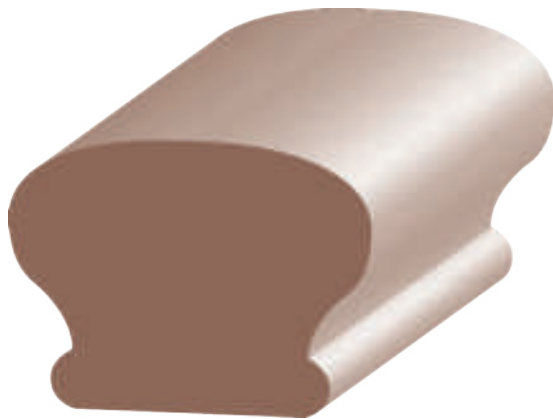

F955 1-7/16 x 1-15/16 **Doug Fir Mushroom Handrail** N
F956 1-7/16 x 2-3/8 **Doug Fir Mushroom Handrail** N
F956FJ 1-7/16 x 2-3/8 **FJ Doug Fir Mushroom Handrail** N
 + Trimbacks (lengths other than 16')

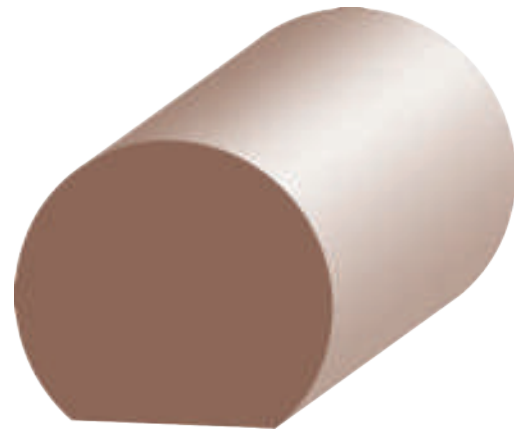

F951FJ 1-1/2 x 1-11/16
FJ Doug Fir Flat Bottom Handrail N
 + Trimbacks (lengths other than 16')

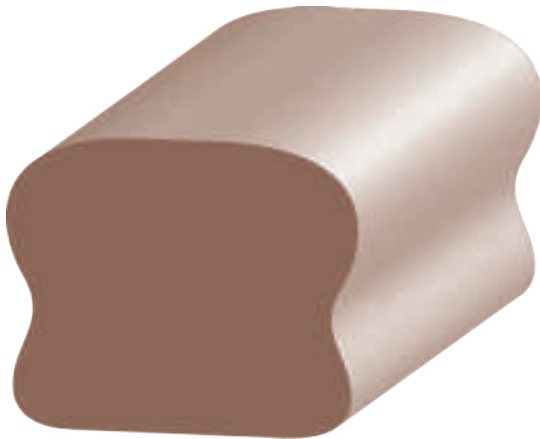

F926 1-1/2 x 1-7/8 **Doug Fir Small Handrail** S

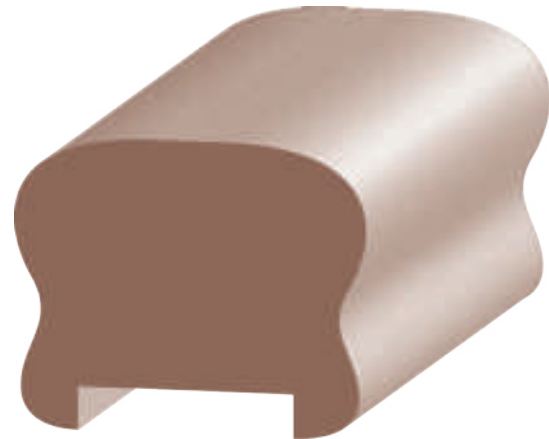

F926PL 1-1/2 x 1-7/8 **Doug Fir Small Handrail** S
 with 1/4 x 1-1/4 Plow



F932 1-1/2 x 1-7/8 **Doug Fir Small #6010 Handrail** S



F932PL 1-1/2 x 1-7/8 **Doug Fir Small #6010 Handrail** S
 with 1/4 x 1-1/8 Plow

Handrail

(items are approximate scale only)

✂ lengths available: 8' through 20'

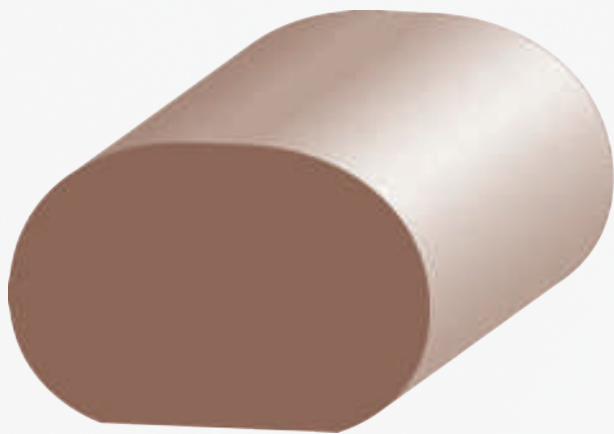

F927 1-1/2 x 2-1/4 Doug Fir Oval Handrail **s**

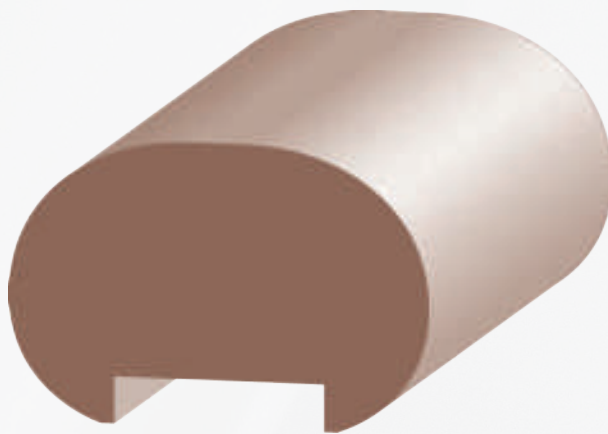

F927PL 1-1/2 x 2-1/4 Doug Fir Oval Handrail **s**
with 1/4 x 1-1/8 Plow

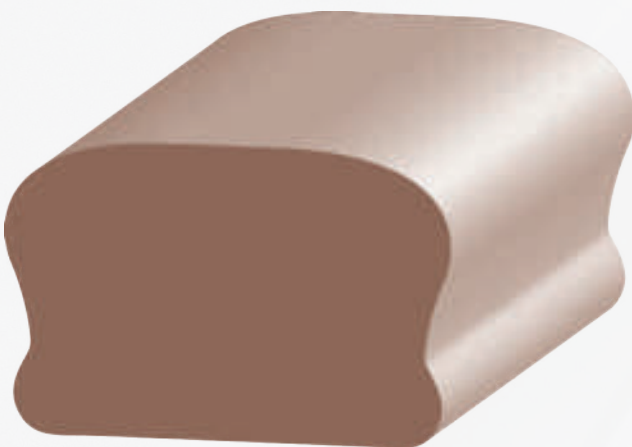

F925 1-1/2 x 2-3/8 Doug Fir Standard Handrail **s**

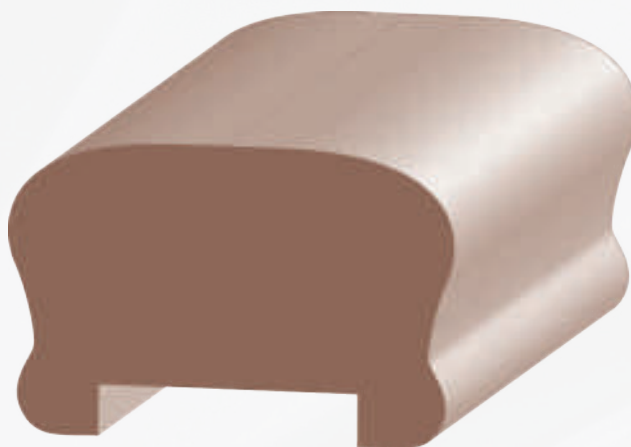

F925PL 1-1/2 x 2-3/8 Doug Fir Standard Handrail **s**
with 1/4 x 1-1/4 Plow

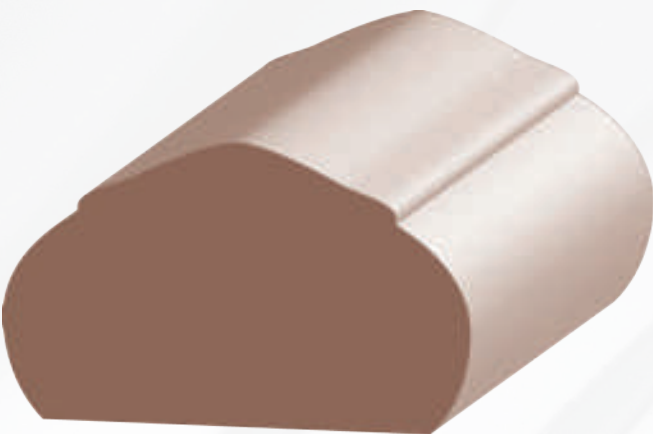

F928 1-1/2 x 2-1/2 Doug Fir 'B' Mushroom Handrail **s**

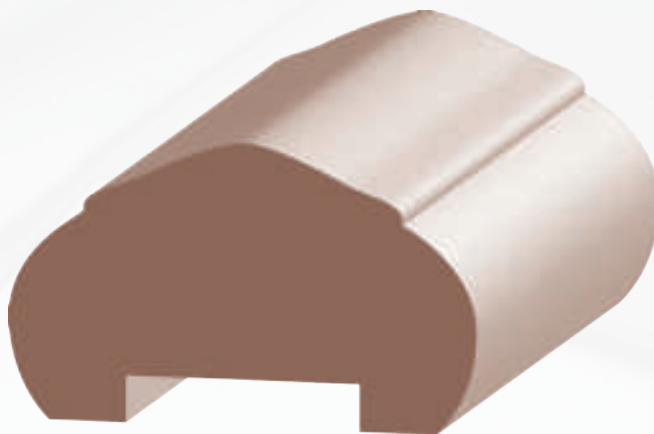

F928PL 1-1/2 x 2-1/2 Doug Fir 'B' Mushroom Handrail **s**
with 1/4 x 1-1/4 Plow



(items are approximate scale only)

Brick Mould / Stucco Mold

 lengths available: 6' thru 20'

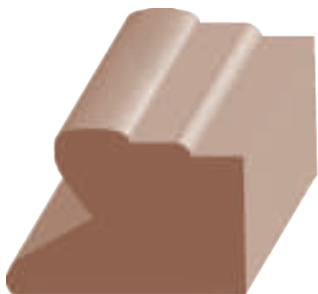

953VG 7/8 x 1-1/4 VG Fir Stucco Mold **S**



833VG 11/16 x 1-1/2 VG Fir Stucco Mold **N**

 lengths available: 7' and 17'

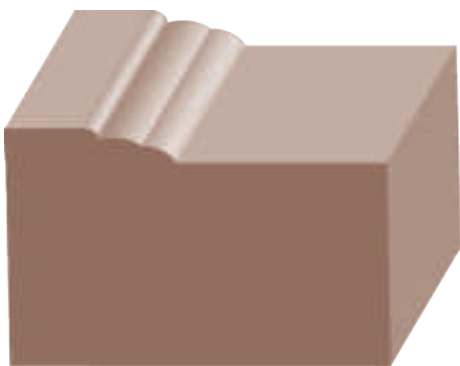

612AVG 1-1/4 x 2 VG Fir #180 Eastern Brick Mould **N/S**
without Stucco Key



612BVG 1-1/4 x 2 VG Fir #180 Eastern Brick Mould **N/S**
with Stucco Key

Full Round

 lengths available: solid fir 6'-20' / fj fir 16'+ trimbacks

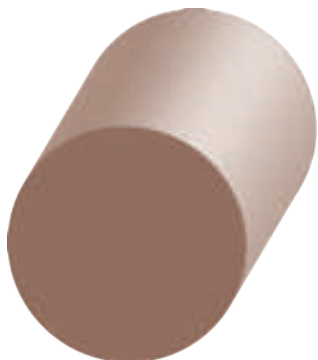

Doug Fir Full Round
F800 3/4 **S**
F806 1/2 **S**
F801 1 **S**

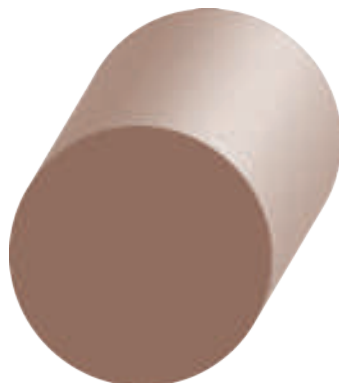

Doug Fir Full Round
F802 1-1/4 **N/S**
F803 1-3/8 **N/S**
F804 1-5/8 **N/S**
F805 1-7/8 **N/S**

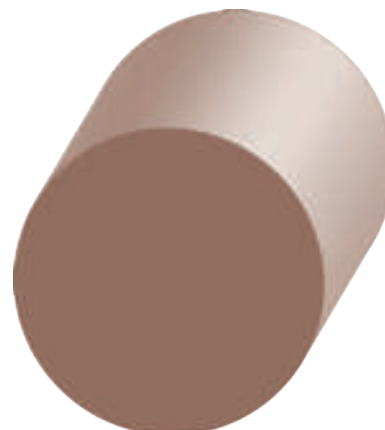

FJ Doug Fir Full Round
F802FJ 1-1/4 **N**
F804FJ 1-1/2 **N**



Weatherstrip Kerfed Exterior Door Frames

lineal pairs available in 6/8 and 8/0; all 6" through 16"

(items are approximate scale only)

ENGINEERED EXTERIOR DOOR FRAMES				
Weatherstrip Kerfed for 1/2" x 2-1/8" Door Rab't.				
SELECT CORRECT PART NUMBER BASED ON SPECIES/LOCATION				
SIZE	SPECIE	6/8 PRS.	8/0 PRS.	LINEAL (SOLID VG FIR)
4-1/8"	Flat Grain Fir VG Fir	418WFGE6 418WVGE6	418WFGE8 418WVGE8	418WFGL 418WVGL
4-5/8"	Flat Grain Fir VG Fir	458WFGE6 458WVGE6	458WFGE8 458WVGE8	458DFGL 458WVGL
5-1/4"	Flat Grain Fir VG Fir	514WFGE6 514WVGE6	514WFGE8 514WVGE8	514WFGL 514WVGL
6-1/8"	Flat Grain Fir	618WFGE6	618WFGE8	618WFGL
6-9/16"	Flat Grain Fir	618WFGE6	618WFGE8	618WFGL
6-5/8"	VG Fir	658WVGE6	658WVGE8	658WVGL
7-1/4"	Flat Grain Fir VG Fir	714WFGE6 714WVGE6	714WFGE8 714WVGE8	714WFGL 714WVGL

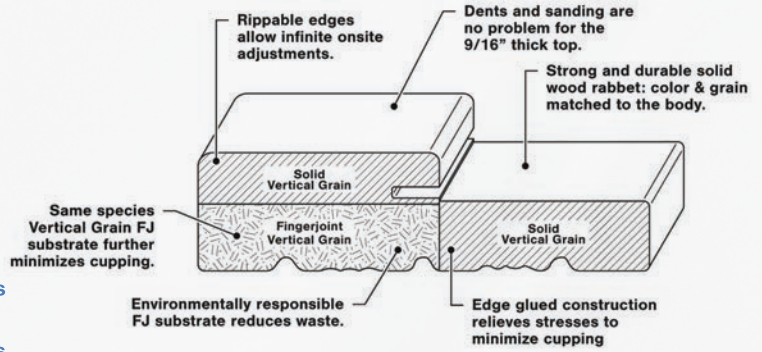

1-3/4" doors only (Engineered in both Flat Grain and Vertical Fir Grain)

VG Fir Exterior Door Frame Specs

- N/S
- 1-1/4" Thick
- 6/8 = 82-1/2" Below Dado
- 8/0 = 98-1/2" Below Dado
- No Screen Rabbet

Flat Grain Fir Exterior

- S
- Single End Dado (Except on Lineal)
- 3 Pair Per Bundle
- Kerfing for Bullnose is Available
- Custom Widths Available
- Ripping Strip up to 1"

ENGINEERED EXTERIOR DOOR FRAMES				
Standard for 1/2" x 1-13/16" Door Rab't.				
SELECT CORRECT PART NUMBER BASED ON SPECIE/LOCATION				
SIZE	SPECIE	6/8 PRS.	8/0 PRS.	LINEAL (SOLID VG FIR)
4-1/8"	Flat Grain Fir VG Fir	418FGE6 418VGE6	418FGE8 418VGE8	418FGL 418VGL
4-1/2"	Flat Grain Fir	412FGE6	412FGE8	412FGL
4-5/8"	VG Fir	458VGE6	458VGE8	458VGL
4-3/4"	Flat Grain Fir	434FGE6	434FGE8	434FGL
5-1/4"	Flat Grain Fir VG Fir	514FGE6 514VGE6	514FGE8 514VGE8	514FGL 514VGL
6-1/8"	Flat Grain Fir	618FGE6	618FGE8	618FGL
6-5/8"	Flat Grain Fir VG Fir	658FGE6 658VGE6	658FGE8 658VGE8	658FGL 658VGL
7-1/4"	Flat Grain Fir VG Fir	714FGE6 714VGE6	714FGE8 714VGE8	714FGL 714VGL

Standard Frame for 1-3/4" Doors

Engineered in both Flat Grain and Vertical Fir Grain. *Lineal is solid (not engineered).

lineal pairs available in 6/8 and 8/0; all 6" through 16"

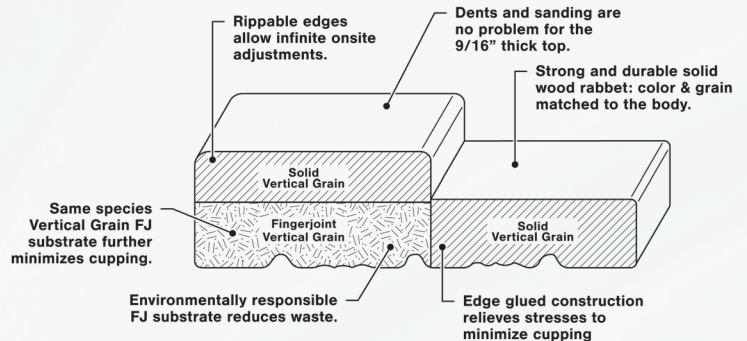

Interior Door Jambs

Engineered Vertical Grain Fir

lineal pairs available in 6/8 and 8/0; all 6" through 16"

INTERIOR DOOR JAMBS			
Engineered VG Doug Fir			
SIZE	6/8 PRS.	8/0 PRS.	RNDM. LINEAL
3-9/16	3916FI6	3916FI8	3916FIL
4-9/16	4916FI6	4916FI8	4916FIL
4-13/16 (4-3/4)	434FI6	434FI8	434FIL
5-1/4	514FI6	514FI8	514FIL
7-1/4	714FI6	714FI8	714FIL
11-1/4	1114FI6	1114FI8	1114FIL



Interior Door Jamb Specs

- 11/16" Thick
- 6/8 = 81" Below Dado
- 8/0 = 97" Below Dado
- Lineal - 5'-16"
- Random Lengths only available in most Solid Wood Species
- Dado depth is 3/8"
- Heads cut 3/4" over opening
- 5 pair per bundle

Kerfing for bullnose is available on all jamb sizes and species. Custom size odd wall widths available upon request.



(items are approximate scale only)

Corner Mold / Quarter Round / Cove

lengths available: 7' through 20'



504R 3/4 x 3/4
Redwood Quarter Round N

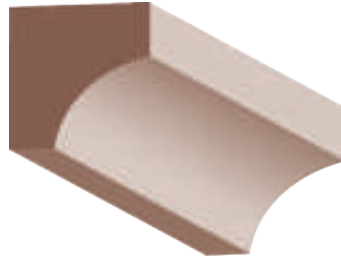

523R 3/4 x 3/4
Redwood Cove N

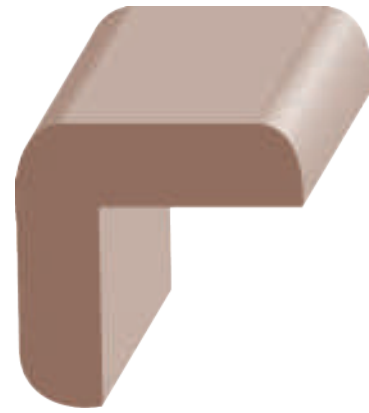

722R 1-1/2 x 1-1/2
Redwood Outside Corner Guard N

S4S / Lattice

lengths available: 7' through 20'



711R 3/4 x 3/4 **Redwood S4S** N



713R 3/8 x 2-1/2 **Redwood S1S2E Batten** N



742R 11/16 x 1-1/2 **Redwood E4E S4S** N



819R	1/4 x 1-3/8	Redwood Lattice	N
820R	1/4 x 1-1/4	Redwood Lattice	S
821R	1/4 x 1-5/8	Redwood Lattice	N/S
822R	1/4 x 2-1/2	Redwood Lattice	S
823R	1/4 x 3-1/2	Redwood Lattice	S
830R	1/4 x 5-1/2	Redwood Lattice	S



Redwood Exterior Molds

lengths available: 6' thru 20' solid redwood | 7' and 17' fj redwood

(items are approximate scale only)



826R 3/4 x 1-1/4
Redwood Stucco Mold **S**



953RFJ 3/4 x 1-1/4
FJ Redwood Stucco Mold **S**



824R 1-3/8 x 1-3/8
Redwood Brick Mold **S**

826AR 7/8 x 1-1/2
Redwood Large Stucco Mold **S**



825R 7/8 x 1-5/8
Redwood Siding Mold **S**



833R 13/16 x 1-1/2
Redwood Stucco Mold **N**



PR842R 15/16 x 1-3/4
Primed Redwood Step Siding Mold **N**

833RFJ 13/16 x 1-1/2
FJ Redwood Stucco Mold **N**

PR833RFJ 13/16 x 1-1/2
FJ Primed Redwood Stucco Mould **N**



PR844RFJ 1 x 2-5/8
Primed FJ Redwood Stucco Mould **N**

Redwood Gutter Mould

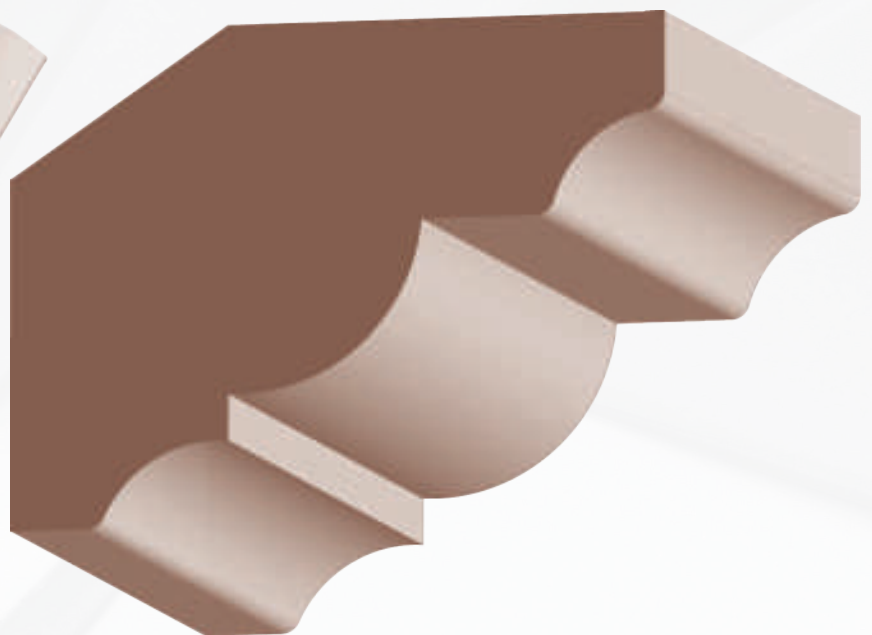

PR760RFJ 1-3/8 x 3-1/4
Primed FJ Redwood Gutter Mould **N**

(items are approximate scale only)

Redwood Shingle Mould



841R 1-1/4 x 1-1/2 **Redwood Brick Mold** **N**
PR841R 1-1/4 x 1-1/2 **Primed Redwood Brick Mold** **N**



739R 11/16 x 1-5/8 **Redwood Shingle Mould** **N**
PR739R 11/16 x 1-5/8 **Primed Redwood Shingle Mould** **N**

Redwood Watertable

 lengths available: 6' thru 16'

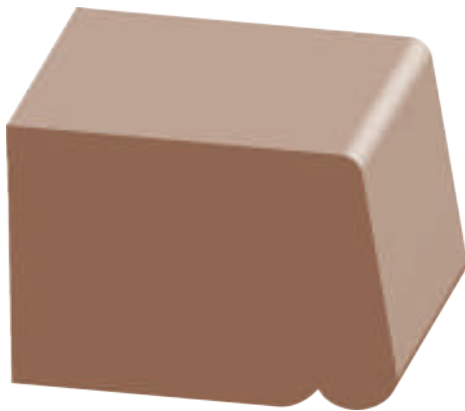

PR827R 1-7/16 x 1-11/16
Primed Redwood Watertable **N**



PR829R 1-7/16 x 3-1/4
Primed Redwood Watertable **N**

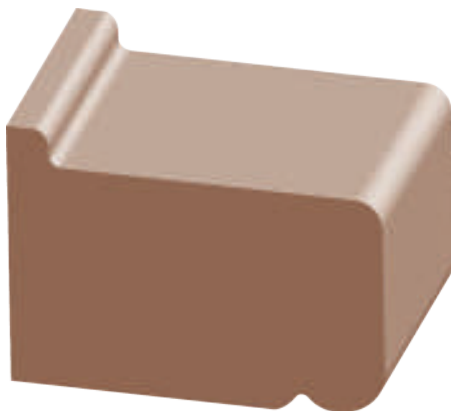

827WR 1-3/8 x 2
Redwood Water Table with Lip **S**

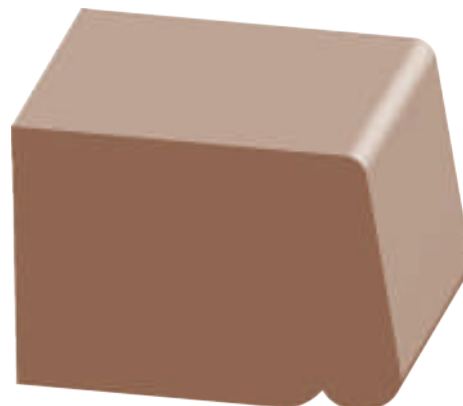

827R 1-7/16 x 2
Redwood Water Table with no Lip **S**

Redwood Window Sill

(items are approximate scale only)



- 8RS** 1-3/8 x 7-1/4 **Redwood Sill** N/S
- 10BRS** 1-3/8 x 8-7/8 **Redwood Sill** N
- 10RS** 1-3/8 x 9-1/4 **Redwood Sill** S



- 8RVS** 1-3/8 x 7-1/4 **Redwood Reversible Sill** N



- 8RSD** 1-3/8 x 7-1/4 **Redwood Sill w/Detail** S

Redwood Wiggle Mould



- 828TP** 3/4 x 1-5/8 **Treated Pine Corrugated Wiggle Mould w/Redwood Stain** N/S
✂ lengths Available: 8'

(items are approximate scale only)

Redwood Handrail

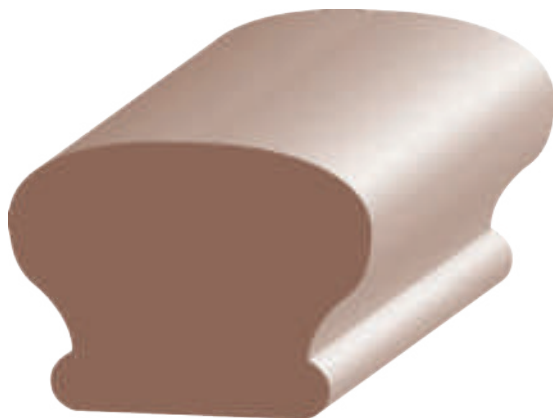

955R 1-7/16 x 1-15/16
Redwood Mushroom Handrail N

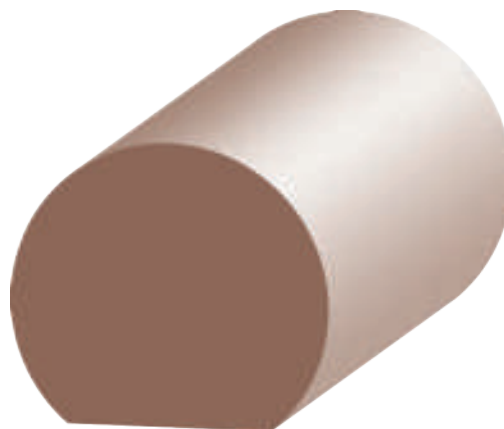

951R 1-1/2 x 1-11/16
Redwood Flat Bottom Handrail N



Big Ideas





American hardwoods are the environmentally friendly choice for today’s modern home design. Our temperate U.S. forests grow nearly twice as much hardwood as we harvest each year. With far more hardwood growth than there is harvesting, American hardwoods, for moulding and millwork, are the definition of environmentally friendly, green and sustainable, now and for future generations. For more information, visit americanhardwood.org.



POPLAR



CHERRY



MAPLE



KNOTTY ALDER



OAK



MAHOGANY



SUPERIOR ALDER



WALNUT



section contents

Astragal.....	322
Base and Base Shoe	288
Casing.....	277
Chair Rail.....	319
Cove	314
Crown.....	299
Dentil Lineal.....	313
Exterior Door Frames.....	332
Exterior Mold	323
Handrail	324
Header	287
Interior Jambs.....	332
Nose & Cove.....	329
Oak Threshold.....	327
Outside Corner Guard.....	323
Panel Mold & Cap	315
Quarter / Half / Full Round.....	314
Reducer	331
Ropes	331
S4S Boards	331
Screen & Pencil Molds	314
Sill	328
Stair Nosing	330
Stool	330
Stop	288
T&G Wainscot.....	321

Hardwoods

DESIGN STYLES

ARTS & CRAFTS | MODERN | ART DECO

**JANKA
HARDNESS**
(POUNDS-FORCE)

950-3000

GREEN CHOICES

American hardwoods are the environmentally friendly choice for today's modern home design. Our temperate U.S. forests grow nearly twice as much hardwood as we harvest each year. This kind of sustainability is meeting today's needs, without compromising the ability of future generations to meet their needs. With far more hardwood growth than there is harvesting, American hardwoods for moulding and millwork are the definition of environmentally friendly, green and sustainable, now and for future generations. For more information, visit www.americanhardwood.org.

CHARACTERISTICS

In stock and available for immediate delivery, our hardwood species include oak, maple, cherry, mahogany, superior or knotty alder and poplar.

All hardwoods, with the exception of poplar, are stain grade and come in 5'-16' lengths – predominantly in 6'-12' lengths. Alder is available up to 10' lengths only.

Poplar :

Little to no grain with light and dark color fluctuations. A green hue is also common. High-end paintgrade product. Can be stained by a highly trained professional.

Oak :

Southern Oak is strong and durable with a beautiful grain that is easy to stain darker or redder. Generally available in 6'-12' lengths. Long lengths are rare.

Cherry & American Cherry :

Spectacular in both color and grain. The sapwood in American Cherry adds a white variation to it's pure red coloring. Cherry that's completely red is considered premium and is not typical of standard stock – it must be specially quoted when "all red" is required.

Mahogany :

Deep rich coloration from pale reddish to dark brown. Flecking is typical.

Maple

Light in color. May be stained or clear coated. Available in hard or soft Maple. Check stock for availability when one or the other is specifically required.

Alder :

Stylish and rustic. Most profiles are Superior Alder grade. Knotty Alder is denoted as: Part Number followed by KA. Standard Superior Alder is denoted as: Part Number followed by ALD. Knotty Alder is available at a reduced cost but is subject to large, sometimes open knots. Longest length available is 10' for both Superior and Knotty Alder.

HELPFUL HINTS

- * **Cope all inside corners** for baseboard, chair rail, and crown molding, unless installing MDF mouldings, and then it's best to miter all inside corners.
- * **Glue all miters and splices**—both sides/pieces of each joint, to control moisture content and to prevent stain from wicking into the endgrain and darkening the miters.
- * **Pre-assemble wide casing using miter clamps.** Without clamping pressure, glue joints will not reach the full strength of the glue.
- * **When mitering wide mouldings**, and for all exterior trim work, use biscuits or dominoes to reinforce miters.
- * **CHECK the moisture content of all wood moulding:** for interior trim, the MC should be 8-10%; for exterior trim the MC should be 12-14%. For every 4% change in MC, wood moves 1%.
- * Exterior trim: use **'splitless' siding nails**—they have blunt tips and prevent wood from splitting.
- * **Pre-drill:** for any nails driven closer than 3/4" to the edge of a board.
- * **For painted trim:** caulk over any nails that are overdriven—countersunk too deep.
- * **Last mouldings to be installed:** base, shoe and quarter rounds.
- * **Chair rails** can be installed 32" to 36" from the floor.
- * Use Rosettes and Plinth blocks at the corners of windows and doors to **eliminate the mitering process.**
- * **After installation is complete:** caulk and/or putty all gaps and nail holes.
- * Use any brand of spray furniture polish on saw blade as a **lubricant for easier cutting.**



MAPLE, PINE, SOME MAHOGANY AND BRAZILIAN CHERRY CAN ABSORB STAIN IN AN INCONSISTENT MANNER CAUSING BLOTCHINESS OR STREAKING. USING A CONDITIONER BEFORE STAINING WILL HELP THE WOOD APPEAR MORE CONSISTENT IN COLOR AND STAIN ABSORPTION.

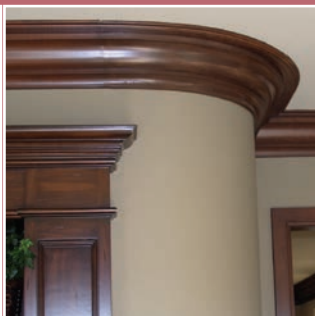

(items are approximate scale only)

1-1/4" to 2-1/4" Casing

lengths available: 6' thru 16'

AS ALL SPECIES
AS* ALL SPECIES EXCEPT KNOTTY ALDER

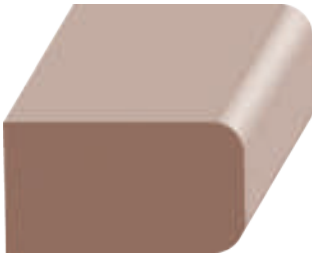

11/16 x 1-1/4 **2 Eased Edge Door Header**
970P Poplar **N**
970ALD Superior Alder **N**

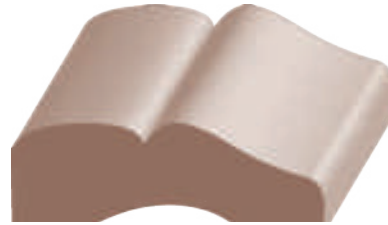

1/2 x 1-9/16 **#711 Casing**
107-0 Oak **S**

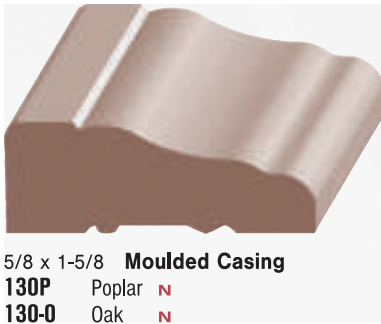

5/8 x 1-5/8 **Moulded Casing**
130P Poplar **N**
130-0 Oak **N**



5/8 x 1-5/8 **Beveled/Streamline Casing**
102-0 Oak **N/S**

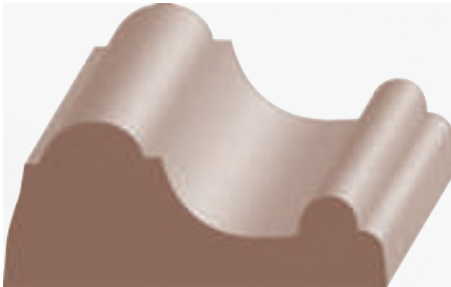

7/8 x 2 **Malibu Casing** **AS***
179P Poplar **S** | **179C** Cherry **S**
179-0 Oak **S** | **179MH** Mahogany **S**
179ALD Superior Alder **S** | **179MP** Maple **S**

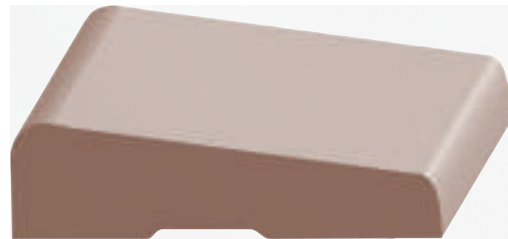

5/8 x 2-1/4 **Beveled Casing**
103-0 Oak **N**



5/8 x 2-1/4 **Moulded Casing**
141P Poplar **N**
141-0 Oak **N**



9/16 x 2-1/4 **Colonial/#356 Casing**
152-0 Oak **N/S**
 11/16 x 2-1/4 **Colonial/#356 Casing** **AS***
152P Poplar **N/S** | **152C** Cherry **N**
152B-0 Oak **N/S** | **152MH** Mahogany **N**
152ALD Superior Alder **N** | **152MP** Maple **N**
152KA Knotty Alder **N**



2-3/8" to 2-1/2" Casing

lengths available: 6' thru 16'

(items are approximate scale only)

AS
ALL SPECIES

AS*
ALL SPECIES
EXCEPT KNOTTY ALDER



5/8 x 2-3/8 **#711 Casing**

108P	Poplar	S
108-0	Oak	S
108ALD	Superior Alder	S
108MH	Mahogany	S



13/16 x 2-7/16 **Santa Fe/#275 Casing**

167P	Poplar	N/S	167C	Cherry	N/S
167-0	Oak	N	167MH	Mahogany	N/S
167ALD	Superior Alder	N	167MP	Maple	N/S

AS*

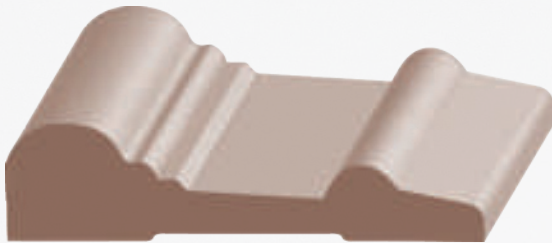

5/8 x 2-7/16 **Universal Casing**

115-0	Oak	S
--------------	-----	----------



13/16 x 2-1/2 **2 Round Edge Casing**

120P	Poplar	N/S	120C	Cherry	N/S
120-0	Oak	N/S	120MH	Mahogany	N/S
120ALD	Superior Alder	N/S	120MP	Maple	N/S
120KA	Knotty Alder	N/S			

AS



11/16 x 2-1/2 **Mission/Bel-Air Casing**

128P	Poplar	N/S	128C	Cherry	N/S
128-0	Oak	N/S	128MH	Mahogany	N/S
128ALD	Superior Alder	N/S	128MP	Maple	N/S
128KA	Knotty Alder	N/S			

AS



5/8 x 2-1/2 **Riviera Casing**

131-0	Oak	N
--------------	-----	----------



11/16 x 2-1/2 **Carolina/Mission Casing**

132P	Poplar	N
132ALD	Superior Alder	N/S

[FORMERLY 182ALD]



11/16 x 2-1/2 **Cape Cod Casing**

150P	Poplar	N/S	150C	Cherry	N/S
150-0	Oak	N/S	150MH	Mahogany	N/S
150ALD	Superior Alder	S	150MP	Maple	N/S



(items are approximate scale only)

2-1/2" Casing

lengths available: 6' thru 16'

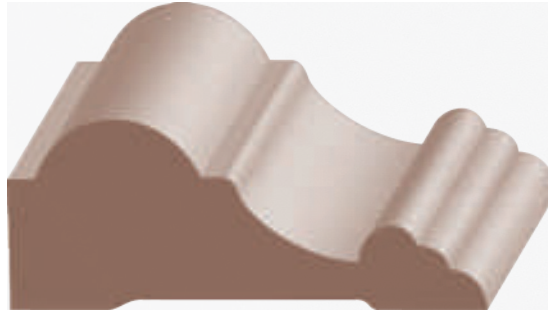

1 x 2-1/2 **Lancaster/Hermosa Casing**
159P Poplar **N/S**



11/16 x 2-1/2 **Crescent Casing**
168P Poplar **S**
168-0 Oak **S**



5/8 x 2-1/2 **Tudor Casing**
169-0 Oak **S**

3/4 x 2-1/2 **Victorian Casing**
169B-0 Oak **N**



13/16 x 2-1/2 **Howe Casing**

178P	Poplar (3/4 x 2-1/2)	N/S	178MH	Mahogany	N
178ALD	Superior Alder	N	178MP	Maple	N
178C	Cherry	N			



2-7/8" to 3-1/4" Casing

lengths available: 6' thru 16'

(items are approximate scale only)



11/16 x 2-7/8 Colonial Casing

- 119P Poplar **S**
- 119O Oak **S**



11/16 x 2-7/8 Victorian/Newport Casing

- | | |
|--|---|
| <ul style="list-style-type: none"> 125P Poplar N/S 125O Oak N/S 125ALD Superior Alder N/S 125KA Knotty Alder S | <ul style="list-style-type: none"> 125C Cherry N/S 125MH Mahogany N/S 125MP Maple N/S |
|--|---|



5/16 x 3-1/4 2 Eased Edge Mullion Casing

- | | |
|--|--|
| <ul style="list-style-type: none"> 114O3 Oak S 114QW0-3 Qtr Sawn White Oak N/S | <ul style="list-style-type: none"> 114MH-3 Mahogany N/S 114WL-3 Walnut N/S |
|--|--|



3/4 x 3-1/4 Mission/Bel-Air Casing

- | | |
|--|---|
| <ul style="list-style-type: none"> 129P Poplar N/S 129O Oak N/S 129ALD Superior Alder N/S 129KA Knotty Alder N/S | <ul style="list-style-type: none"> 129C Cherry N/S 129MH Mahogany N/S 129MP Maple N/S |
|--|---|



11/16 x 3-1/4 Monterey Casing

- 135ALD Superior Alder **N**
- 135KA Knotty Alder **N**



(items are approximate scale only)



3-1/4" Casing

lengths available: 6' thru 16'



13/16 x 3-1/4 2 Round Edge Casing

139P	Poplar	N/S	139C	Cherry	N/S
139-O	Oak	N/S	139MH	Mahogany	N/S
139ALD	Superior Alder	N/S	139MP	Maple	N/S
139KA	Knotty Alder	N/S			



1-1/8 x 3-1/4 Lancaster/Hermosa Casing

160P	Poplar	N/S	160C	Cherry	N/S
160-O	Oak	N/S	160MH	Mahogany	N/S
160ALD	Superior Alder	S	160MP	Maple	N/S
160KA	Knotty Alder	S			



11/16 x 3-1/4 Cambridge Casing

161-O	Oak	S
--------------	-----	---



11/16 x 3-1/4 Colonial Casing

176P	Poplar	N	176C	Cherry	N
176-O	Oak	N	176MH	Mahogany	N
176ALD	Superior Alder	N	176MP	Maple	N
176KA	Knotty Alder	N			



3-1/4" to 3-3/8" Casing

lengths available: 6' thru 16'

(items are approximate scale only)

AS
ALL SPECIES

AS*
ALL SPECIES
EXCEPT KNOTTY ALDER



1 x 3-1/4" **49er Casing** **AS***

186P Poplar	N	186C Cherry	N
186-O Oak	N	186MH Mahogany	N
186ALD Superior Alder	N	186MP Maple	N



3/4 x 3-1/4" **4-Reed Casing**

CA326P Poplar	N/S
CA326-O Oak	S

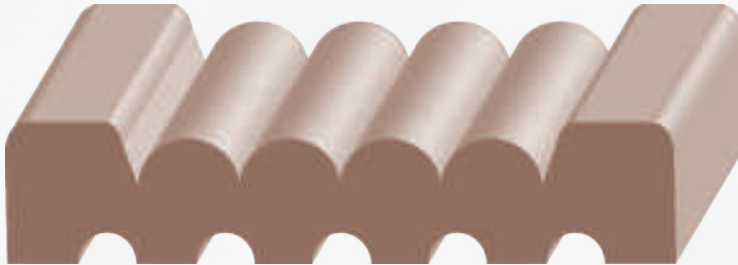

3/4 x 3-1/2" **Reversible 5-Flute & Reed Casing** **AS***

158P Poplar	N/S	158C Cherry	N/S
158-O Oak	N/S	158MH Mahogany	N/S
158ALD Superior Alder	N/S	158MP Maple	N/S



1-3/8 x 3-3/8" **Malibu Casing**

180P Poplar	N/S
--------------------	------------



(items are approximate scale only)

3-1/2" Casing

✂ lengths available: 6' thru 16'



3/4 x 3-1/2 Crescent Casing

- 126P** Poplar S
- 126-O** Oak S



11/16 x 3-1/2 Cape Cod Casing

- 155P** Poplar N/S
- 155-O** Oak S
- 155ALD** Superior Alder S

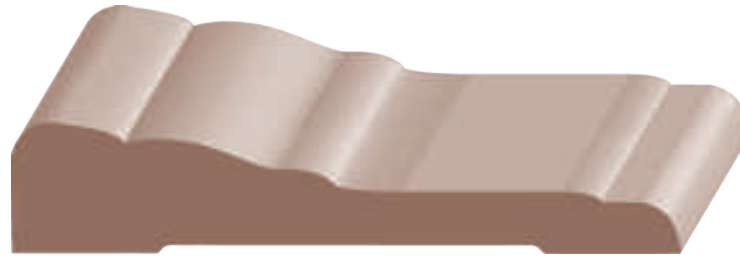

11/16 x 3-1/2 Chesapeake Casing

- 156-O** Oak S



1 x 3-1/2 Santa Fe Casing

- | | |
|---|--|
| 166P Poplar N | 166C Cherry N |
| 166ALD Superior Alder N | 166MH Mahogany N |
| 166KA Knotty Alder N | 166MP Maple N |

1-1/16 x 3-1/2 #275 Casing

- | | |
|--|---|
| 165P Poplar S | 165C Cherry S |
| 165ALD Superior Alder S | 165MH Mahogany S |
| 165KA Knotty Alder S | 165MP Maple S |



3-1/2" to 3-3/4" Casing

(items are approximate scale only)

✦ lengths available: 6' thru 16'



- 1 x 3-1/2 Howe Casing**
- | | | | | | |
|---------------|----------------|-----|--------------|----------|---|
| 177P | Poplar | N/S | 177C | Cherry | N |
| 177ALD | Superior Alder | N | 177MH | Mahogany | N |
| 177KA | Knotty Alder | N | 177MP | Maple | N |



- | | |
|--|------------------------------------|
| 3/4 x 3-1/2 Carolina Casing | 7/8 x 3-1/2 Palisade Casing |
| 133P Poplar N | 185ALD Superior Alder S |
| 133-0 Oak N | |
| 133ALD Superior Alder (7/8 x 3-1/2) N | |

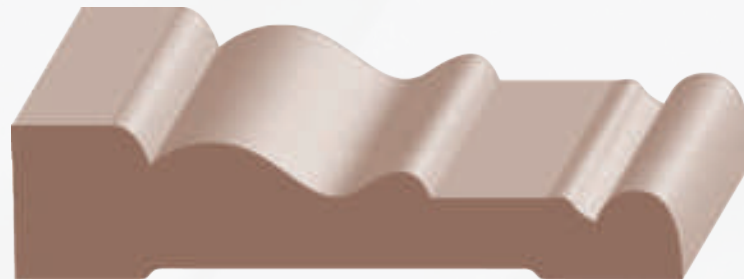

- 13/16 x 3-1/2 Tuscan Casing**
CA364P Poplar S



- 13/16 x 3-3/4 Sierra/Tuscany Casing**
- | | | |
|--------------|----------|-----|
| 175-0 | Oak | N/S |
| 175C | Cherry | S |
| 175MH | Mahogany | S |
| 175MP | Maple | S |

(items are approximate scale only)

4" to 4-1/4" Casing

lengths available: 6' thru 16'



3/4 x 4 **Fancy 4-Flute Casing**
CA327P Poplar **N/S**



3/4 x 4 **2 Eased Edge Craftsman Casing**
199ALD Superior Alder **N/S** [FORMERLY KNOWN AS 186ALD]
199KA Knotty Alder **N/S**



1-1/16 x 4-1/8 **Howe Casing**
174P Poplar **N/S**



13/16 x 4-1/4 **Monterey Casing**
136ALD Superior Alder **N**

4-1/4" to 5" Casing

(items are approximate scale only)

lengths available: 6' thru 16'

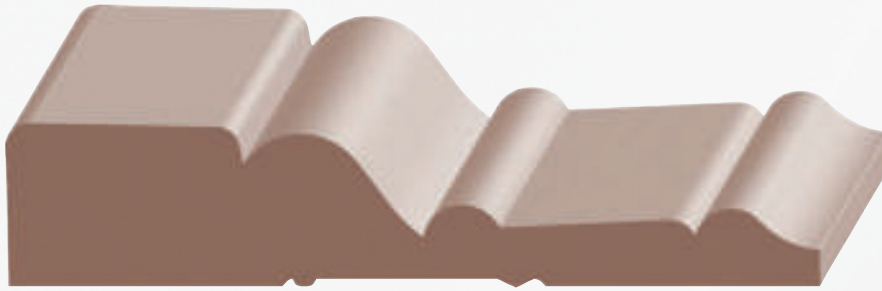

7/8 x 4-1/4 **Tuscany Casing**

140P Poplar **N/S**

140-0 Oak **N**



11/16 x 4-1/4 **Victorian Casing / Chair Rail**

184-0 Oak **S**



1-1/8 x 4-1/2 **Belvedere/Sedona Casing**

190P Poplar **N/S**

190ALD Superior Alder **N**

190KA Knotty Alder **N**

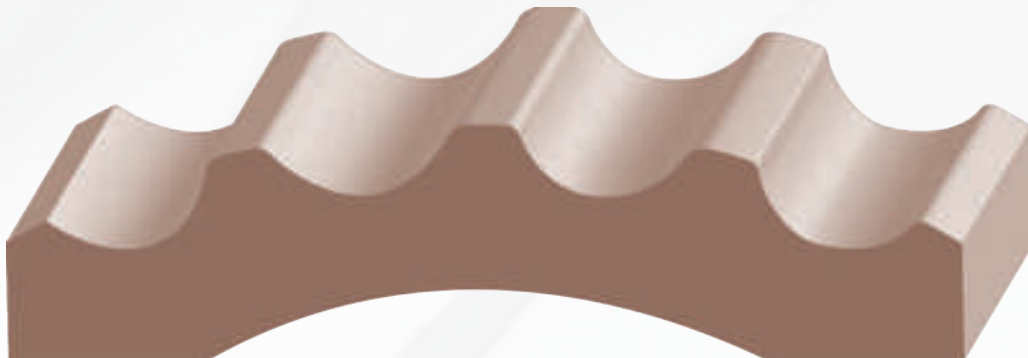

1-1/4 x 5 **Fluted Radial Casing**

191P Poplar **S**

(items are approximate scale only)

5-1/2" Casing

✂ lengths available: 6' thru 16'

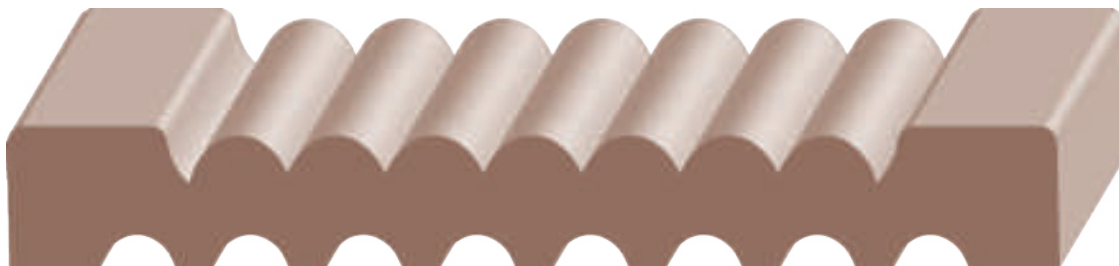

3/4 x 5-1/2 **Reversible 8 Flute & Reed Casing**
171P Poplar **S**



5/16 x 5-1/2 **2 Eased Edge Mullion Casing**
114MH-5 Mahogany **N/S**
114WL-5 Walnut **N/S**
114QW0-5 Qtr Sawn White Oak **N/S**

Header

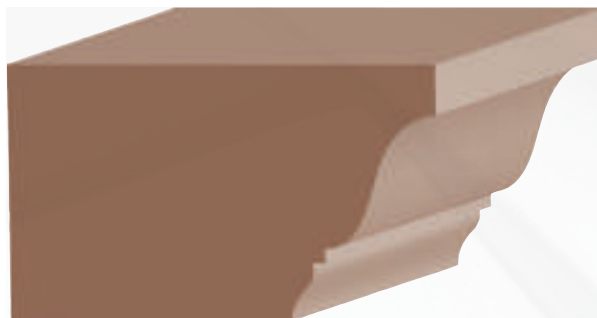

1-3/4 x 2-1/4 **Door Header Cap**
HC150P Poplar **N/S**
HC150-0 Oak **S**
 1-5/16 x 2-1/4 **Door Header Cap**
HC150ALD Superior Alder **N/S**



1-1/16 x 5-1/4 **Door Header**
DH190P Poplar **N/S**
DH190-0 Oak **N/S**



Stop

lengths available: 6' thru 16'

(items are approximate scale only)

AS*
ALL SPECIES
EXCEPT KNOTTY ALDER



7/16 x 1-1/4 1 RE Door Stop
201P Poplar **N** | **201C** Cherry **N**
201-0 Oak **N** | **201MH** Mahogany **N**
201ALD Superior Alder **N** | **201MP** Maple **N**



3/8 x 1-1/4 1 RE Stop
202P Poplar **S**
202-0 Oak **S**



1/2 x 1-1/2 Ogee Stop
219-0 Oak **N**



1/2 x 1-1/2 2 RE Door Stop
209BALD Superior Alder **N**



1/2 x 1-1/2 1 RE Door Stop
209P Poplar **S** | **209C** Cherry **S**
209-0 Oak **S** | **209MH** Mahogany **S**
209ALD Superior Alder **N/S** | **209MP** Maple **S**



1/2 x 1-3/4 Colonial/Ogee Stop
210P Poplar **N/S** | **210C** Cherry **N**
210-0 Oak **S** | **210MH** Mahogany **N**
210ALD Superior Alder **N/S** | **210MP** Maple **N**

Base, Base Shoe & Stop

lengths available: 5' thru 16'



3/8 x 3/4 Base Shoe
300A-0 Oak **S**



1/2 x 3/4 Base Shoe
300BP Poplar **N/S** | **300BC** Cherry **N/S**
300B-0 Oak **N/S** | **300BMH** Mahogany **N/S**
300BALD Superior Alder **N/S** | **300BMP** Maple **N/S**



3/8 x 2-1/4 Reversible Base
R304-02 Oak **N**



3/8 x 2-1/2 Streamline Base
306-0 Oak **S**



3/8 x 2-1/2 #711 Base
310-0 Oak **S**

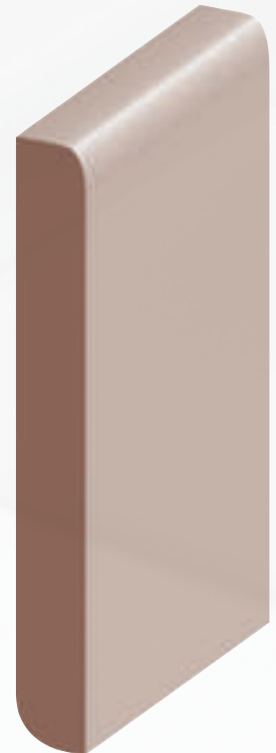

3/8 x 3-1/4 Reversible Base
R304-03 Oak **N**

(items are approximate scale only)

3-1/4" to 3-1/2" Base

lengths available: 6' thru 16'

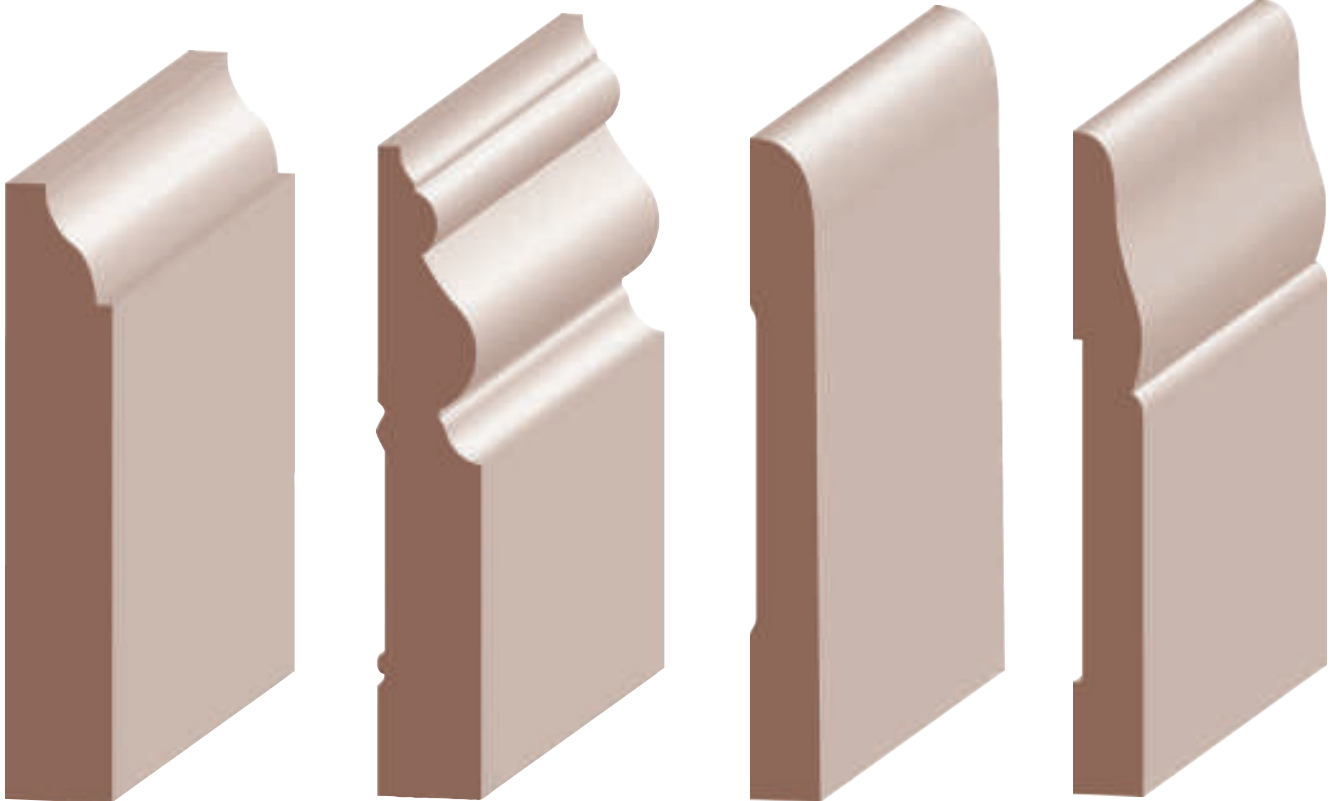

9/16 x 3-1/4 **Coronado/#623 Base**

- 314P-3** Poplar N
- 314O3** Oak N/S
- 314ALD-3** Superior Alder N/S
- 314KA-3** Knotty Alder N
- 314C-3** Cherry N
- 314MH-3** Mahogany N/S
- 314MP-3** Maple N/S

9/16 x 3-3/4 **Santa Fe/#175 Base**

- 338P-3** Poplar N/S [FORMERLY 362P]
- 338O3** Oak N

3/8 x 3-1/2 **Streamline Base**

- 307-0** Oak S

3/8 x 3-1/2 **#711 Base**

- 311P-3** Poplar S
- 311-0** Oak S
- 311ALD-3** Superior Alder S
- 311MH-3** Mahogany S



3-7/8" to 4-1/4" Base

lengths available: 6" thru 16"

(items are approximate scale only)

AS
ALL SPECIES

AS*
ALL SPECIES
EXCEPT KNOTTY ALDER



AS

9/16 x 3-7/8 **Victorian/Newport Base**

329P	Poplar	N/S
329-O	Oak	N/S
329ALD	Superior Alder	N/S
329KA	Knotty Alder	S
329C	Cherry	N/S
329MH	Mahogany	N/S
329MP	Maple	N/S



AS*

9/16 x 3-3/4 **Mission/Hermosa Base**

324P	Poplar	N/S
324-O	Oak	N/S
324ALD	Superior Alder	N/S
324C	Cherry	N/S
324MH	Mahogany	N/S
324MP	Maple	N/S



AS*

9/16 x 4 **Cape Cod Base**

318P-4	Poplar	N/S
318-O4	Oak	N/S
318ALD-4	Superior Alder	S
318C-4	Cherry	N/S
318MH-4	Mahogany	N/S
318MP-4	Maple	N/S

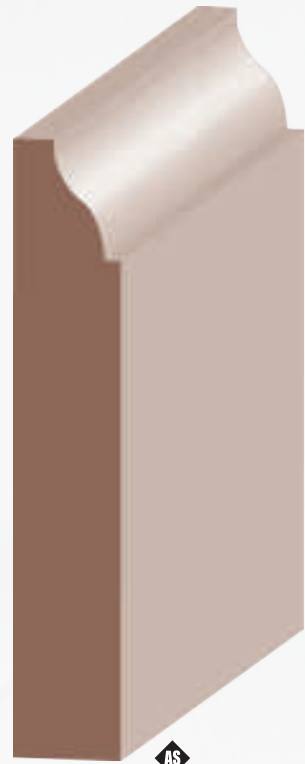

AS

9/16 x 4-1/4 **Coronado/#623 Base**

314P-4	Poplar	N/S
314-O4	Oak	N/S
314ALD-4	Superior Alder	N/S
314KA-4	Knotty Alder	N
314C-4	Cherry	N/S
314MH-4	Mahogany	N/S
314MP-4	Maple	N/S



(items are approximate scale only)

4-3/16" to 4-1/4" Base

lengths available: 6' thru 16'



7/16 x 4-3/16 **#711 Base**
311P-4 Poplar **S**



1/2 x 4-1/4 **Colonial Base**
118P-4 Poplar **S**
118-04 Oak **S**



7/16 x 4-1/4 **Monterey Base**
316-0 Oak **S**



9/16 x 4-1/4 **Crescent Base**
326P Poplar **S**
326-0 Oak **S**

4-1/4" to 4-3/8" Base

lengths available: 6' thru 16'

(items are approximate scale only)

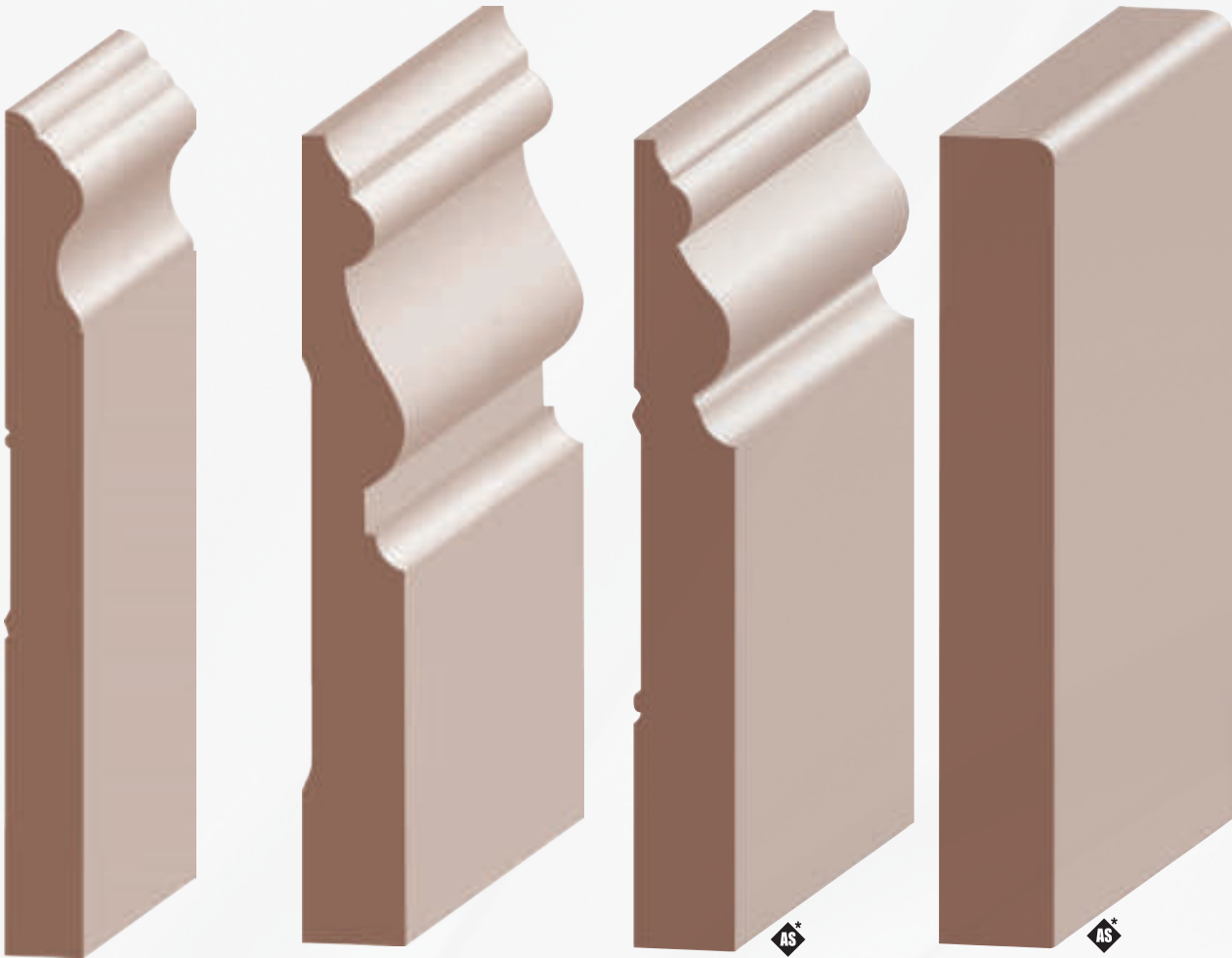

5/8 x 4-1/4 **Mission Bay Base**

333P-4 Poplar **S**
 [FORMERLY 361PM]

9/16 x 4-3/8 **Imperial/#175 Base**

325P Poplar **S**
325ALD Superior Alder **S**
325C Cherry **S**
325MH Mahogany **S**
325MP Maple **S**

9/16 x 4-3/8 **Santa Fe Base**

338P-4 Poplar **N**
338-04 Oak **N**
338ALD-4 Superior Alder **N**
338C-4 Cherry **N**
338MH-4 Mahogany **N**
338MP-4 Maple **N**

5/8 x 4-3/8 **1 Eased Edge Craftsman Base**

387P-4 Poplar **N/S**
387-04 Oak **N/S**
387ALD-4 Superior Alder **N/S**
387C-4 Cherry **N/S**
387MH-4 Mahogany **N/S**
387MP-4 Maple **N/S**
 [FORMERLY 348P]

(items are approximate scale only)

5" to 5-1/4" Base

lengths available: 6' thru 16'

AS
ALL SPECIES

AS*
ALL SPECIES
EXCEPT KNOTTY ALDER



5/8 x 5 **Mission/Hermosa Base**

323P	Poplar	N/S
323-O	Oak	N/S
323C	Cherry	N/S
323MH	Mahogany	N/S
323MP	Maple	N/S



9/16 x 5-1/4 **Coronado/#618 Base**

314P-5	Poplar	N/S
314-O5	Oak	N/S
314ALD-5	Superior Alder	N/S
314KA-5	Knotty Alder	N
314C-5	Cherry	N/S
314MH-5	Mahogany	N/S
314MP-5	Maple	N/S



9/16 x 5-1/4 **Cape Cod Base**

318P-5	Poplar	N/S
318-O5	Oak	S
318ALD-5	Superior Alder	S
318C-5	Cherry	N/S
318MH-5	Mahogany	N/S
318MP-5	Maple	N/S



9/16 x 5-1/4 **Victorian Base**

330BP	Poplar	N
330B-O	Oak	N
330BALD	Superior Alder	N
330BC	Cherry	N
330BMH	Mahogany	N
330BMP	Maple	N

9/16 x 5 **Newport Base**

330P	Poplar	S
330-O	Oak	S
330ALD	Superior Alder	S
330KA	Knotty Alder	S
330C	Cherry	S
330MH	Mahogany	S
330MP	Maple	S



5-1/4" Base

lengths available: 6" thru 16"

(items are approximate scale only)

AS*
ALL SPECIES
EXCEPT KNOTTY ALDER



9/16 x 5-1/4 **Colonial Base**
118P-5 Poplar **S**



9/16 x 5-1/4 **Vintage/Colonial Base**
328P-5 Poplar **S**
328ALD-5 Superior Alder **N/S**
328KA-5 Knotty Alder **N**



9/16 x 5-1/4 **Classic Beaded Base**
359P Poplar **N**



AS*
5/8 x 5-1/4 **Monterey Base**
361P-5 Poplar **N**
361-05 Oak **N**
361ALD-5 Superior Alder **N**
361KA-5 Knotty Alder **N**
361C-5 Cherry **N**
361MH-5 Mahogany **N**
361MP-5 Maple **N**



(items are approximate scale only)

AS
ALL SPECIES

5-1/4" to 5-7/16" Base

lengths available: 6' thru 16'



3/4 x 5-1/4 **Crescent Base**
365P-5 Poplar **N**



9/16 x 5-3/8 **Santa Fe/#175 Base**
338P-5 Poplar **N/S**
338O-5 Oak **N**
338ALD-5 Superior Alder **N**
338KA-5 Knotty Alder **N**
338C-5 Cherry **N/S**
338MH-5 Mahogany **N/S**
338MP-5 Maple **N/S**

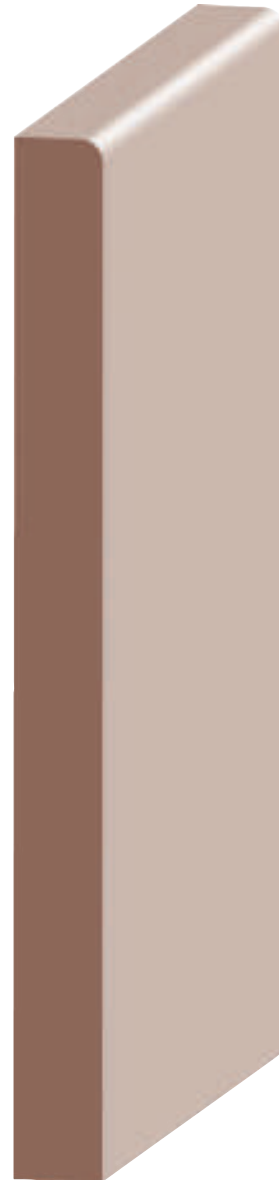

5/8 x 5-7/16 **1 Eased Edge Craftsman Base**
387KA-5 Knotty Alder **N**



5-3/4" to 6" Base

lengths available: 6" thru 16"

(items are approximate scale only)



11/16 x 5-3/4
332P Poplar *N/S*
**Santa Clara/
 Crescent Base**



5/8 x 6
360P Poplar *S*
Cape Cod Base



11/16 x 6
375P-6 Poplar *N/S*
375-06 Oak *N/S*
375C-6 Cherry *S*
375MH-6 Mahogany *S*
375MP-6 Maple *S*
Tuscany Base

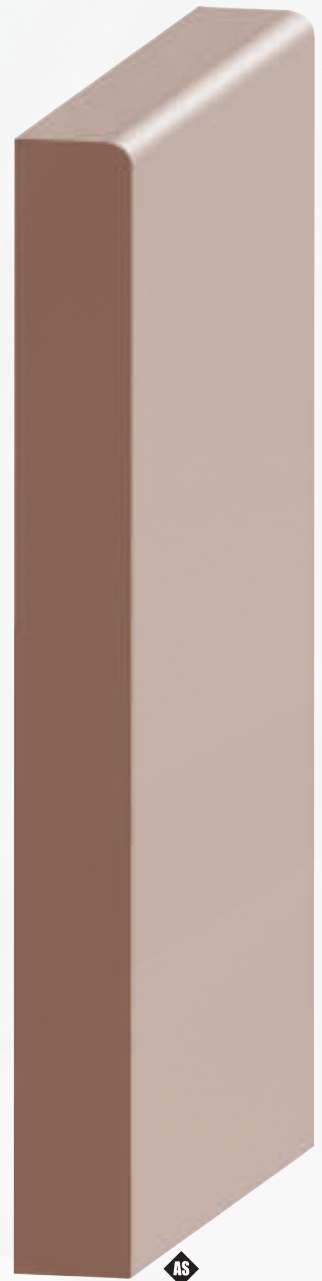

5/8 x 6
387P-6 Poplar *N/S*
387-06 Oak *N/S*
387ALD-6 Superior Alder *N/S*
387KA-6 Knotty Alder *S*
387C-6 Cherry *N/S*
387MH-6 Mahogany *N/S*
387MP-6 Maple *N/S*
1 Eased Edge Craftsman Base



(items are approximate scale only)

AS*
ALL SPECIES
EXCEPT KNOTTY ALDER

6" to 7-1/4" Base

lengths available: 6" thru 16"

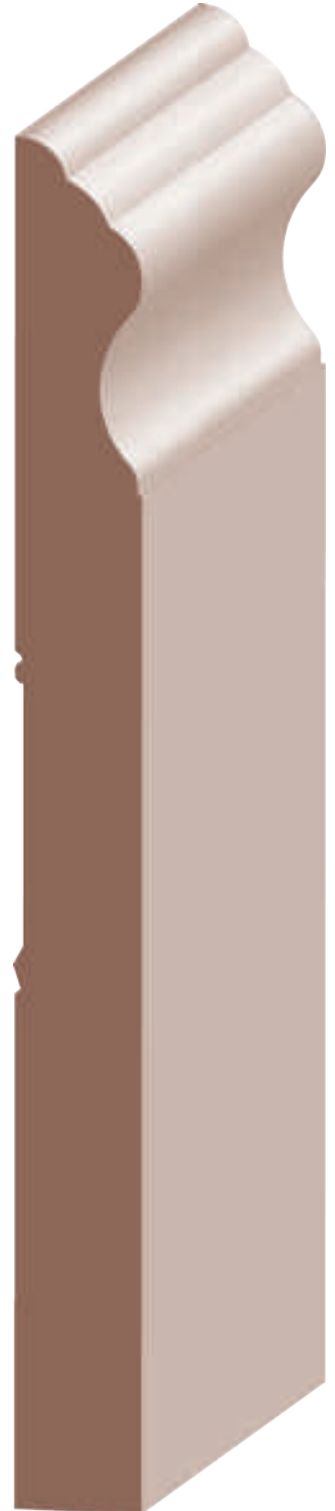

5/8 x 6 **Carolina/Palisade Base**
385P Poplar **N**
385-O Oak **N**
385ALD Superior Alder **N/S**
385C Cherry **N**
385MH Mahogany **N**
385MP Maple **N**

5/8 x 6-1/4 **Imperial/#175 Base**
342P-6 Poplar **N/S**
342ALD-6 Superior Alder (5/8 x 6) **N/S**
342KA-6 Knotty Alder (5/8 x 6) **N/S**
342C-6 Cherry **S**
342MH-6 Mahogany **S**
342MP-6 Maple **S**

11/16 x 7-1/4 **Tuscany Base**
375P-7 Poplar **S**

11/16 x 7-1/4 **Mission Bay Base**
333P-7 Poplar **S**



7-3/16" to 7-1/4" Base

lengths available: 6" thru 16"

(items are approximate scale only)



ALL SPECIES
EXCEPT KNOTTY ALDER

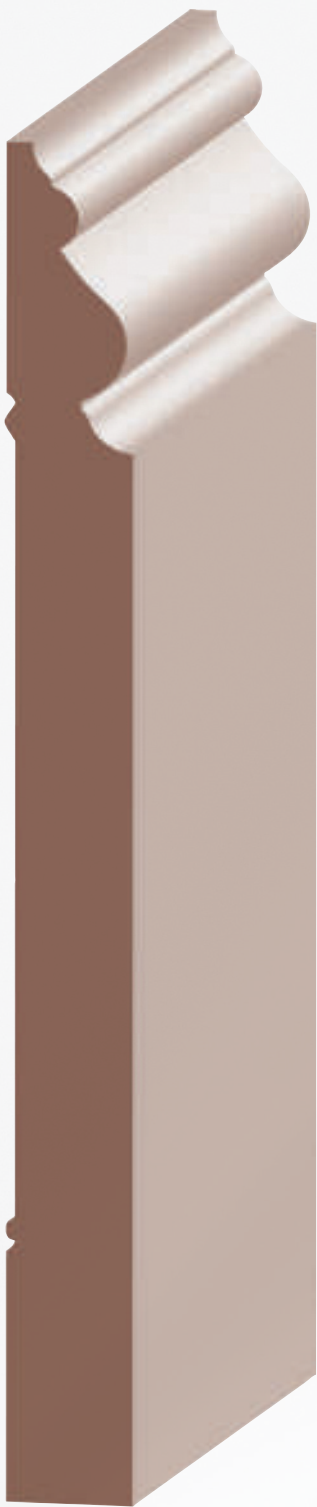

11/16 x 7-3/16 **Santa Fe/#175 Base**
338P-7 Poplar *N/S*

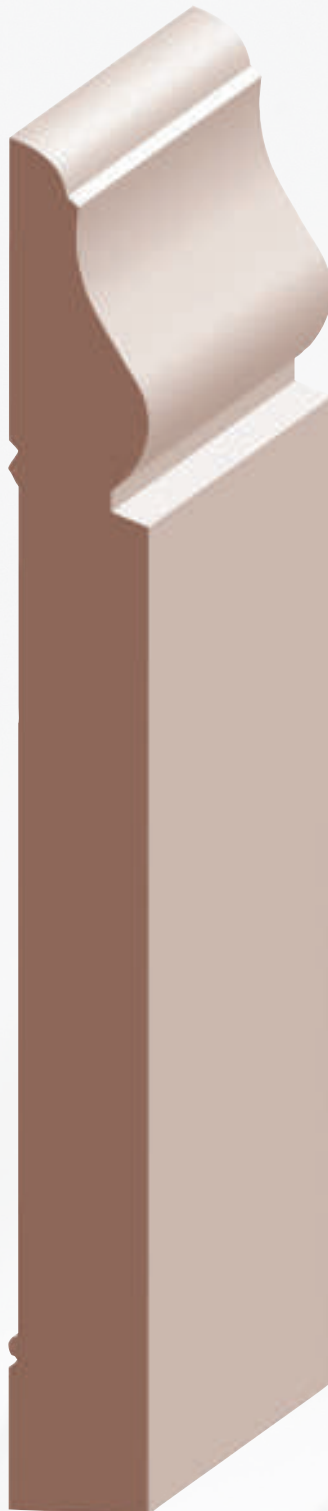

3/4 x 7-1/4 **Crescent Base**
365P-7 Poplar **N**



11/16 x 7-1/4 **Malibu/Hermosa Base**
340P Poplar *N/S*
340ALD Superior Alder *N/S*



9/16 x 7-1/4 **Monterey Base**
361P-7 Poplar *N/S*
361-07 Oak **N**
361ALD-7 Superior Alder *N/S*
361C-7 Cherry *N/S*
361MH-7 Mahogany *N/S*
361MP-7 Maple *N/S*



(items are approximate scale only)

1-5/8" to 3-1/4" Crown

lengths available: 6' thru 16'

AS*
ALL SPECIES
EXCEPT KNOTTY ALDER

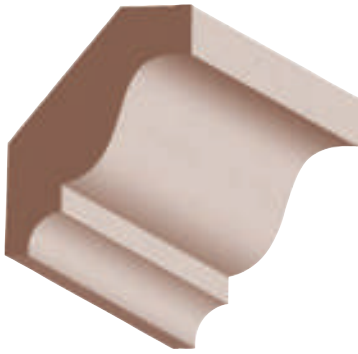

1/2 x 1-5/8 **Colonial Crown**
400-0 Oak **N**

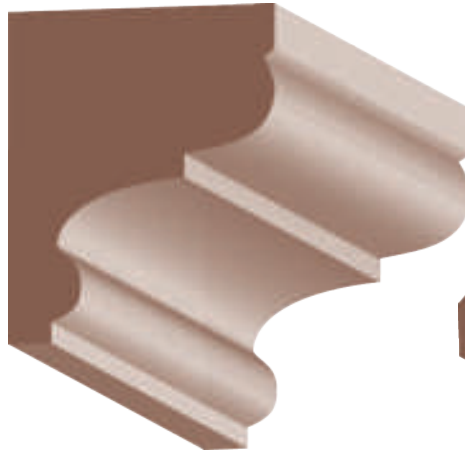

1-7/16 x 1-3/4 **Bed/Cabinet Crown**
452P Poplar **S**
[FORMERLY 403P]

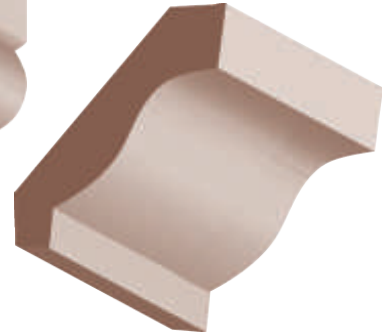

1/2 x 1-5/8 **Crown**
401-01 Oak **S**

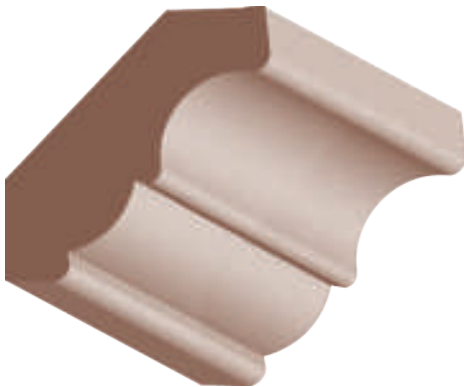

9/16 x 1-7/8 **Bed Mold Crown**
420ALD Superior Alder **S**

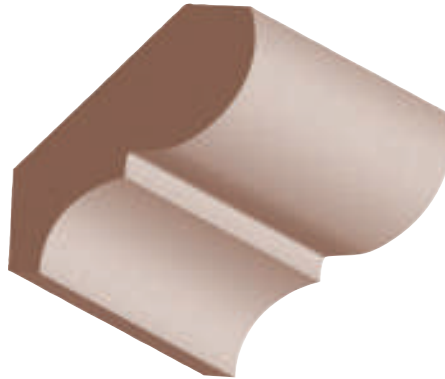

9/16 x 1-7/8 **Bed Mold Crown**
437ALD Superior Alder **N**

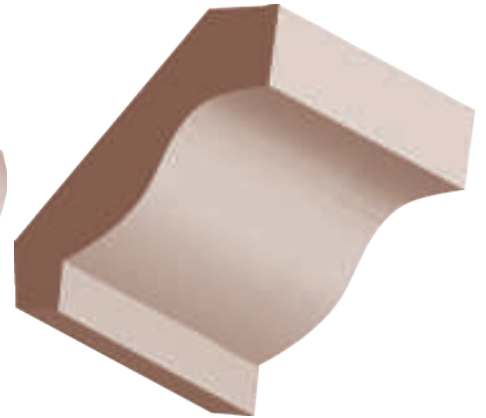

1/2 x 2-1/4 **Crown**
401-02 Oak **S**

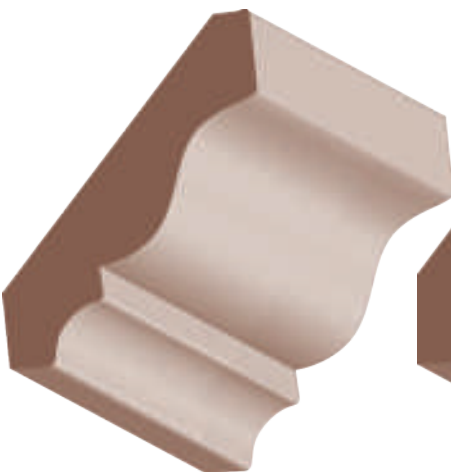

1/2 x 2-1/4 **Colonial Crown**
404-0 Oak **S**

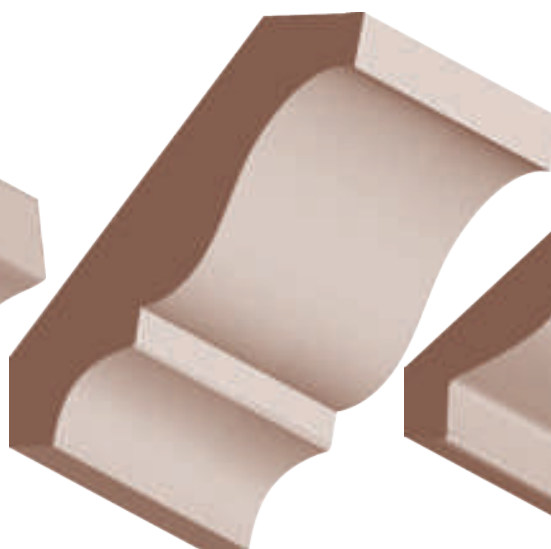

1/2 x 2-3/4 **Colonial Crown** **AS***
436P Poplar **N/S**
436-0 Oak **N/S**
436ALD Superior Alder **N/S**
436C Cherry **N/S**
436MH Mahogany **N/S**
436MP Maple **N/S**

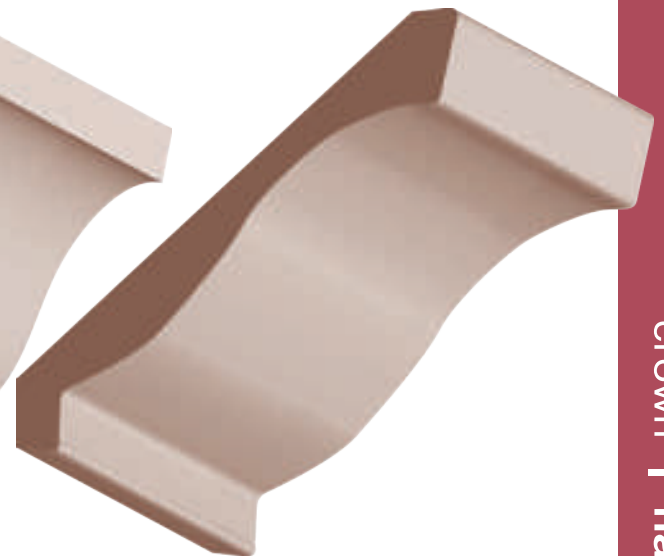

1/2 x 3-1/4 **Crown**
401-03 Oak **S**
[FORMERLY 402-O]



3-1/4" to 3-7/16" Crown

(items are approximate scale only)

lengths available: 6" thru 16"

AS
ALL SPECIES

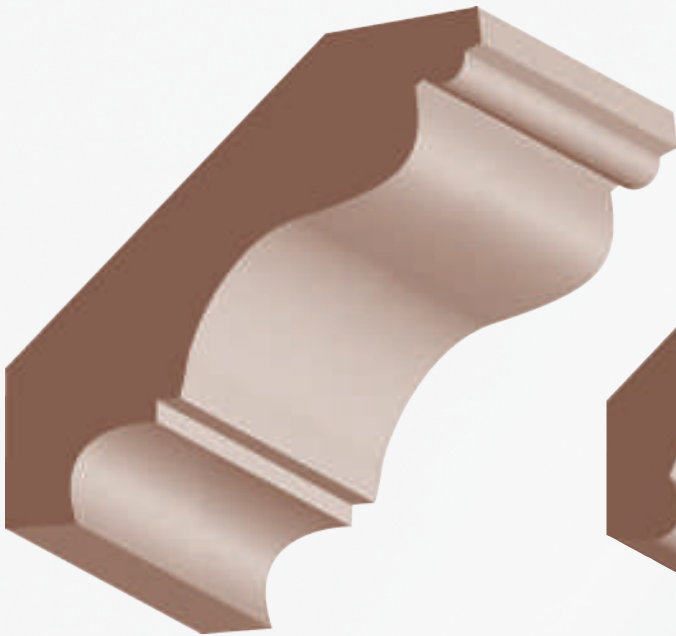

1/2 x 3-1/4 **Beaded Colonial Crown**
405BP Poplar **S**
405B-0 Oak **S**

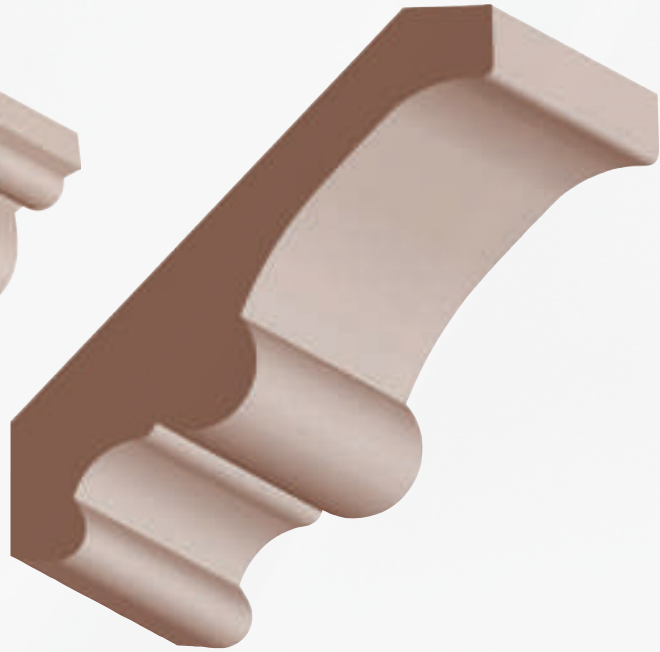

11/16 x 3-1/4 **Single Beaded Crown**
441P Poplar **N**

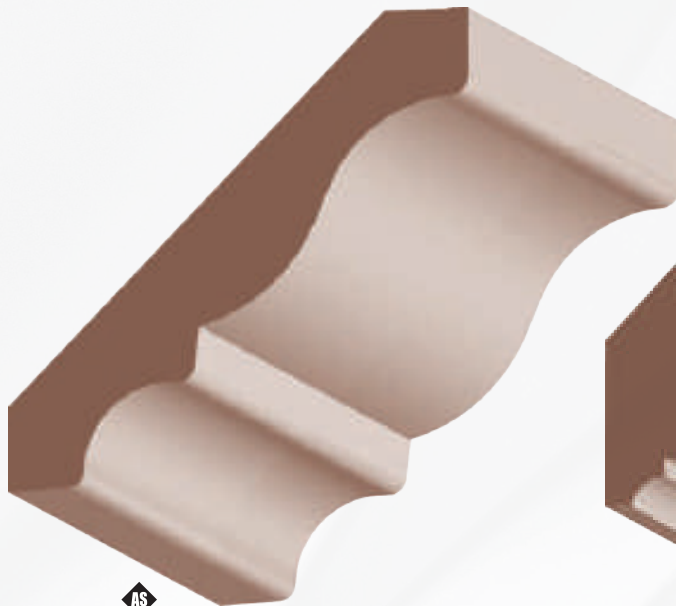

AS
 1/2 x 3-1/4 **Colonial Crown**
405P Poplar **N/S**
405-0 Oak **N/S**
405ALD Superior Alder **N/S**
405KA Knotty Alder **S**
405C Cherry **N/S**
405MH Mahogany **N/S**
405MP Maple **N/S**

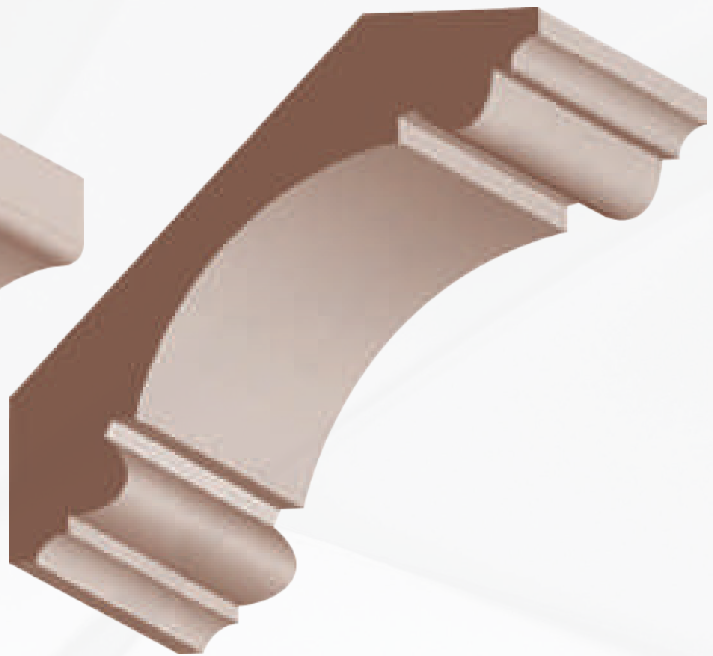

3/4 x 3-7/16 **Double Bead Carolina Crown**
421P Poplar **N**



(items are approximate scale only)

3-1/2" to 4-1/2" Crown

lengths available: 6" thru 16"

AS
ALL SPECIES

AS*
ALL SPECIES
EXCEPT KNOTTY ALDER

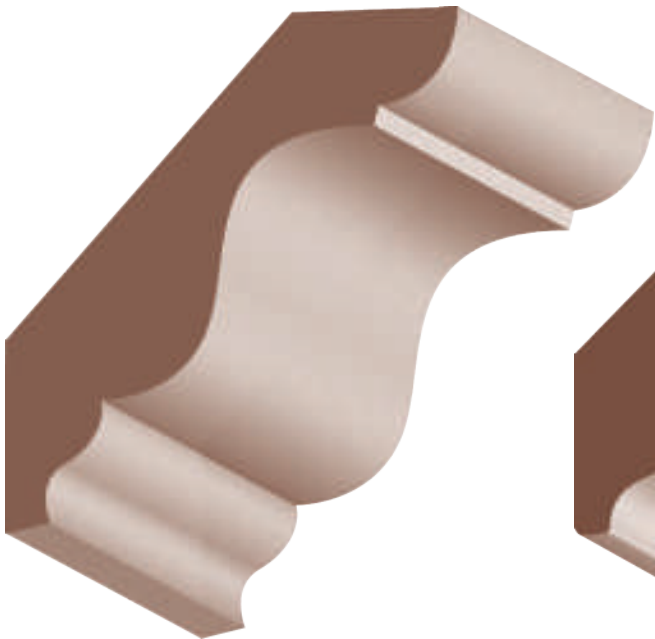

11/16 x 3-1/2 **Bed Mold**
CR820P Poplar *N/S*

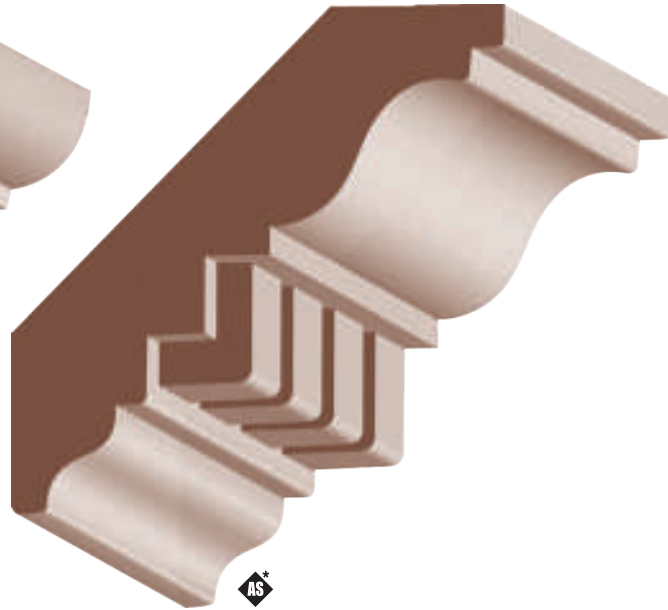

13/16 x 3-3/4 **Dentil Crown**

CM74P	Poplar	<i>N/S</i>	CM74C	Cherry	<i>N/S</i>
CM74-O	Oak	<i>N/S</i>	CM74MH	Mahogany	<i>N/S</i>
CM74ALD	Superior Alder	<i>N/S</i>	CM74MP	Maple	<i>N/S</i>

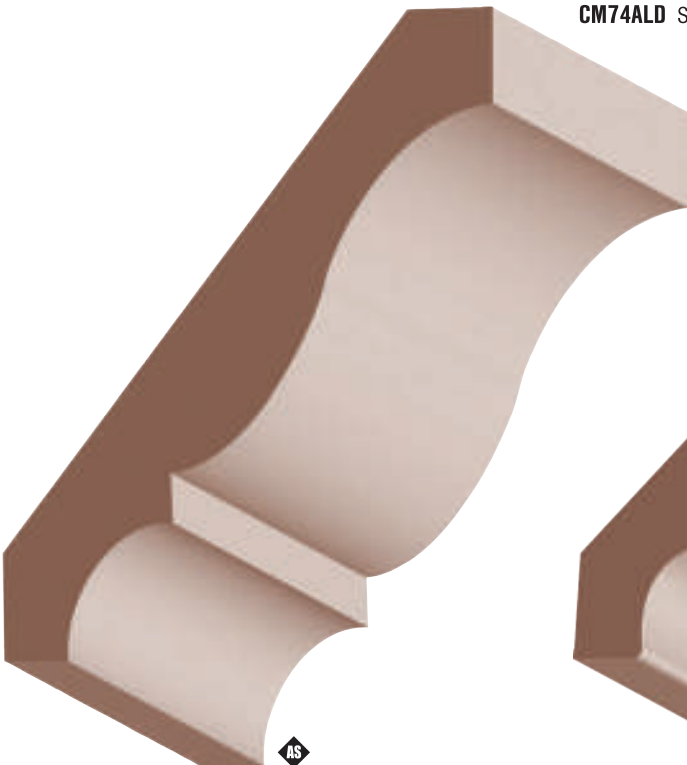

3/4 x 4-1/2 **Colonial Crown**

406P	Poplar	<i>N/S</i>
406-O	Oak	<i>N/S</i>
406ALD	Superior Alder	<i>N/S</i>
406KA	Knotty Alder	<i>N/S</i>
406C	Cherry	<i>N/S</i>
406MH	Mahogany	<i>N/S</i>
406MP	Maple	<i>N/S</i>

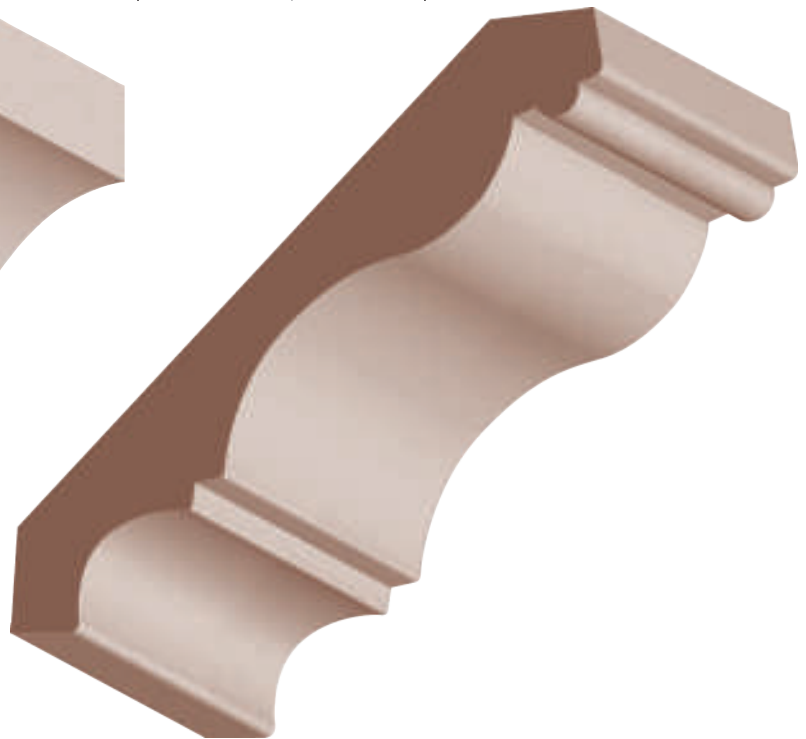

5/8 x 4-1/2 **Beaded Colonial Crown**

406BP	Poplar	<i>S</i>
406B-O	Oak	<i>S</i>
406BC	Cherry	<i>S</i>
406BMH	Mahogany	<i>S</i>
406BMP	Maple	<i>S</i>



4-1/2" to 4-5/8" Crown

(items are approximate scale only)

lengths available: 6" thru 16"

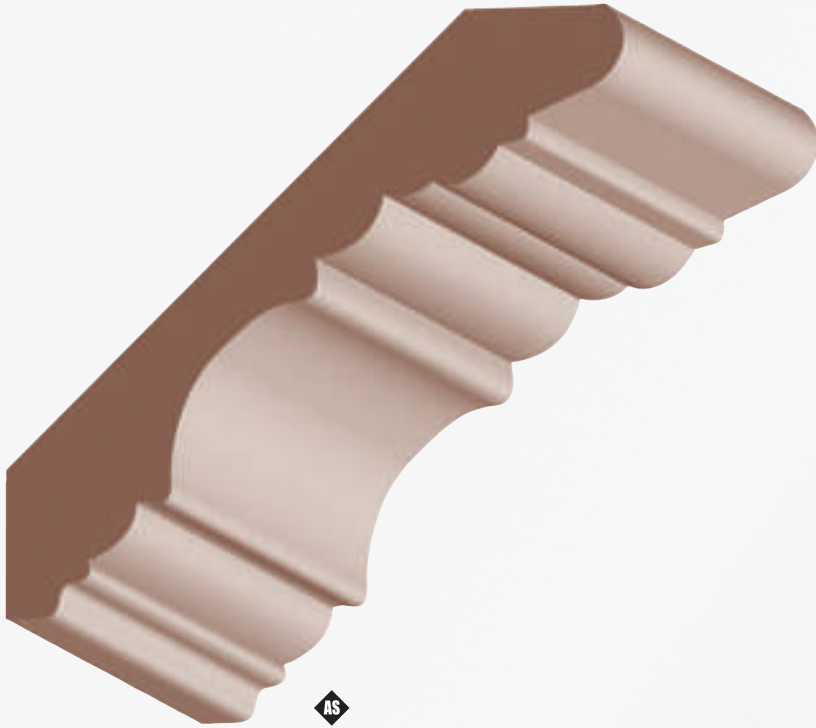

3/4 x 4-1/2 **Coronado/Georgian Crown**

412P	Poplar	N/S
412-O	Oak	N/S
412ALD	Superior Alder	N/S
412KA	Knotty Alder	S
412C	Cherry	N/S
412MH	Mahogany	N/S
412MP	Maple	N/S

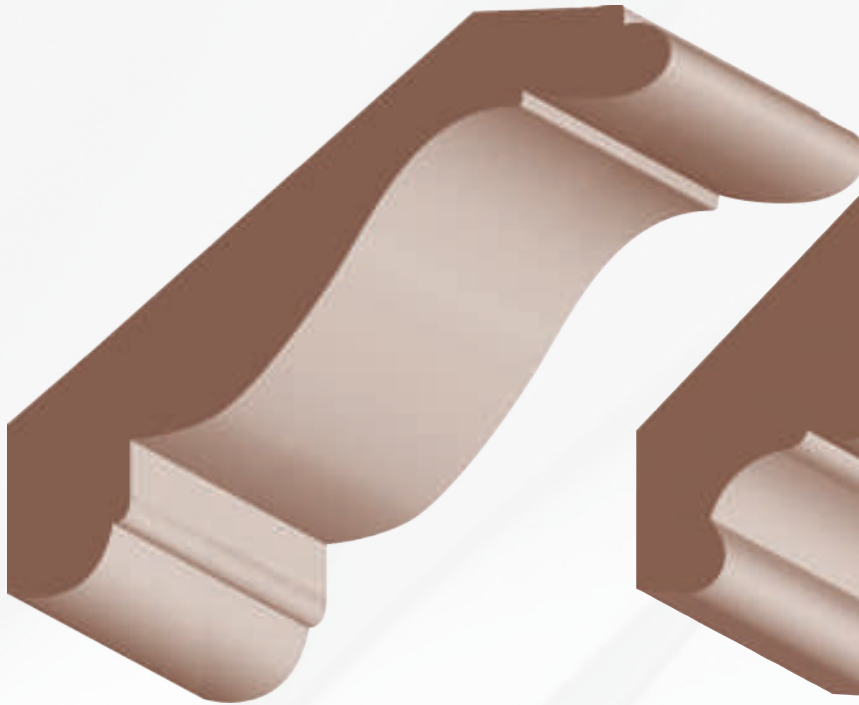

13/16 x 4-1/2 **Rancho Crown**
409-O Oak S

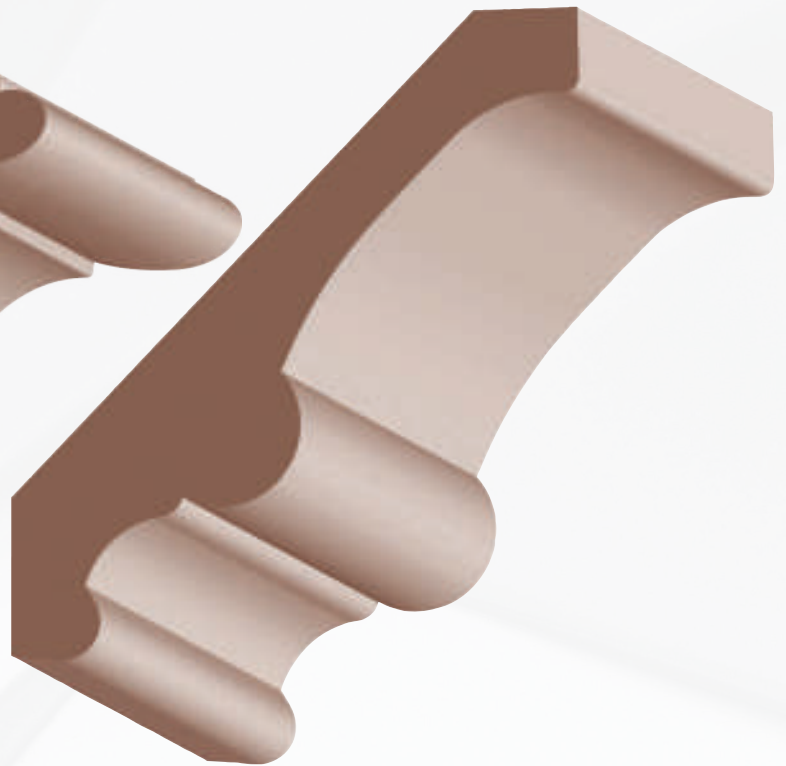

13/16 x 4-5/8 **Single Beaded Crown**
442P Poplar N



(items are approximate scale only)

4-5/8" to 5-1/4" Crown

lengths available: 6" thru 16"

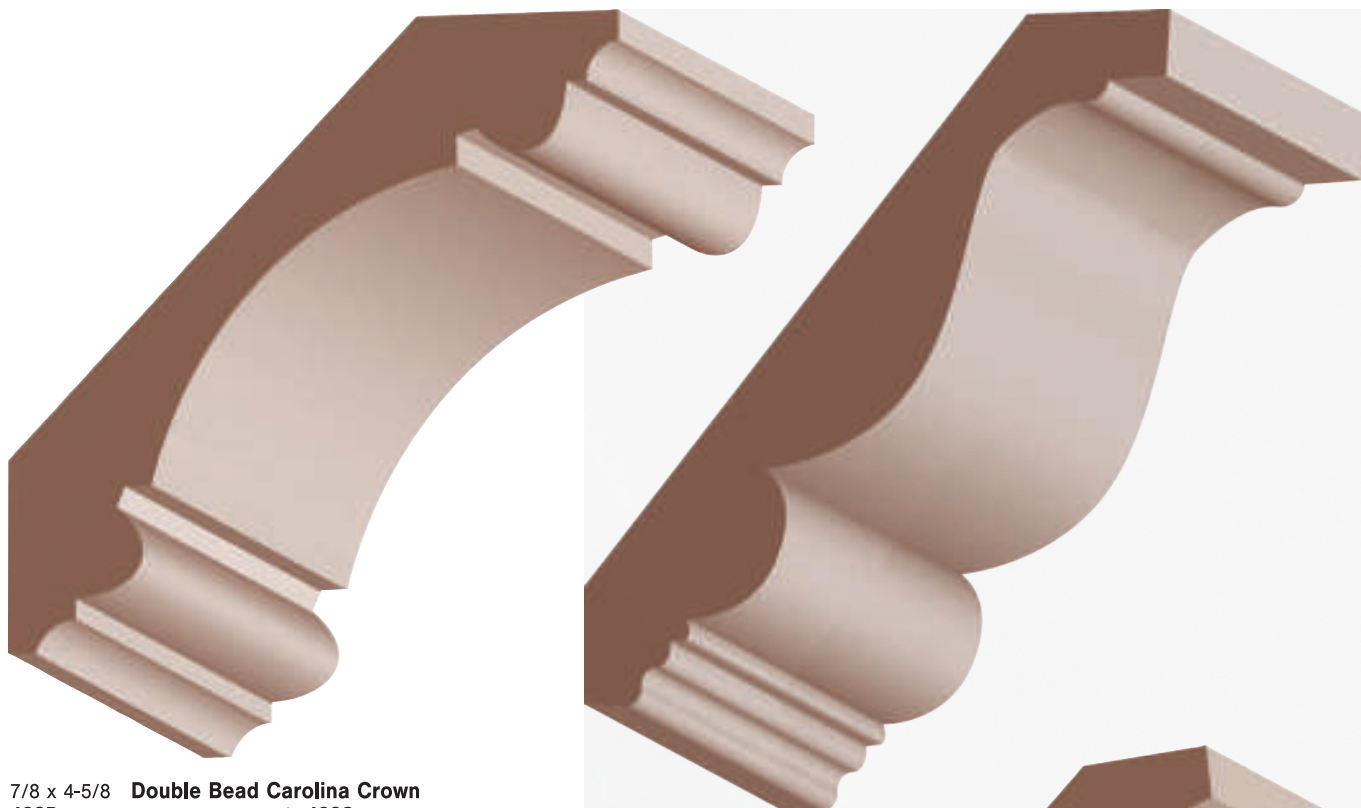

7/8 x 4-5/8 **Double Bead Carolina Crown**

423P	Poplar	N/S	423C	Cherry	N
423ALD	Superior Alder	N/S	423MH	Mahogany	N
423KA	Knotty Alder	N	423MP	Maple	N

11/16 x 4-3/4 **Imperial Crown**

CR810P	Poplar	N/S
---------------	--------	-----

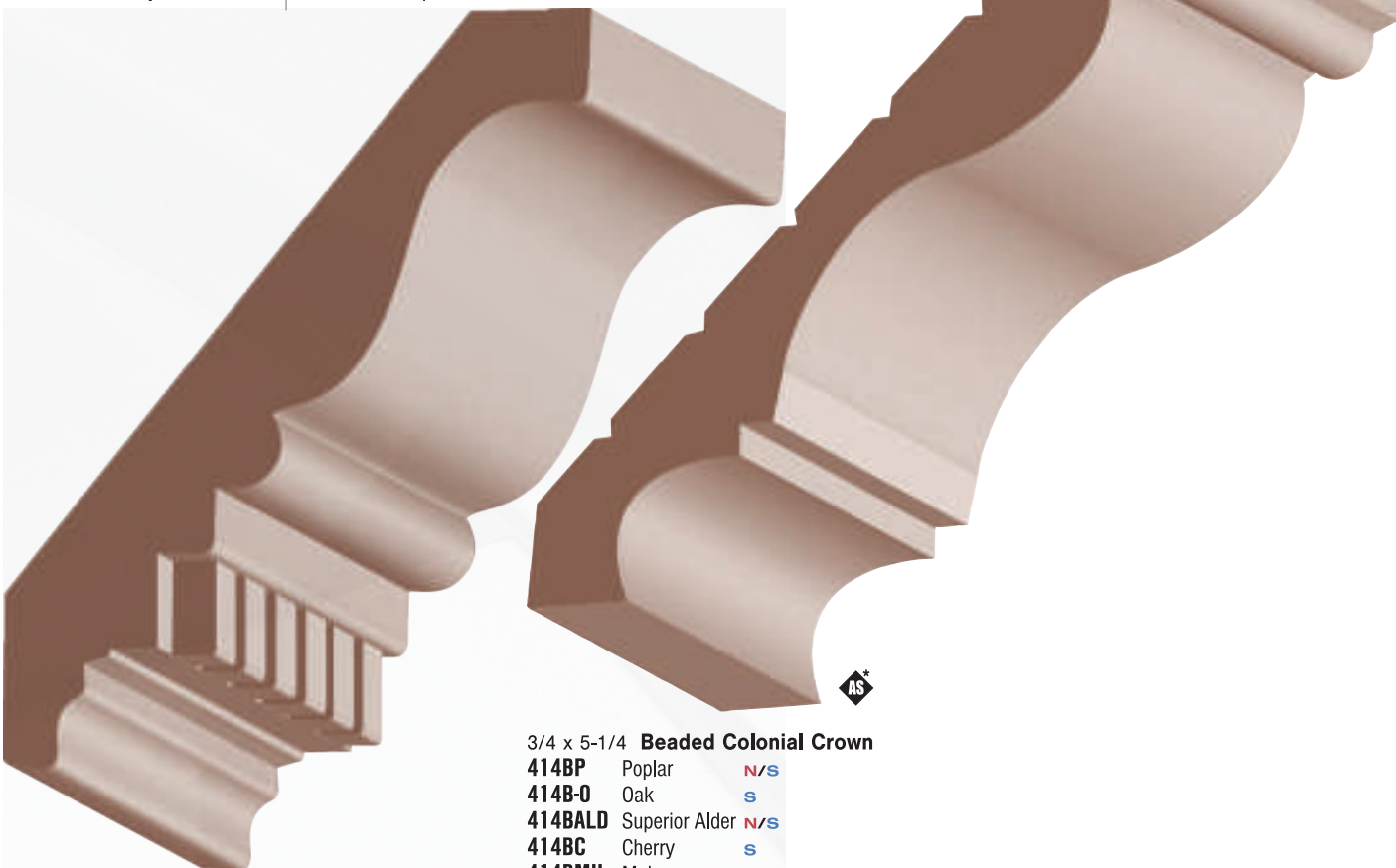

3/4 x 5 **Dentil Crown**

CR864P	Poplar	S
---------------	--------	---

3/4 x 5-1/4 **Beaded Colonial Crown**

414BP	Poplar	N/S
414B-0	Oak	S
414BALD	Superior Alder	N/S
414BC	Cherry	S
414BMH	Mahogany	S
414BMP	Maple	S



5-1/4" to 5-1/2" Crown

(items are approximate scale only)

lengths available: 6' thru 16'



13/16 x 5-1/4 **Madison Crown**
C0705P Poplar [S](#)

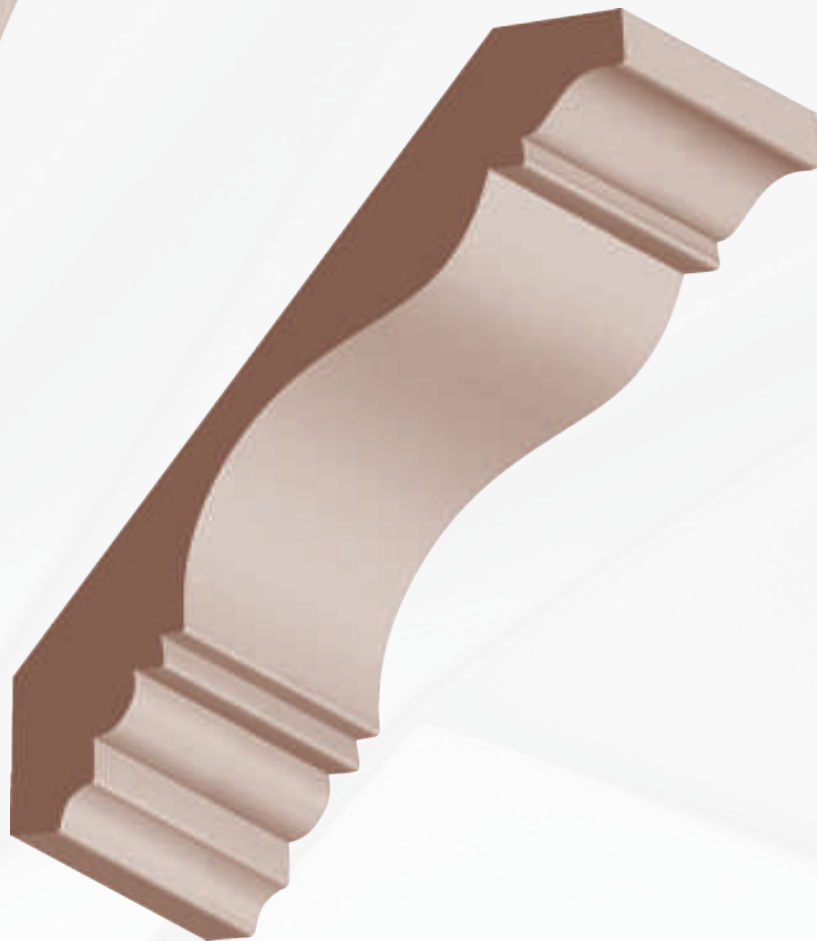

11/16 x 5-1/2 **Covington Crown**
CR806P Poplar [S](#)



(items are approximate scale only)

5-1/4" to 5-1/2" Crown

lengths available: 6' thru 16'

AS
ALL SPECIES

AS*
ALL SPECIES
EXCEPT KNOTTY ALDER

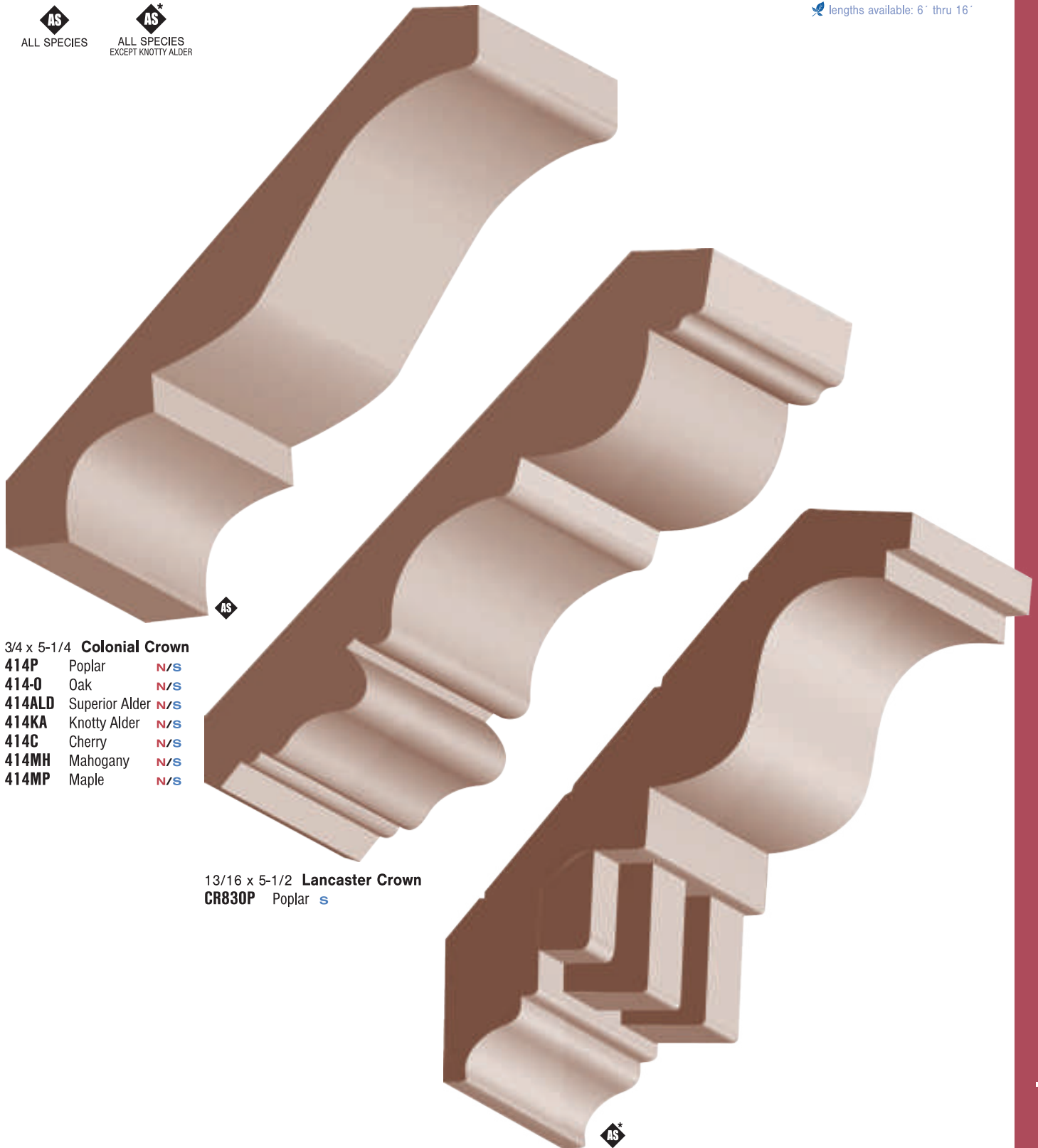

3/4 x 5-1/4 **Colonial Crown**

414P	Poplar	N/S
414-O	Oak	N/S
414ALD	Superior Alder	N/S
414KA	Knotty Alder	N/S
414C	Cherry	N/S
414MH	Mahogany	N/S
414MP	Maple	N/S

13/16 x 5-1/2 **Lancaster Crown**
CR830P Poplar **S**

13/16 x 5-1/2 **Dentil Crown**

CM73P	Poplar	N/S
CM73-O	Oak	N/S
CM73ALD	Superior Alder	N/S
CM73C	Cherry	N/S
CM73MH	Mahogany	N/S
CM73MP	Maple	N/S



5-1/2" to 6" Crown

(items are approximate scale only)

✦ lengths available: 6' thru 16'

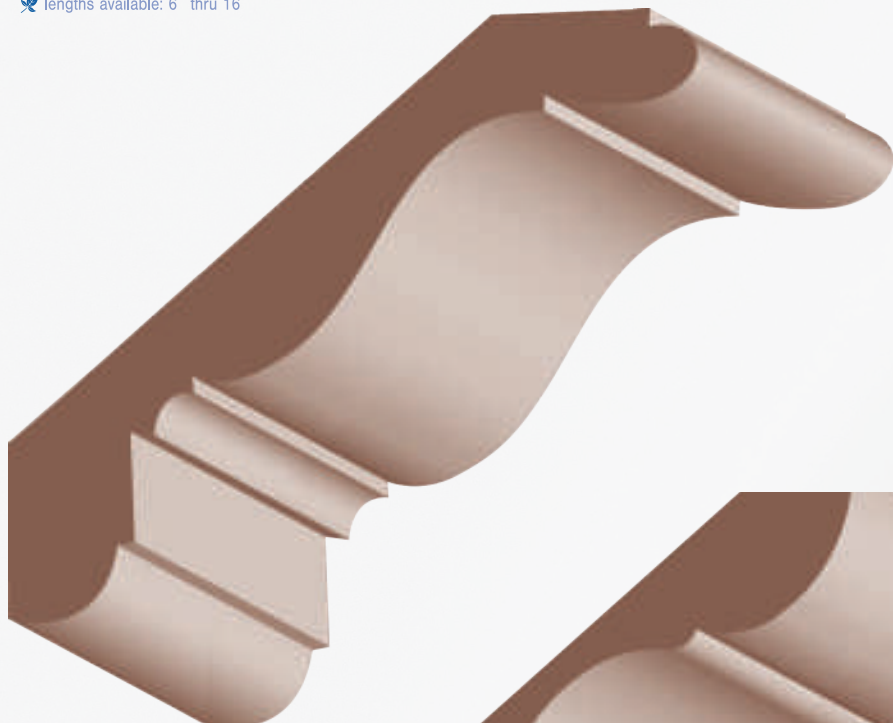

- 1-1/8 x 6 **Cornice**
- 408P Poplar \$
 - 408-O Oak \$
 - 408C Cherry N/S
 - 408MH Mahogany N/S
 - 408MP Maple N/S

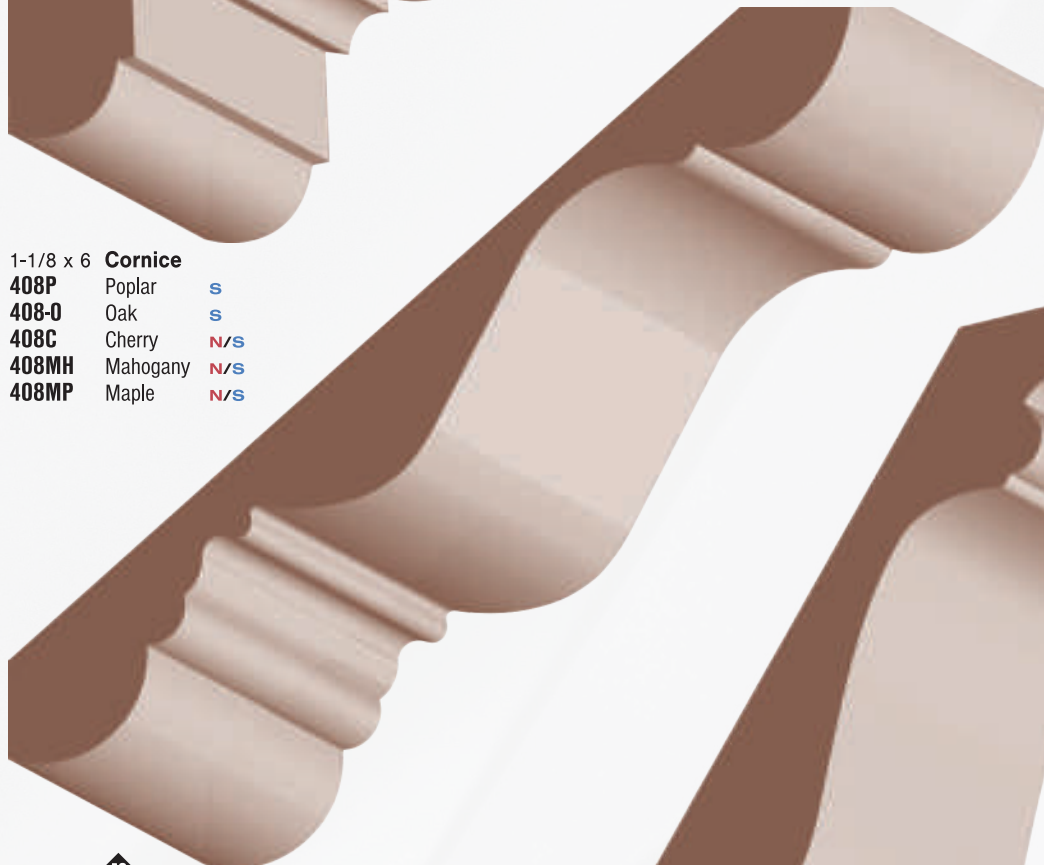

- 3/4 x 6 **Charleston Crown**
- 410P-6 Poplar N/S
 - 410-O6 Oak N/S
 - 410ALD-6 Superior Alder N/S
 - 410KA-6 Knotty Alder N/S
 - 410C-6 Cherry N/S
 - 410MH-6 Mahogany N/S
 - 410MP-6 Maple N/S

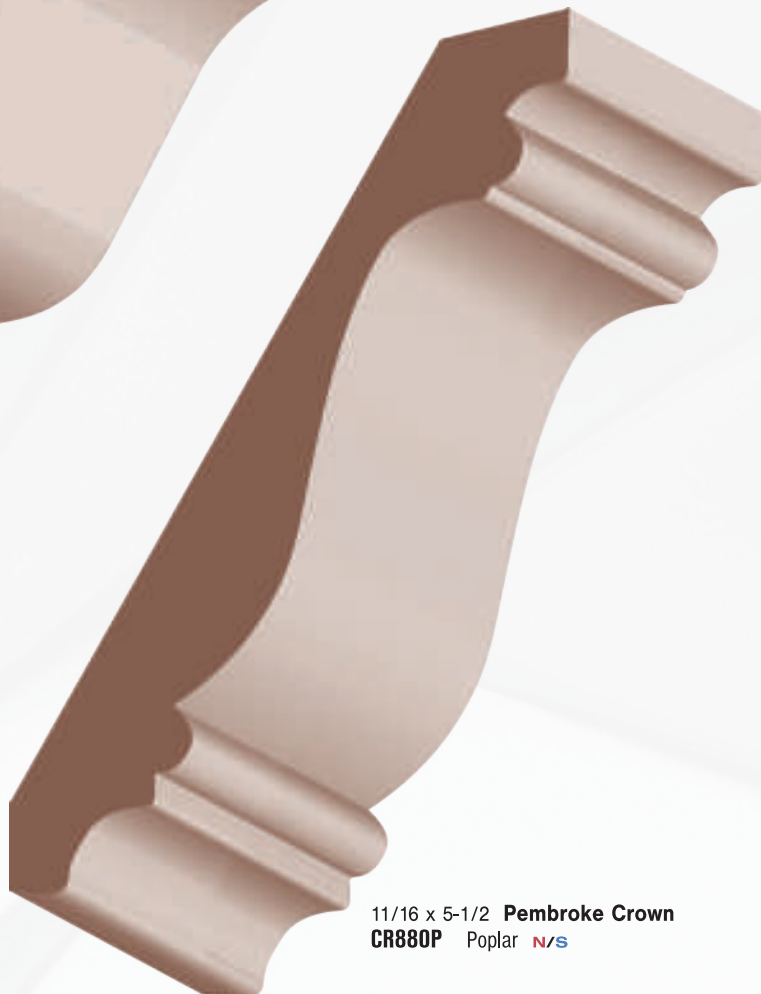

- 11/16 x 5-1/2 **Pembroke Crown**
CR880P Poplar N/S



(items are approximate scale only)

6-1/4" to 6-1/2" Crown

✂ lengths available: 6' thru 16'

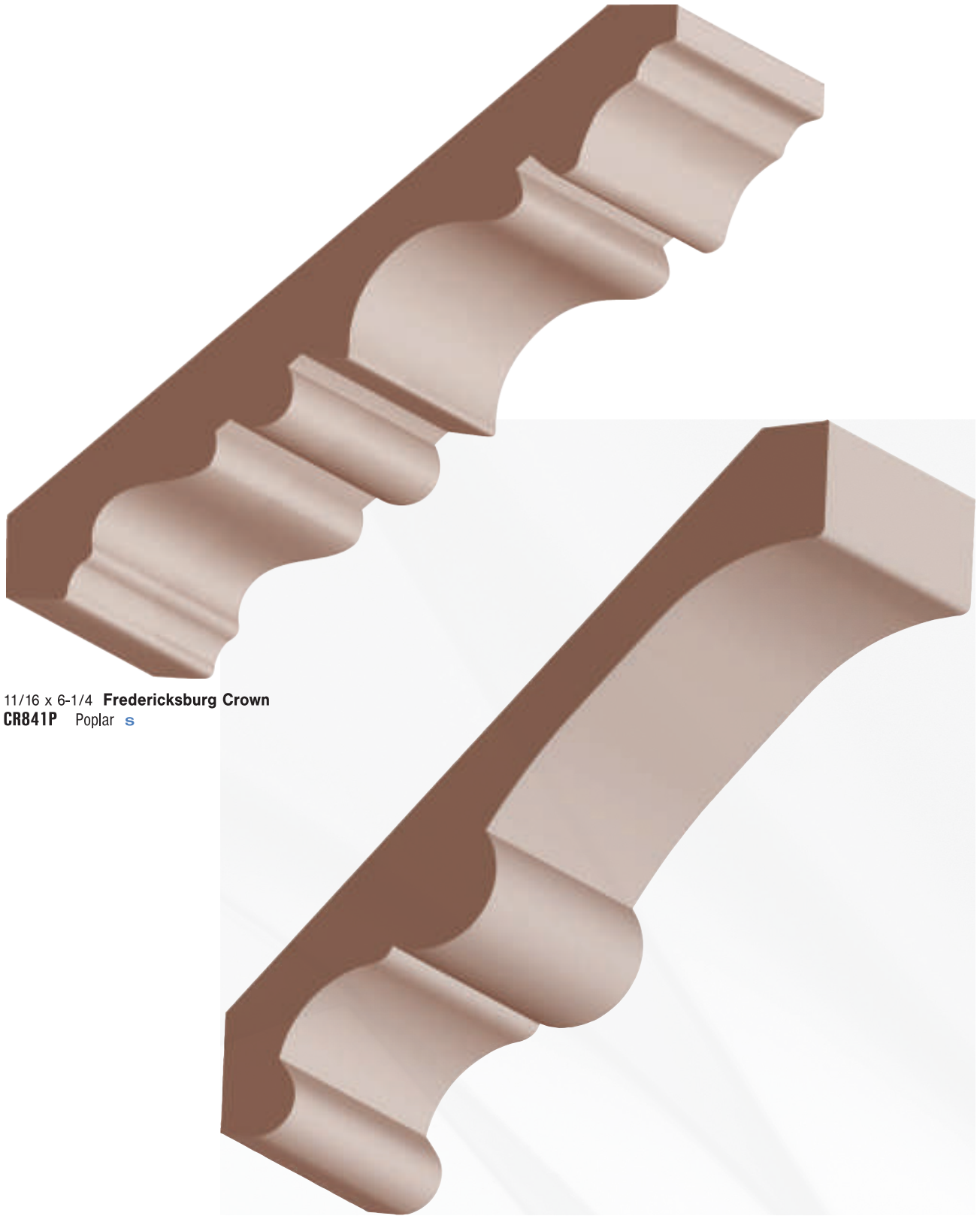

11/16 x 6-1/4 **Fredericksburg Crown**
CR841P Poplar **S**

7/8 x 6-1/2 **Single Beaded Crown**
443P Poplar **N**



6-1/2" Crown

lengths available: 6' thru 16'

(items are approximate scale only)

AS
ALL SPECIES
EXCEPT KNOTTY ALDER

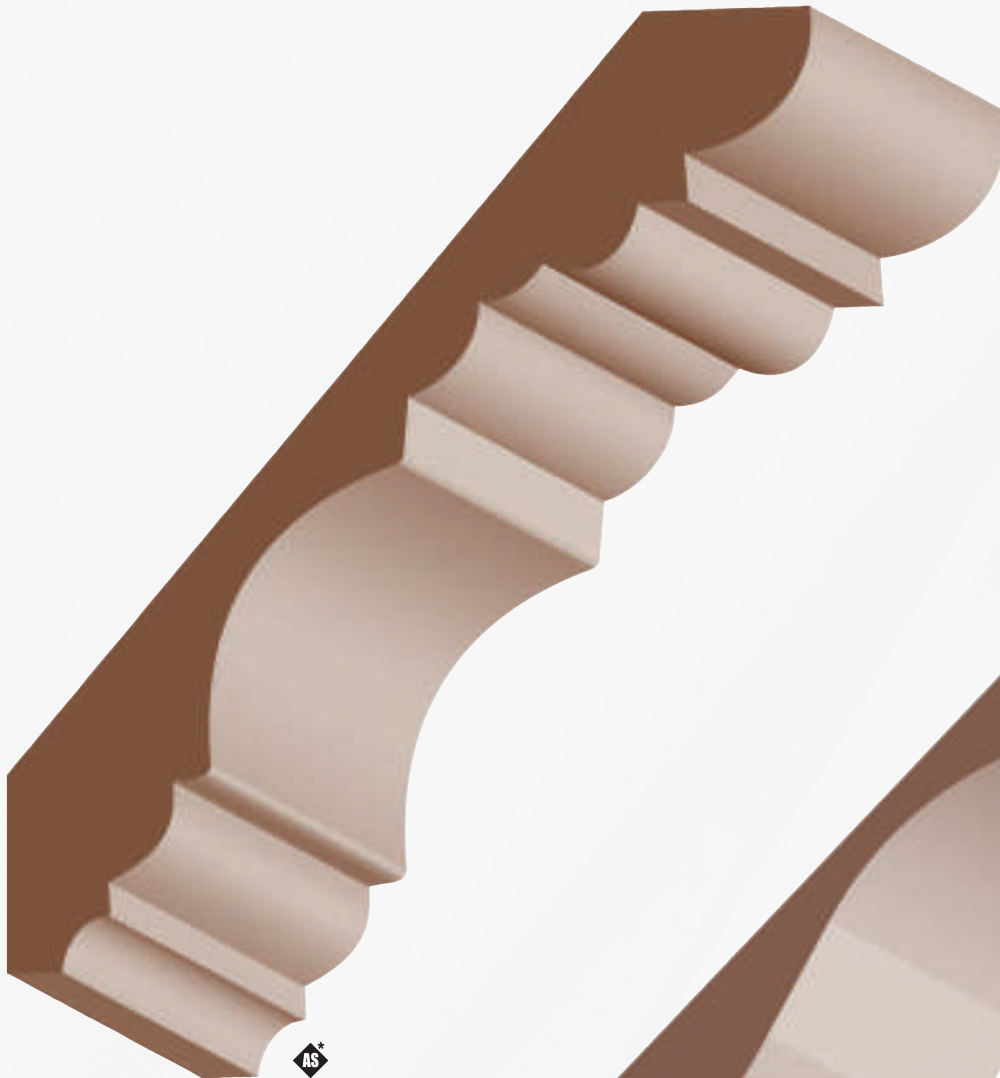

AS

7/8 x 6-1/2" **Coronado/Georgian Crown**

- 427P** Poplar N/S
- 427-O** Oak N/S
- 427ALD** Superior Alder N/S
- 427C** Cherry N/S
- 427MH** Mahogany N/S
- 427MP** Maple N/S

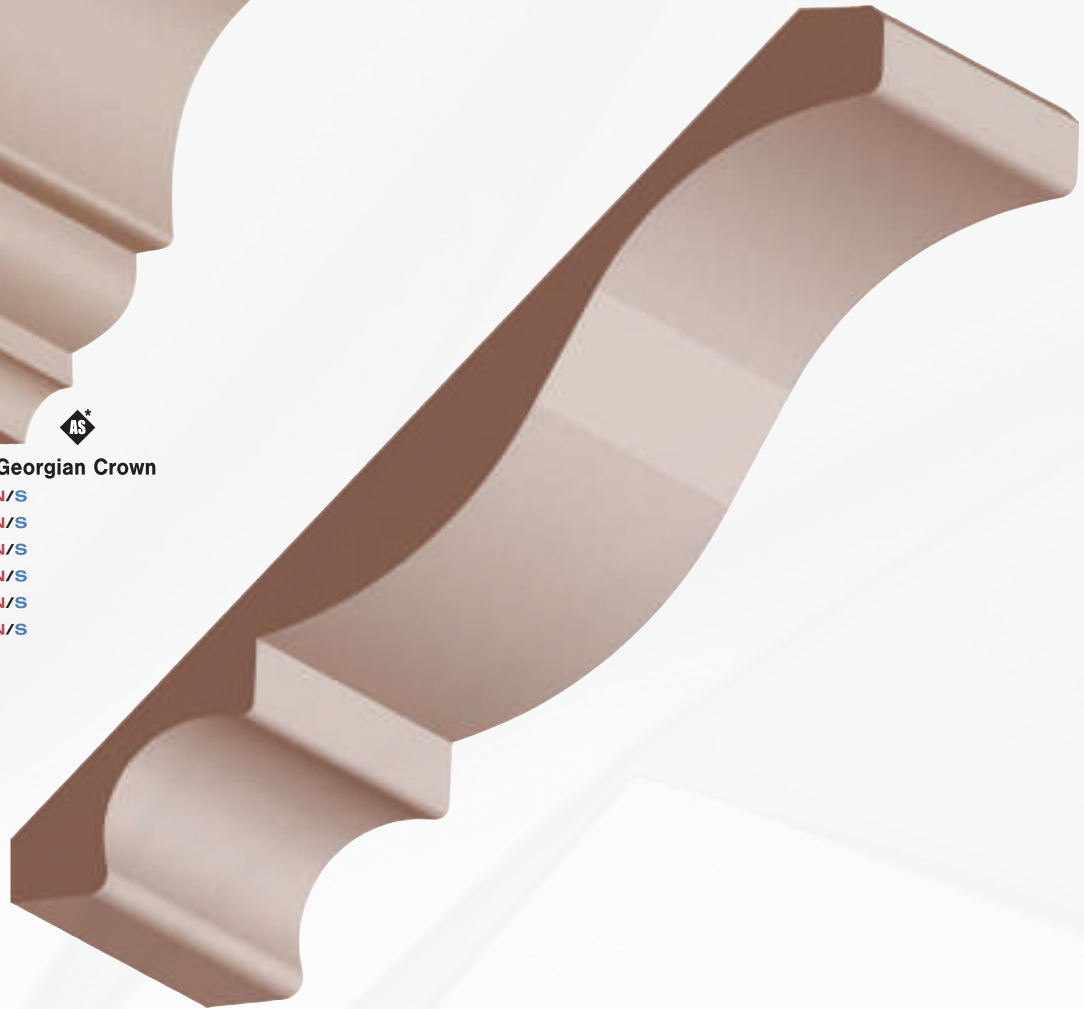

3/4 x 6-1/2" **Colonial Crown**
416P Poplar N/S



(items are approximate scale only)

6-1/2" to 6-7/8" Crown

lengths available: 6' thru 16'

AS
ALL SPECIES



AS

1-1/8 x 6-1/2 **Double Bead Carolina Crown**
(Not to Scale)

424P-6	Poplar	N/S
424-O6	Oak	N
424ALD-6	Superior Alder	N/S
424KA-6	Knotty Alder	N
424C-6	Cherry	N
424MH-6	Mahogany	N
424MP-6	Maple	N

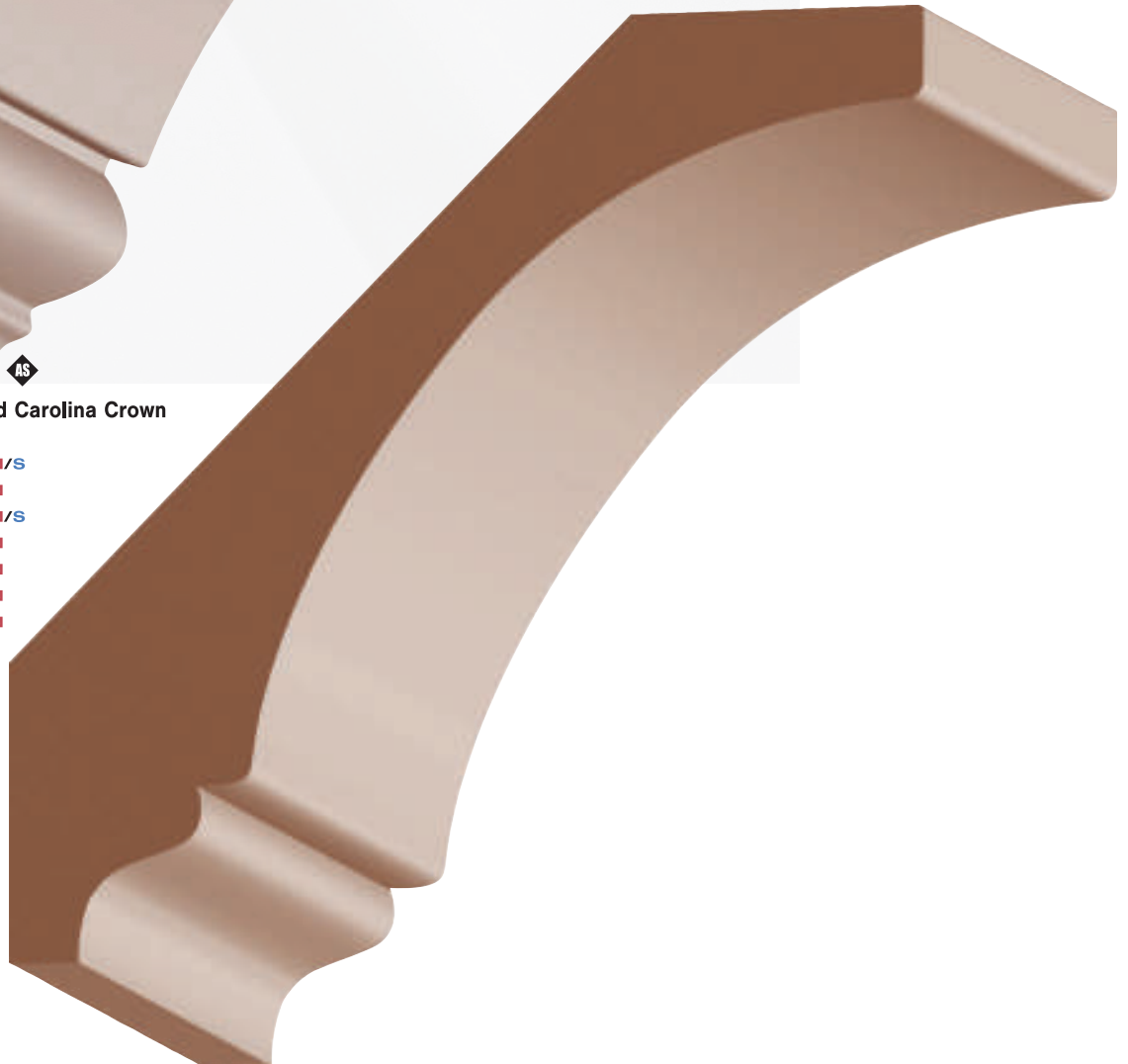

1-1/4 x 6-7/8 **Reale Crown**
456P Poplar N



7" Crown

lengths available: 6' thru 16'

(items are approximate scale only)

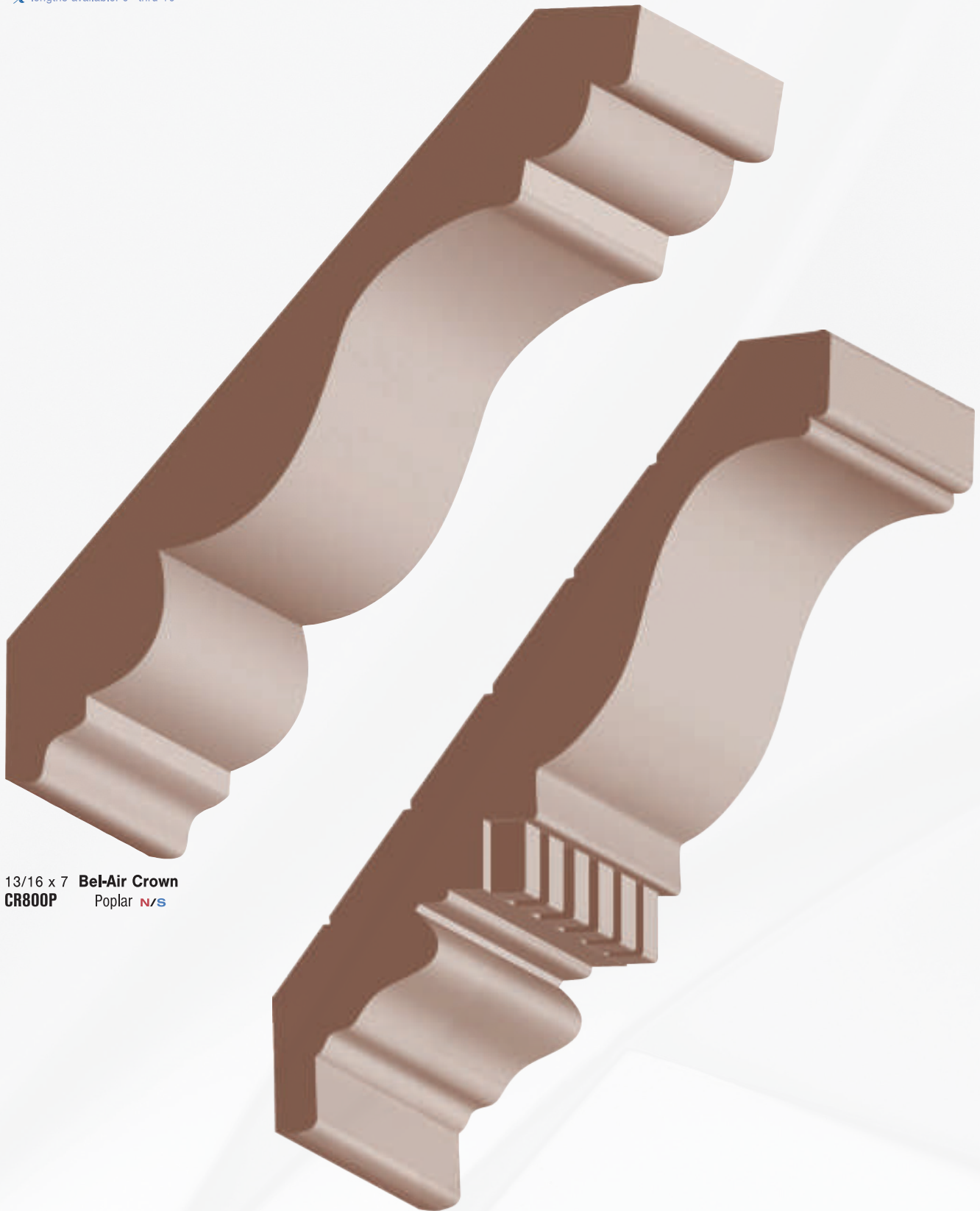

13/16 x 7 **Bel-Air Crown**
CR800P Poplar *N/S*

13/16 x 7 **Dentil Crown**
CR862P Poplar *N/S*
CR862-0 Oak *S*



(items are approximate scale only)

7-1/4" Crown

lengths available: 6' thru 16'

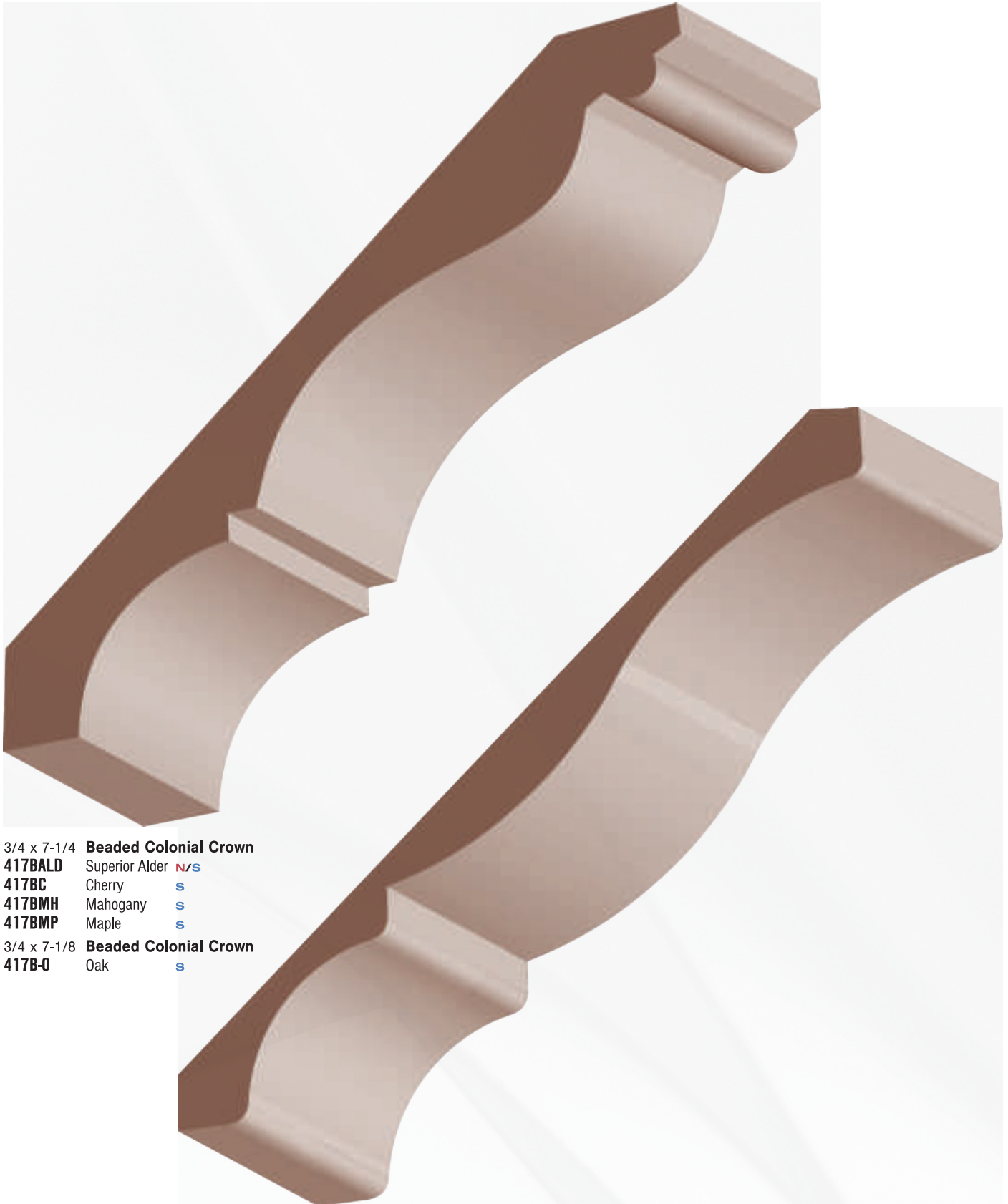

3/4 x 7-1/4 **Beaded Colonial Crown**

- 417BALD** Superior Alder N/S
- 417BC** Cherry S
- 417BMH** Mahogany S
- 417BMP** Maple S

3/4 x 7-1/8 **Beaded Colonial Crown**

- 417B-0** Oak S

3/4 x 7-1/4 **Colonial Crown**

- 417P** Poplar N/S
- 417ALD** Superior Alder S



8" to 9-5/8" Crown

(items are approximate scale only)

lengths available: 6' thru 16'

1 x 8 Charleston Crown

- 410P-8** Poplar N/S
- 410C-8** Cherry S
- 410MH-8** Mahogany S
- 410MP-8** Maple S

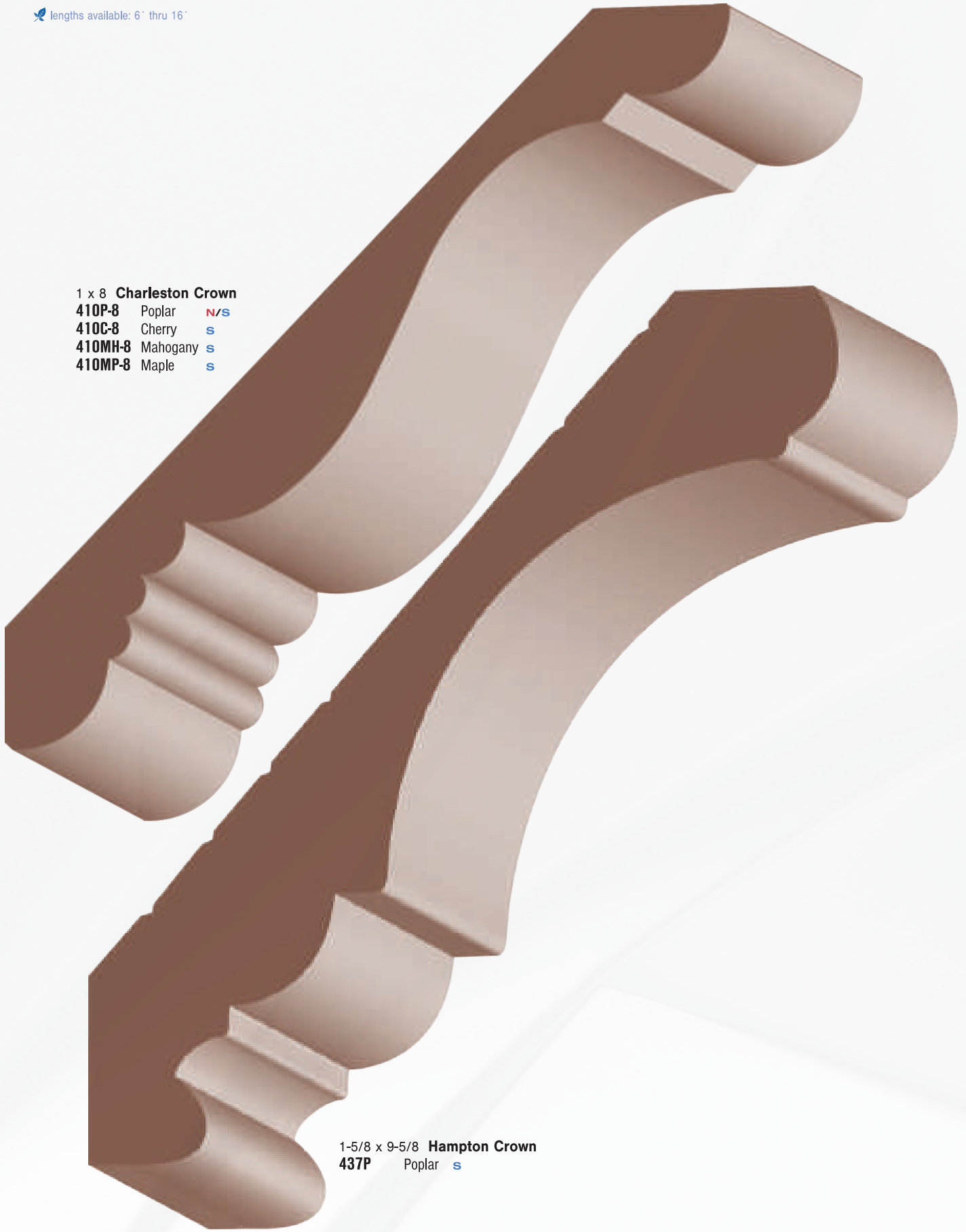

1-5/8 x 9-5/8 Hampton Crown

- 437P** Poplar S



(items are approximate scale only)

Dentil Lineal

lengths available: 6' through 16'

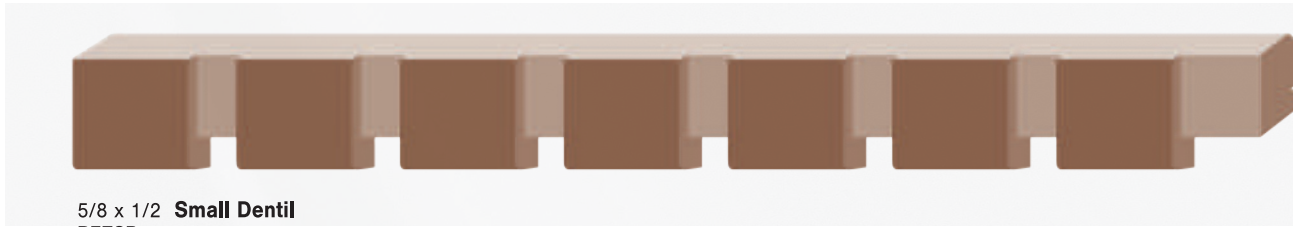

5/8 x 1/2 **Small Dentil**
DE73P Poplar **N/S**



1/2 x 1/2 **Dentil**
DE168P Poplar **S**



15/16 x 5/8 **Large Dentil**
DE74P Poplar **N/S**



3/4 x 1 **Dentil**
DE169P Poplar **S**



5/8 x 1-1/2 **Dentil**
DE170P Poplar **S**

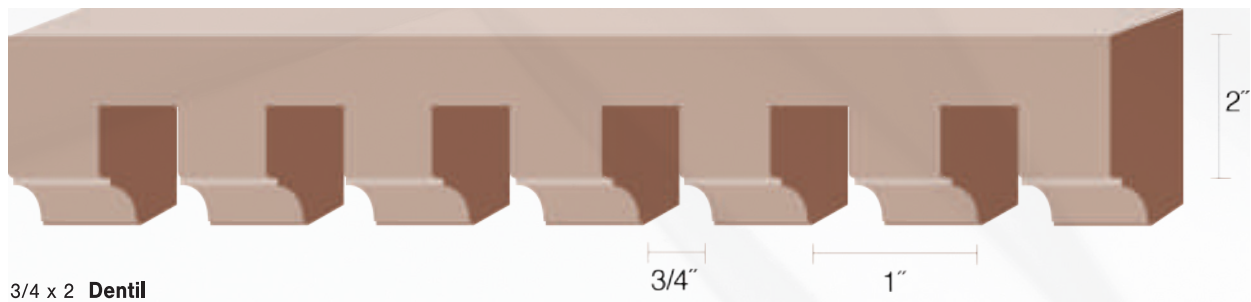

3/4 x 2 **Dentil**
DE171P Poplar **S**
DE171-O Oak **S**

Screen & Pencil Molds

lengths available: 6" through 16"



1/4 x 3/4 Flat Screen Mold
591P Poplar *N/S*
591-0 Oak *N/S*



3/16 x 3/4 Scribe Mold **AS***
593P Poplar *N/S* **593C** Cherry *N/S*
593-0 Oak *N/S* **593MH** Mahogany *N/S*
593ALD Superior Alder *N/S* **593MP** Maple *N/S*



3/8 x 3/4 Cloverleaf **AS***
594P Poplar *N/S*
594-0 Oak *N/S*
594ALD Superior Alder *N/S*
594C Cherry *N/S*
594MH Mahogany *N/S*
594MP Maple *N/S*



3/8 x 3/4 Bead Mold
598P Poplar *N*



1/2 x 7/8 Beveled Full-Lip Bead
580-0 Oak *S*
580MP Maple *S*



3/4 x 3/4 Pencil Mold
680P Poplar *N*



3/8 x 11/16 Flush Bead
581-0 Oak *S*
581MP Maple *S*



3/4 x 1-1/16 Flat Full-Lip Bead
582-0 Oak *S*
582MP Maple *S*



1/2 x 23/32 Beveled Flush Bead
583-0 Oak *S*
583MP Maple *S*

Cove

(items are approximate scale only)

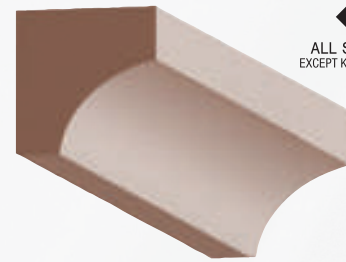

AS*
 ALL SPECIES
 EXCEPT KNOTTY ALDER

3/4 x 3/4 Cove **AS***

523P Poplar *N/S* **523C** Cherry *N/S*
523-0 Oak *N/S* **523MH** Mahogany *N/S*
523ALD Superior Alder *N/S* **523MP** Maple *N/S*



1/2 x 1/2 Cove **AS***

521P Poplar *N/S*
521-0 Oak *S*
521ALD Superior Alder *N/S*
521C Cherry *N/S*
521MH Mahogany *N/S*
521MP Maple *N/S*

Quarter / Half / Full Round

lengths available: 6" through 16"



1/2 x 1/2 Quarter Round
502P Poplar *N/S*
502-0 Oak *N/S*
502C Cherry *N/S*
502MH Mahogany *N/S*
502MP Maple *N/S*



3/8 x 3/4 Half Round
572P Poplar *N/S*
572-0 Oak *N/S*
572C Cherry *N/S*
572MH Mahogany *N/S*
572MP Maple *N/S*

3/4 x 3/4 Quarter Round **AS***
504P Poplar *N/S*
504-0 Oak *N/S*
504ALD Superior Alder *N/S*
504C Cherry *N/S*
504MH Mahogany *N/S*
504MP Maple *N/S*

3/4 x 1-1/2 Half Round
575P Poplar *N/S*
1 x 2 Half Round
576P Poplar *N/S*



1-3/8 Full Round
803-0 Oak *N/S*



(items are approximate scale only)

Panel Mold & Cap

lengths available: 6' thru 16'



ALL SPECIES
EXCEPT KNOTTY ALDER



3/8 x 5/8 **Panel Mold**
600-0 Oak **S**



9/16 x 3/4 **Base Cap**

612P	Poplar	N	612C	Cherry	N
612-0	Oak	N	612MH	Mahogany	N
612ALD	Superior Alder	N	612MP	Maple	N



5/8 x 3/4 **Panel Mold**
601-0 Oak **S**



5/8 x 7/8 **Mantel Panel Mold**
635P Poplar **S**
635-0 Oak **S**



3/4 x 1 **Panel Mold**
602-0 Oak **N/S**
602ALD Superior Alder **N/S**



7/8 x 1 **Panel Mold**

630P	Poplar	S	630C	Cherry	S
630-0	Oak	S	630MH	Mahogany	S
630ALD	Superior Alder	S	630MP	Maple	S

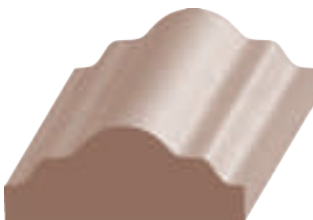

1/2 x 1-1/4 **Panel Mold**
629P Poplar **S**

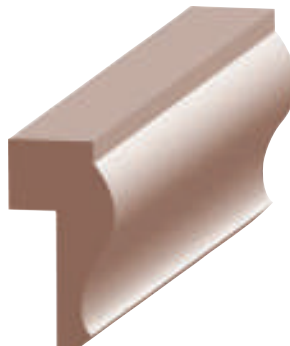

9/16 x 1-1/8 **Panel Cap**
[with 3/4" Rab't]
624-0 Oak **N**

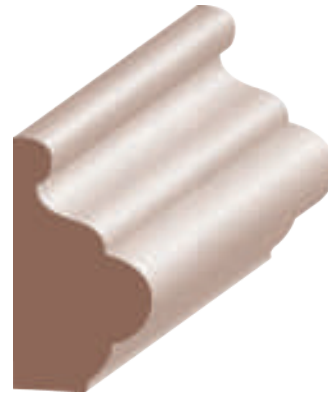

3/4 x 1-5/16 **Panel Mold**

631P	Poplar	S	631C	Cherry	S
631-0	Oak	S	631MH	Mahogany	S
631ALD	Superior Alder	S	631MP	Maple	S



3/4 x 1-5/8 **Panel Mold**
605-0 Oak (11/16 x 1-5/8) **S**
605ALD Superior Alder **N/S**



9/16 x 1-3/8 **Panel Mold**
606-0 Oak **S**

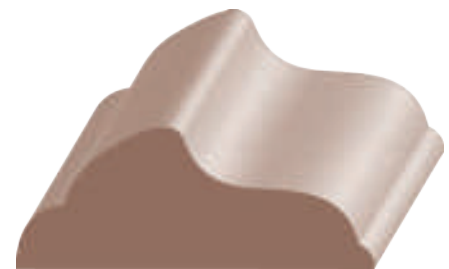

3/4 x 1-7/8 **Beauty Mold**
608-0 Oak **S**



Panel Cap

lengths available: 6' thru 16'

(items are approximate scale only)

AS*
ALL SPECIES
EXCEPT KNOTTY ALDER

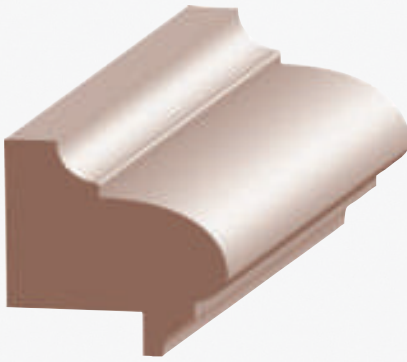

1-1/8 x 1-3/16 **Panel Cap**
[with 3/4" Rab't]

623P Poplar **N**

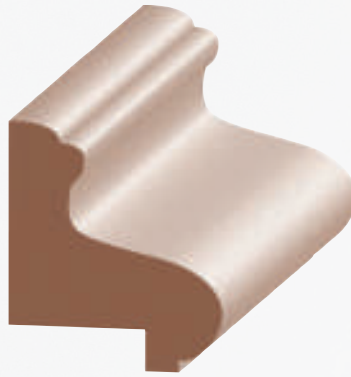

1-1/8 x 1-1/4 **Raised Panel Cap**
[with 3/4" Rab't]

613-0 Oak **N/S**
613P Poplar **S**



3/4 x 1-1/4 **Raised Panel Cap** **AS***
[with 1/2" Rab't]

632P Poplar S	632C Cherry S
632-0 Oak S	632MH Mahogany S
632ALD Superior Alder S	632MP Maple S

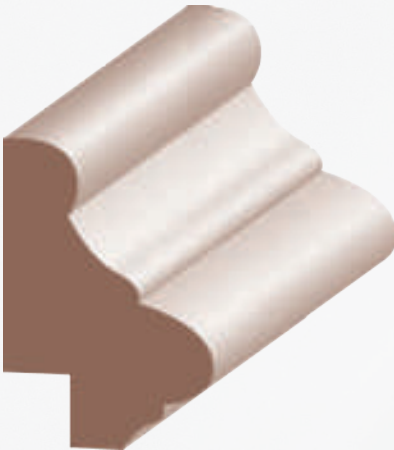

1-1/8 x 1-5/8 **Panel Cap**
[with 3/8" Rab't]

732-0 Oak **S**



3/4 x 1-11/16 **Base Cap**

625P Poplar **S**



11/16 x 1-3/8 **Coronado Base Cap** **AS***

614P Poplar N/S	614C Cherry N/S
614-0 Oak N/S	614MH Mahogany N/S
614ALD Superior Alder N	614MP Maple N/S



11/16 x 1-1/2 **Decorative Base Cap**

628P Poplar **S**
628-0 Oak **S**
628C Cherry **S**
628MH Mahogany **S**
628MP Maple **S**



1/2 x 1-1/2 **Panel Cap**

[with 1/4" Rab't]
730-0 Oak **S**



11/16 x 1-3/4 **Panel Cap**
[with 1/4" Rab't]

616P Poplar **N/S**



(items are approximate scale only)

Panel Mold / Cap

lengths available: 6' thru 16'

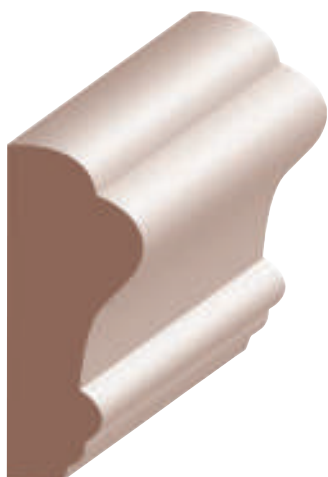

11/16 x 1-3/4 **Panel Cap**
617P Poplar **N/S**

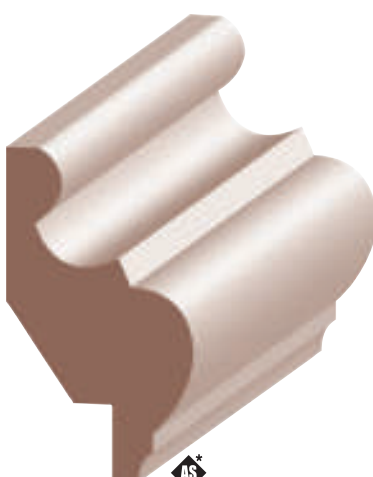

3/4 x 1-3/4 **Panel Cap**
[with 1/2" Rab't]

- 620P Poplar **N/S**
- 620-O Oak **N/S**
- 620ALD Superior Alder **N/S**
- 620C Cherry **N/S**
- 620MH Mahogany **N/S**
- 620MP Maple **N/S**

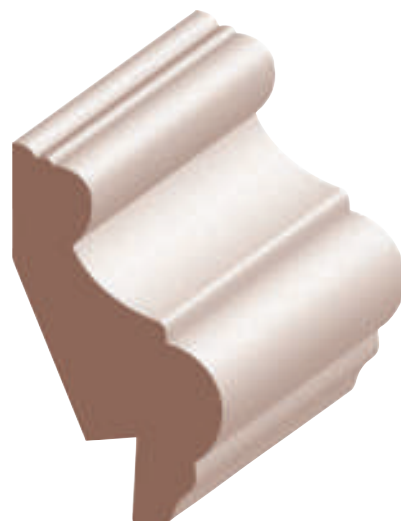

1-1/8 x 2 **Panel Cap**
[with 1/2"-5/8" Rab't]
615P Poplar **N/S**



3/4 x 2 **Panel Mold**
618P Poplar **S**



13/16 x 2 **Panel Cap** [with 3/4" Rab't]
621ALD Superior Alder **N/S**

- 3/4 x 2 **Panel Cap** [with 3/4" Rab't]
- 621P Poplar **N/S**
- 621-O Oak **N/S**
- 621C Cherry **N/S**
- 621MP Maple **N/S**
- 621MH Mahogany **N/S**



Panel Cap

lengths available: 6' thru 16'

(items are approximate scale only)

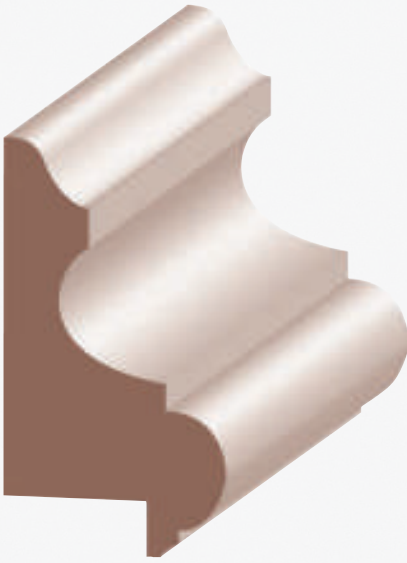

1-3/16 x 2-3/16 **Raised Panel Cap**
[with 3/4" Rab't]
611P Poplar **N**



9/16 x 2-1/4 **Wainscot Cap**
[with 3/8" Rab't]
729BP Poplar **N**



11/16 x 2-3/8 **Panel Cap**
[with 9/16" Rab't]
619P Poplar **S**



3/4 x 2-5/16 **Panel Cap**
[with 1/4" Rab't]
622P Poplar **S**



3/4 x 2-5/16 **T&G Cap**
[with 1/4" Rab't]
622ALD Superior Alder **N/S**



(items are approximate scale only)

Chair Rail

lengths available: 6' thru 16'

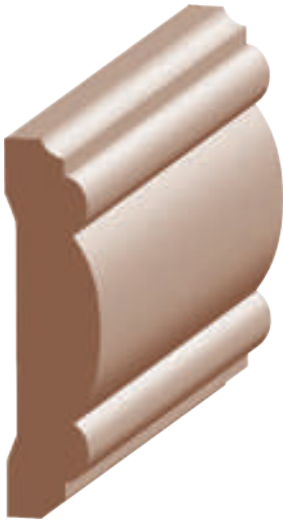

1/2 x 2 **Bead & Barrel Chair Rail**
648P Poplar **S**
648-0 Oak **S**



1/2 x 2-1/2 **Chair Rail**
651-0 Oak **N/S**



5/8 x 2-5/8 **Colonial Chair Rail**
655P Poplar **N**
655-0 Oak **N/S** [FORMERLY 652-0]

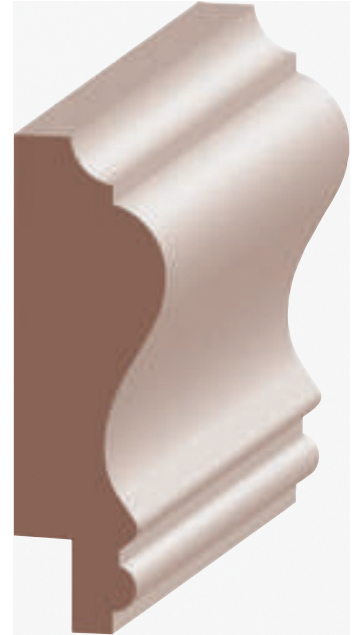

13/16 x 2-5/8 **Chair Rail**
 [with 3/8" Rab't]
659P Poplar **N**
659-0 Oak **N**



1/2 x 2-7/8 **Beaded Chair Rail**
658-0 Oak **S**



3/4 x 3 **Bead & Barrel Chair Rail**
649P Poplar **N/S**
649ALD Superior Alder **S**



3/4 x 3 **Colonial Chair Rail**
653P Poplar **S**
653-0 Oak **N/S**
653C Cherry **N/S**
653MH Mahogany **N/S**
653MP Maple **N/S**



Chair Rail

(items are approximate scale only)

✦ lengths available: 6' thru 16'



3/4 x 3 **Chair Rail**
[with 1/2" Rad']
654P Poplar **S**



3/4 x 3-1/4 **Chair Rail**
656P Poplar **S**



11/16 x 4-1/4 **Victorian Casing/Chair Rail**
184-0 Oak **S**

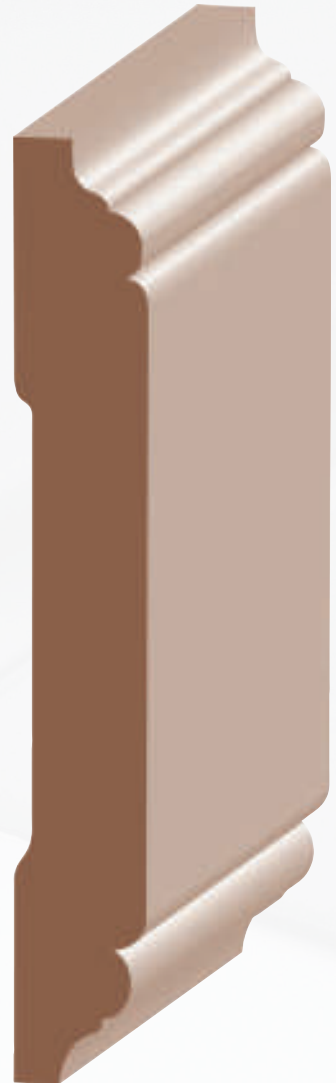

11/16 x 5 **Chair Rail**
693P Poplar **N**



(items are approximate scale only)

T&G Wainscot

lengths available: 6' thru 16'



3/8 x 3-3/8 **Reversible Beaded/Flat T&G Wainscot**

- R2000P** Poplar N/S
- R2000-O** Oak (3/8 x 3-1/2) N/S
- R2000ALD** Superior Alder N/S

FLAT



5/16 x 3-3/8 **Beaded Shiplap T&G**

- 2003ALD** Superior Alder N/S



9/16 x 3-1/4 **Wainscot Base**

[with 3/8" Rab't]

- 735P** Poplar S



9/16 x 5 **T&G Wainscot Base**

[with 3/8" Rab't]

- 736ALD** Superior Alder N/S



Astragal

lengths available: 6' thru 12'

(items are approximate scale only)

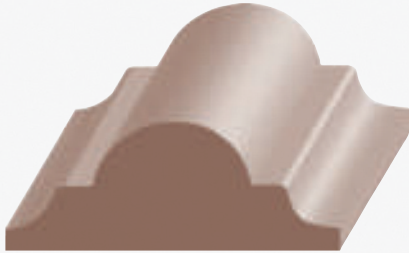

3/4 x 1-5/8 **Flat Astragal/Panel Mold**

646P	Poplar	N
646-O	Oak	N
646ALD	Superior Alder	N
646C	Cherry	N

660P	Poplar	S
660-O	Oak	S
660ALD	Superior Alder	S
660C	Cherry	S
660MH	Mahogany	S
660MP	Maple	S

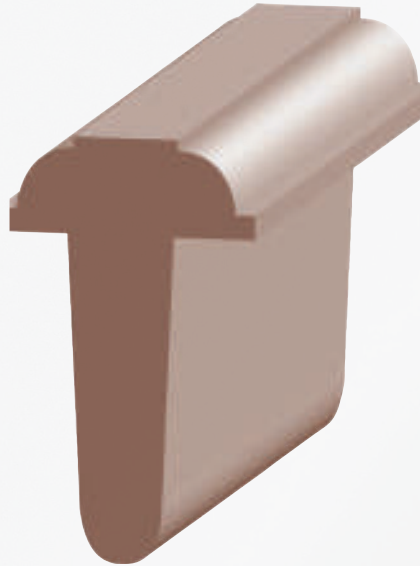

1-1/4 x 2-1/4 **T-Astragal for 1-3/4" Doors**

661P	Poplar	N/S
661-O	Oak	N/S
661ALD	Superior Alder	N/S
661C	Cherry	N/S
661MH	Mahogany	N/S

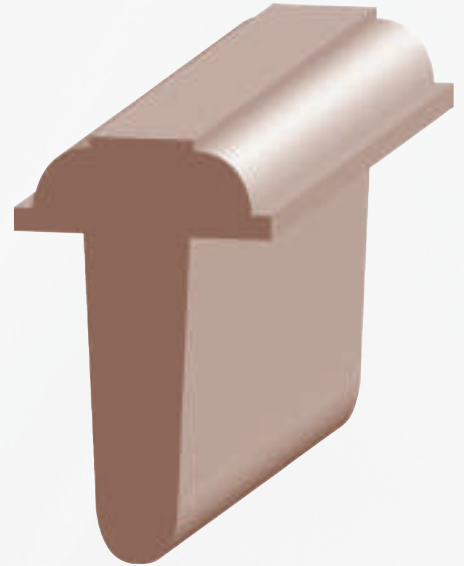

1-1/4 x 2 **T-Astragal for 1-3/8" Doors**

662-O	Oak	N/S
662ALD	Superior Alder	N/S
662C	Cherry	N

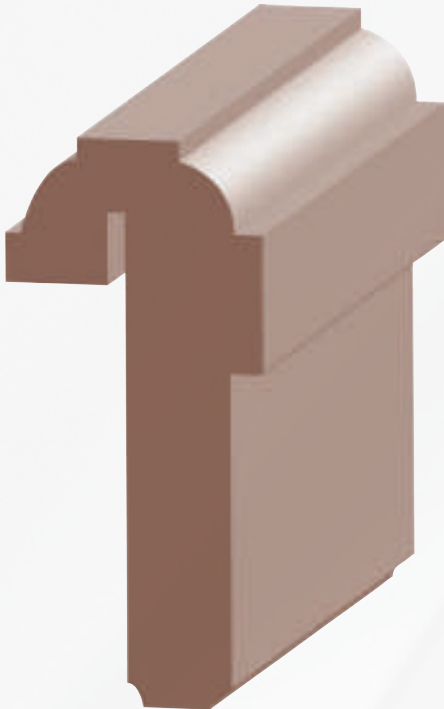

1-3/8 x 3 **T-Astragal w/Weatherstrip Kerf for 1-3/4" Doors**

663P	Poplar	N/S
663-O	Oak	N/S
663ALD	Superior Alder	N/S
663C	Cherry	N/S
663MH	Mahogany	N/S



1-1/2 x 3-1/8 **T-Astragal w/Weatherstrip Kerf**

667P	Poplar	N/S
667MH	Mahogany	N/S
667WL	Walnut	N/S
667QWO	Quarter Sawn White Oak	N/S

1-5/8 x 3 **Thick T-Astragal w/Weatherstrip Kerf for 1-3/4" Doors**

663BP	Poplar	S
663B-O	Oak	S
663BALD	Superior Alder	S
663BMH	Mahogany	S



(items are approximate scale only)



Exterior Mold

lengths available: 6' through 16'

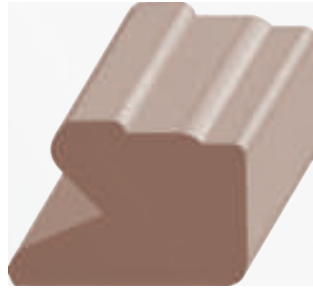

7/8 x 1-1/4 **Stucco Mold**

826-0	Oak	S
826ALD	Superior Alder	S
826MH	Mahogany	S

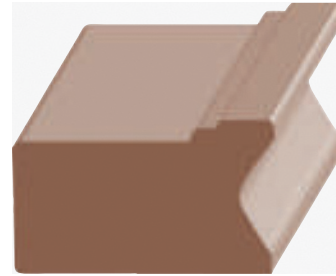

13/16 x 1-3/8 **Stucco Mold**

833-0	Oak	N
833ALD	Superior Alder	N
833C	Cherry	N
833MH	Mahogany	N



1-1/8 x 2 **#180 Eastern Brick Mold without Stucco Key**

612A-0	Oak	N/S
612AALD	Superior Alder	N/S
612AC	Cherry	N/S
612AMH	Mahogany	N/S



1-1/8 x 2 **#180 Eastern Brick Mold w/Stucco Key**

612B-0	Oak	N/S
612BALD	Superior Alder	N/S
612BC	Cherry	N/S
612BMH	Mahogany	N/S

Outside Corner Guard

lengths available: 6' thru 16'



3/4 x 3/4 **Outside Corner Guard**
720-0 Oak N/S



1 x 1 **Outside Corner Guard**

721P	Poplar	N/S
721-0	Oak	N/S
721ALD	Superior Alder	N/S
721C	Cherry	N/S
721MH	Mahogany	N/S
721MP	Maple	N/S



1-1/8 x 1-1/8 **Detail Outside Corner Guard**

723P	Poplar	N/S
723-0	Oak	N/S
723C	Cherry	N/S
723MH	Mahogany	N/S
723MP	Maple	N/S



Handrail

(items are approximate scale only)

lengths available: 6' thru 16'



3/8 x 1-1/4 **Fillet**
951P Poplar **S**
951-0 Oak **S**



3/4 x 2-1/2 **Shoe Rail**
w/ 1/4" x 1-1/4" Plow
950P Poplar **S**
950-0 Oak **S**

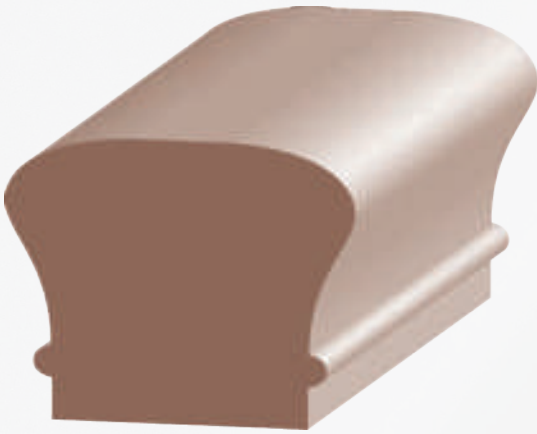

1-1/2 x 1-7/8 **Small #6010 Handrail**
932P Poplar **S**

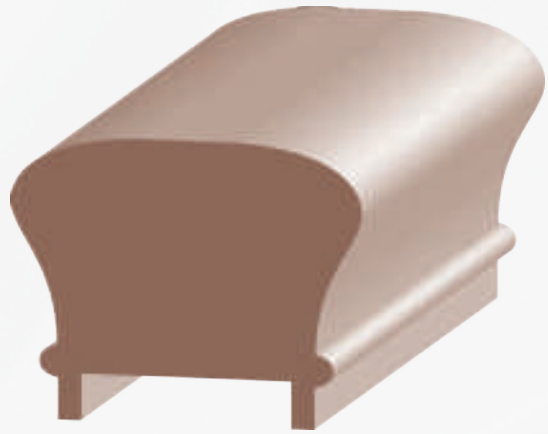

1-1/2 x 1-7/8 **Small #6010 Handrail**
w/ 1/4" x 1-1/8" Plow
932PPL Poplar **S**

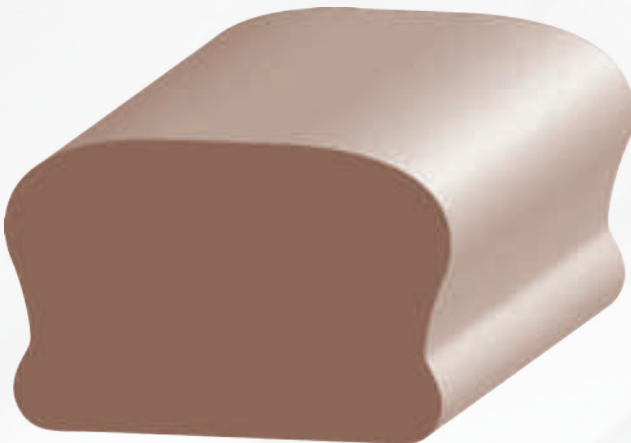

1-1/2 x 2-3/8 **Standard Handrail**
925-0 Oak **S**

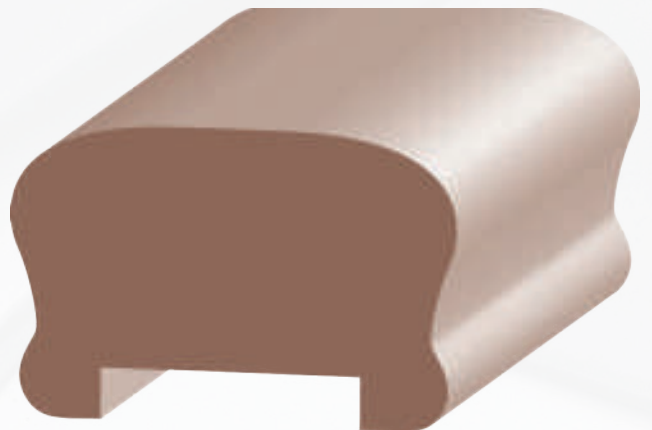

1-1/2 x 2-3/8 **Standard Handrail**
w/ 1/4" x 1-1/4" Plow
925-0PL Oak **S**



(items are approximate scale only)

Handrail

lengths available: 6' thru 16'

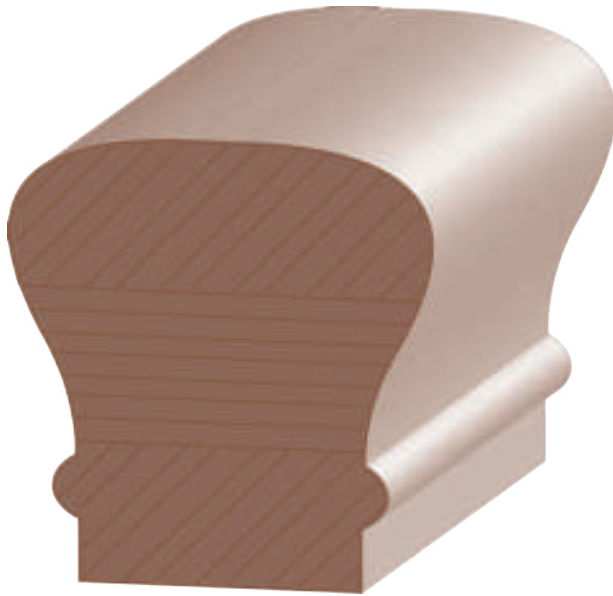

2-1/4 x 2-3/8 **Classic #6010 Handrail**
(3pc Glue Up)
931P Poplar **S**

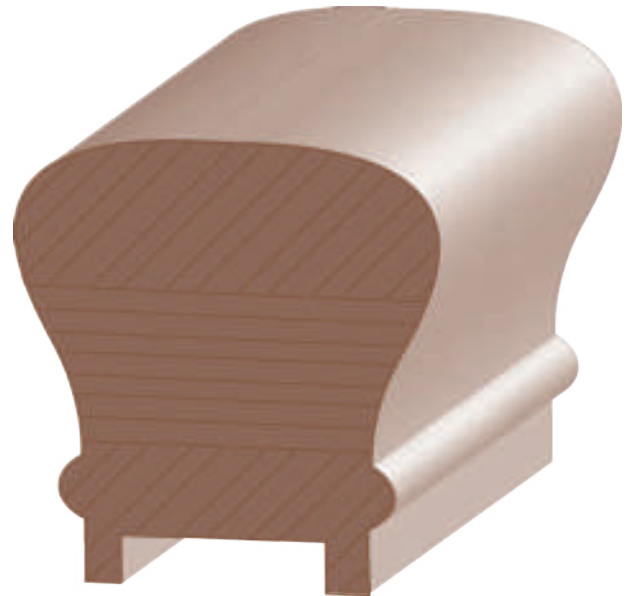

2-1/4 x 2-3/8 **Classic #6010 Handrail**
w/ 1/4" x 1-1/4" Plow (3pc Glue Up)
931PPL Poplar **S**

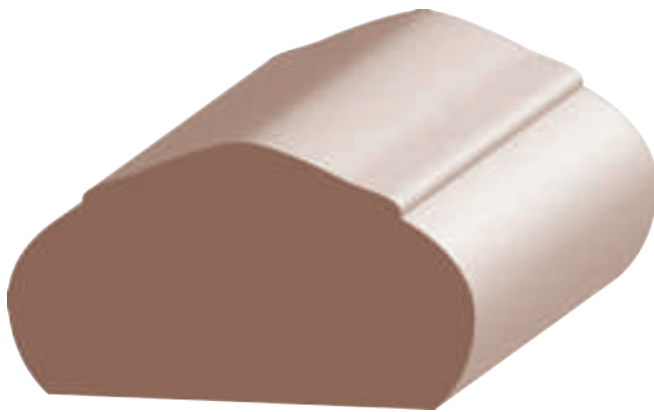

1-3/8 x 2-3/8 **"B" Mushroom Handrail**
928-0 Oak **S**

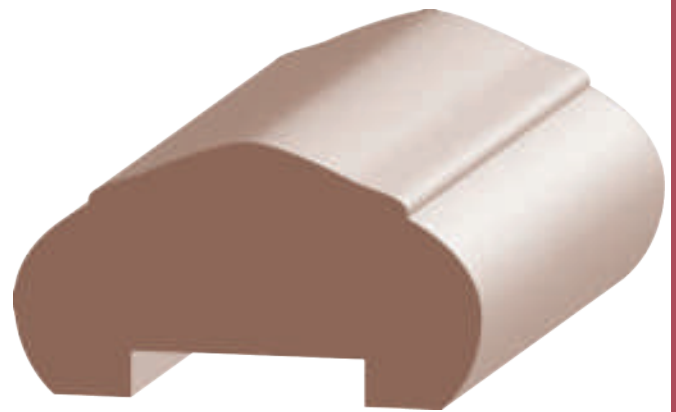

1-3/8 x 2-3/8 **"B" Mushroom Handrail**
w/ 1/4" x 1-1/4" Plow
928-0PL Oak **S**



Handrail

lengths available: 6' thru 16'

(items are approximate scale only)

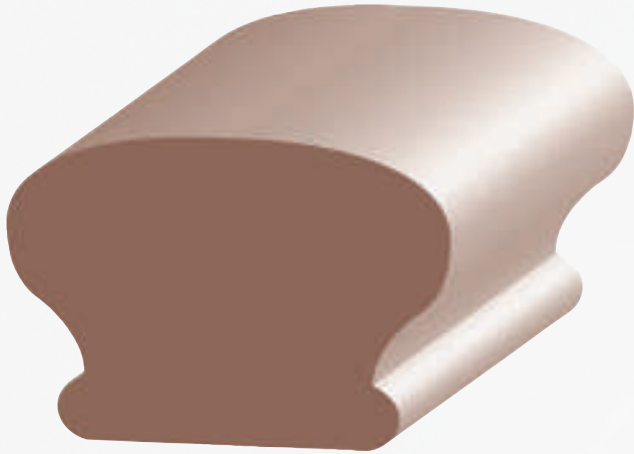

1-5/8 x 2-3/8 **Mushroom Handrail**
956-0 Oak **N**

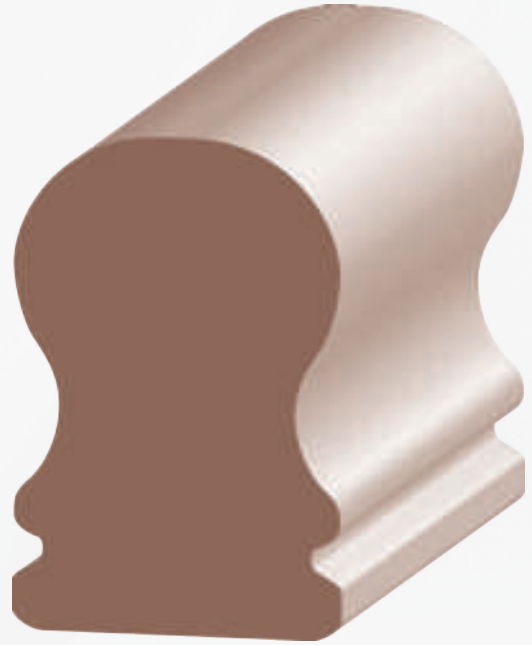

1-3/4 x 2-5/8 **Majestic Handrail**
933P Poplar **S**

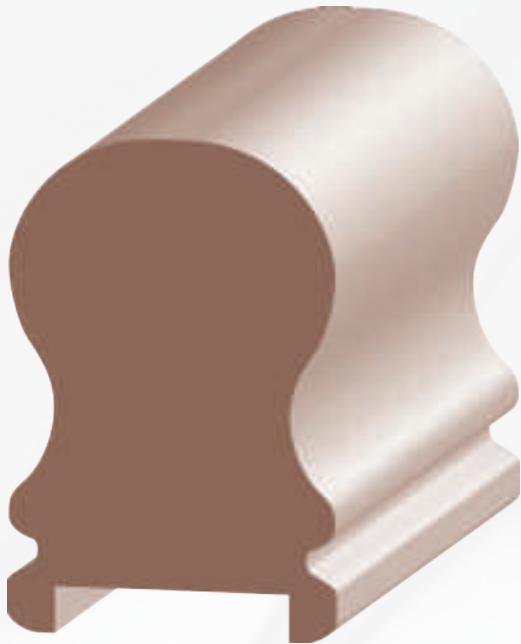

1-3/4 x 2-5/8 **Majestic Handrail**
w/ 1/4" x 1-1/4" Plow
933PPL Poplar **S**



Oak Threshold

lengths available: 3' thru 12'

(items are approximate scale only)



5/8 x 3-1/2 Threshold
850-0 Oak Lineal **S**
850-03 Oak 37" Piece **S**



3/4 x 3-1/2 Threshold
851-0 Oak Lineal **S**
851-03 Oak 37" Piece **S**



1 x 3-1/2 Threshold
854-0 Oak Lineal **S**
854-03 Oak 37" Piece **S**



3/4 x 4-1/2 Threshold
853-0 Oak Lineal **S**
853-03 Oak 37" Piece **S**



3/4 x 5-1/2 Threshold
852-0 Oak Lineal **S**
852-03 Oak 37" Piece **S**



3/4 x 3-5/8 Threshold
860-0 Oak **N**



3/4 x 4-5/8 Threshold
858-0 Oak **N**

1-1/16 x 5-5/8 Threshold
859-0 Oak **N**

Sill

(items are approximate scale only)

lengths available: 3' thru 12'



1-1/16 x 5-1/4 **Door Sill** N

1-1/16 x 7-1/4 **Door Sill** N

50S Oak	5CS Cherry	5MHS Mahogany	5ALDS Superior Alder	5WLS Walnut
70S Oak	7CS Cherry	7MHS Mahogany	7ALDS Superior Alder	7WLS Walnut



Beveled Sill

80S 1-1/4 x 7-1/8 Oak S

100S 1-1/4 x 8-7/8 Oak S

120S 1-1/4 x 11-1/4 Oak S



Flat Oak Sill

8FOS 1-1/4 x 7-1/4 Oak S

10FOS 1-1/4 x 8-7/8 Oak S

12FOS 1-1/4 x 11-1/4 Oak S



(items are approximate scale only)

Nose & Cove

lengths available: 6' through 16'

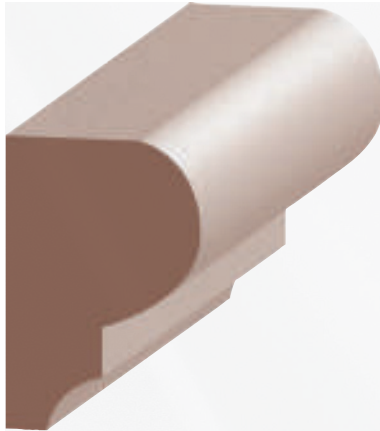

1 x 1-5/8 **Nose & Cove**
909P Poplar **N/S**
909-0 Oak **N/S**
909ALD Superior Alder **N/S**

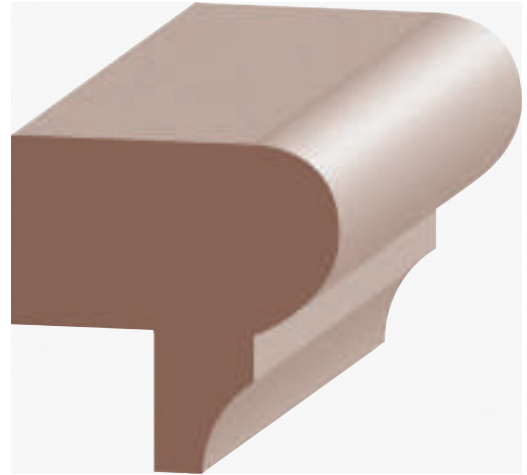

1-3/4 x 1-3/4 **Rab't Nose & Cove** [with 3/4" Rab't]
910P Poplar **N/S**
910-0 Oak **N/S**

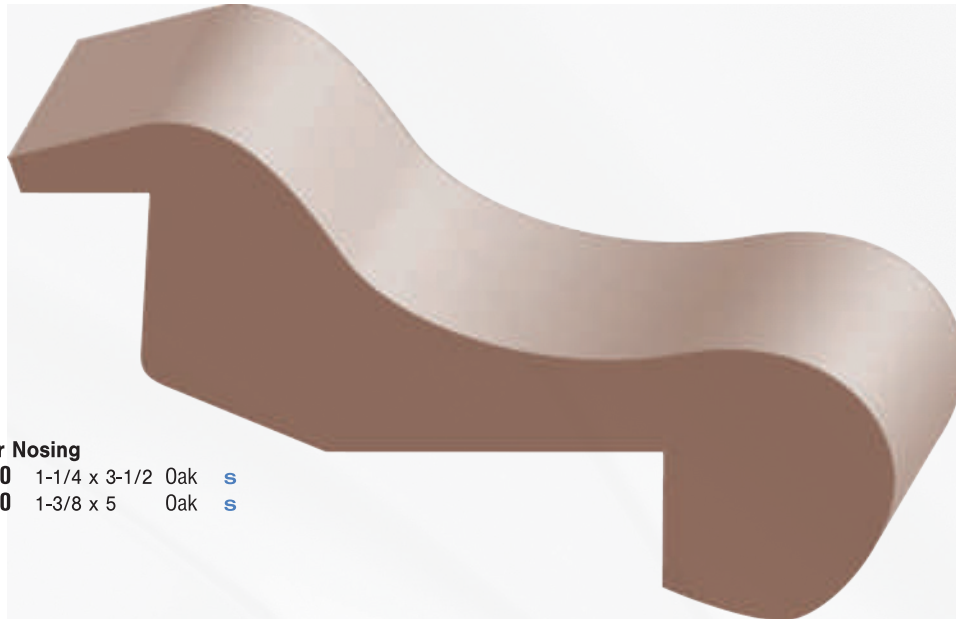

Bar Nosing
49-0 1-1/4 x 3-1/2 Oak **S**
50-0 1-3/8 x 5 Oak **S**

Stair Nosing

lengths available: 6' thru 16'

(items are approximate scale only)



1-1/16 x 3-1/2 **Nosing**
[with 1/4" x 2-1/8" Rab't]
912-0 Oak **N**

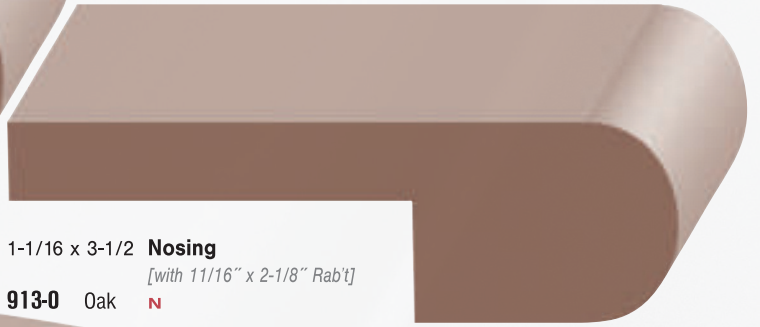

1-1/16 x 3-1/2 **Nosing**
[with 11/16" x 2-1/8" Rab't]
913-0 Oak **N**



1-1/16 x 4-1/2 **Lintel Mold**
998P Poplar **S**



7/16 x 1-1/8 **Window Stool**
995P Poplar **N/S**



1/2 x 1-7/16 **Rab't Stool**
[with 1/8" x 1" Rab't]
997P Poplar **N/S**



1-1/16 x 2 **Window Stool**
996P Poplar **N/S**

Stool

lengths available: 6' thru 16'



Ogee Stool
992P 11/16 x 5-7/16 Poplar **N** | **992-0** 11/16 x 5-1/4 Oak **N**
994P 11/16 x 7-1/4 Poplar **N** | **994-0** 11/16 x 7-1/4 Oak **N**

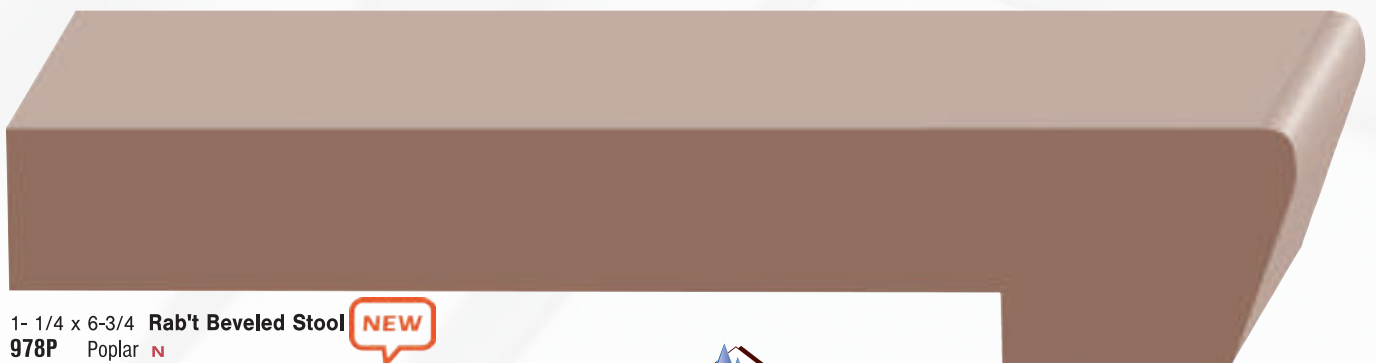

1- 1/4 x 6-3/4 **Rab't Beveled Stool** **NEW**
978P Poplar **N**



(items are approximate scale only)

Reducer



5/8 x 2 Reducer
892-0 Oak **S**
892C Cherry **S**
892MP Maple **S**



11/16 x 2 Variable Reducer
893-0 Oak **S**
893C Cherry **S**
893MP Maple **S**



1/2 x 2 Reducer
894-0 Oak **S**
894C Cherry **S**
894MP Maple **S**



S4S Boards



3/4 x 2-1/4 Reducer
899-0 Oak **S**
899C Cherry **S**
899MP Maple **S**

Poplar

713P	3/4 x 1-5/8	(1x2)	N/S
714P	3/4 x 2-1/2	(1x3)	N/S
715P	3/4 x 3-1/2	(1x4)	N/S
750P	3/4 x 5-1/2	(1x6)	N/S
751P	3/4 x 7-1/4	(1x8)	N/S
752P	3/4 x 9-1/4	(1x10)	N/S
753P	3/4 x 11-1/4	(1x12)	N/S

Oak

713-0	3/4 x 1-5/8	(1x2)	N/S
714-0	3/4 x 2-1/2	(1x3)	N/S
715-0	3/4 x 3-1/2	(1x4)	N/S
750-0	3/4 x 5-1/2	(1x6)	N/S
751-0	3/4 x 7-1/4	(1x8)	N/S
752-0	3/4 x 9-1/4	(1x10)	S
753-0	3/4 x 11-1/4	(1x12)	N/S

Superior Alder

715ALD	3/4 x 3-1/2	(1x4)	N/S
750ALD	3/4 x 5-1/2	(1x6)	N/S
751ALD	3/4 x 7-1/4	(1x8)	N/S
752ALD	3/4 x 9-1/4	(1x10)	S

Cherry

714C	3/4 x 2-1/2	(1x3)	N
715C	3/4 x 3-1/2	(1x4)	N/S
750C	3/4 x 5-1/2	(1x6)	N/S
751C	3/4 x 7-1/4	(1x8)	N/S
752C	3/4 x 9-1/4	(1x10)	N/S
753C	3/4 x 11-1/4	(1x12)	N

Maple

714MP	3/4 x 2-1/2	(1x3)	N
715MP	3/4 x 3-1/2	(1x4)	N/S
750MP	3/4 x 5-1/2	(1x6)	N/S
751MP	3/4 x 7-1/4	(1x8)	N/S
752MP	3/4 x 9-1/4	(1x10)	S
753MP	3/4 x 11-1/4	(1x12)	N

Mahogany

713MH	3/4 x 1-5/8	(1x2)	N
714MH	3/4 x 2-1/2	(1x3)	N
715MH	3/4 x 3-1/2	(1x4)	N/S
750MH	3/4 x 5-1/2	(1x6)	N/S
751MH	3/4 x 7-1/4	(1x8)	N/S
752MH	3/4 x 9-1/4	(1x10)	S
753MH	3/4 x 11-1/4	(1x12)	N/S

Knotty Alder 2E2

715KA	3/4 x 3-1/2	(1x4)	N
750KA	3/4 x 5-1/2	(1x6)	N
754KA	1 x 5-1/2	(1x6)	N
756KA	1-1/2 x 5-1/2	(2x6)	N
751KA	3/4 x 7-1/4	(1x8)	N
753KA	3/4 x 11-1/4	(1x12)	N

Ropes

lengths available: 8'



Poplar Half Round

HR617P	3/8"	S
HR618P	1/2"	N/S
HR619P	11/16"	N/S
HR620P	1"	N/S
HR621P	1-3/16"	S
HR622P	1-3/8"	S
HR623P	1-1/2"	S
HR624P	1-3/4"	S

Oak Half Round

HR617-0	3/8"	S
HR618-0	1/2"	N/S
HR619-0	3/4"	N/S
HR620-0	1"	N/S
HR621-0	1-3/16"	S
HR622-0	1-3/8"	S
HR623-0	1-1/2"	S
HR624-0	1-3/4"	S

Sup. Alder Half Round

HR618ALD	1/2"	N/S
HR619ALD	3/4"	N/S
HR620ALD	1"	N/S
HR621ALD	1-3/16"	S
HR622ALD	1-3/8"	S
HR623ALD	1-1/2"	S
HR624ALD	1-3/4"	S

Cherry Half Round

HR617C	3/8"	S
HR618C	1/2"	N/S
HR619C	11/16"	N/S
HR620C	1"	N/S
HR621C	1-3/16"	S
HR622C	1-3/8"	S
HR623C	1-1/2"	S
HR624C	1-3/4"	S

Maple Half Round

HR618MP	1/2"	N/S
HR619MP	11/16"	N/S
HR620MP	1"	N/S
HR621MP	1-3/16"	S
HR622MP	1-3/8"	S
HR623MP	1-1/2"	S
HR624MP	1-3/4"	S

Poplar Full Round

FR626P	1-3/8"	S
FR627P	1-3/4"	S

Oak Full Round

FR626-0	1-3/8"	S
FR627-0	1-3/4"	S

Cherry Full Round

FR626C	1-3/8"	S
FR627C	1-3/4"	S



3/4" Exterior Door Frames

(items are approximate scale only)

lengths available: 6' thru 16'

Door Frame Specs

- ☑ 1-1/4" Thick **N**
- ☑ 6/8 = 82-1/2" Below Dado
- ☑ 8/0 = 98-1/2" Below Dado
- ☑ No Screen Rabbet
- ☑ Single End Dado (Except on Lineal)
- ☑ 3 Pair Per Bundle
- ☑ Kerfing for Bullnose is Available
- ☑ Custom Widths Available

FOR 1-3/4" DOORS



Standard = No 'W' in Part #



Weatherstrip Kerfed = 'W' in Part # **Qlon Sold Separately**

EXTERIOR DOOR FRAMES

Standard 1-13/16" Door Rab't.

Weatherstrip Kerfed with 1/2" x 2-1/8" Door Rab't.

SIZE	Oak			Superior Alder		Knotty Alder		Poplar			Mahogany			Cherry			
	6/8	8/0	RNDM. LINEAL	6/8	8/0	6/8	8/0	6/8	8/0	RNDM. LINEAL	6/8	8/0	RNDM. LINEAL	6/8	8/0	RNDM. LINEAL	
4-1/8	41806	41808	4180L	N/A	N/A	N/A	N/A	418P6	418P8	418PL	418M6	418M8	418ML	418C6	418C8	418CL	N/S
	418W06	418W08	418W0L	N/A	N/A	N/A	N/A	418WP6	418WP8	418WPL	418WM6	418WM8	418WML	418WC6	418WC8	418WCL	N/S
4-1/2	41206	41208	4120L	N/A	N/A	N/A	N/A	N/A	N/A	N/A	N/A	N/A	N/A	N/A	N/A	N/A	S
	N/A	N/A	412W0L	N/A	N/A	N/A	N/A	N/A	N/A	N/A	N/A	N/A	N/A	N/A	N/A	N/A	S
4-5/8	45806 N	45808 N	4580L N	458SA6	458SA8	458KA6	458KA8	458P6 N	458P8 N	458PL N	458M6 N	458M8 N	458ML N	458C6	458C8	458CL	N/S
	458W06	458W08	458W0L	458WSA6	458WSA8	458WKA6	458WKA8	458WP6 N	458WP8 N	458WPL N	458WM6 N	458WM8 N	458WML N	458WC6	458WC8	458WCL	N/S
5-1/4	5140E6	5140E8	5140EL	514SAE6	514SAE8	514KAE6	514KAE8	514PE6	514PE8	514PEL	514ME6	514ME8	514MEL	514CE6	514CE8	514CEL	N/S
	514W06	514W08	514W0L	514WSA6	514WSA8	514WKA6	514WKA8	514WP6	514WP8	514WPL	514WM6	514WM8	514WML	514WC6	514WC8	514WCL	N/S
6-5/8	N/A	N/A	N/A	N/A	N/A	N/A	N/A	N/A	N/A	N/A	N/A	N/A	N/A	658C6	658C8	N/A	N/S
	N/A	N/A	N/A	N/A	N/A	N/A	N/A	N/A	N/A	N/A	N/A	N/A	N/A	658WC6	658WC8	N/A	N/S
7-1/4	7140E6	7140E8	7140EL	714SAE6	714SAE8	714KAE6	714KAE8	714PE6	714PE8	714PEL	714ME6	714ME8	714MEL	714CE6	714CE8	714CEL	N/S
	714W06	714W08	714W0L	714WSA6	714WSA8	714WKA6	714WKA8	714WP6	714WP8	714WPL	714WM6	714WM8	714WML	714WC6	714WC8	714WCL	N/S
9-1/4	N/A	N/A	N/A	N/A	N/A	914WKA6	914WKA8	N/A	N/A	N/A	N/A	N/A	N/A	N/A	N/A	N/A	N/S

Interior Door Jamb Specs

(NOR CAL, CENTRAL CAL, AZ) / (SO CAL, NV)

- ☑ 1 1/16" Thick
- ☑ 6/8 = 81" Below Dado **N/CC/AZ**
- ☑ 8/0 = 97" Below Dado **N/CC/AZ**
- ☑ 6/8 = 80-5/8" Below Dado **S/NV**
- ☑ 8/0 = 96-5/8" Below Dado **S/NV**
- ☑ Lineal - Available in random lengths. Check for specific length availability
- ☑ Random Lengths only available in most Solid Wood Species
- ☑ Dado depth is 3/8"
- ☑ Heads cut 3/4 over opening
- ☑ 5 pair per bundle

Interior Jambs

lengths available: 6' & 16'



Kerfing for bullnose is available on all jamb sizes and species.
Custom size odd wall widths available upon request.

INTERIOR DOOR JAMBS

SIZE	Red Oak			Superior Alder			Knotty Alder			Poplar			Mahogany	Cherry			
	6/8	8/0	RNDM. LINEAL	6/8	8/0	RNDM. LINEAL	6/8	8/0	RNDM. LINEAL	6/8	8/0	RNDM. LINEAL	8/0	6/8	8/0	RNDM. LINEAL	
3-9/16	N/A	N/A	N/A	3916ALDI6	3916ALDI8	3916ALDIL	3916KAI6	3916KAI8	3916KAIL	N/A	N/A	N/A	N/A	3916CI6 N	3916CI8 N	N/A	N/S
4-9/16	49160I6	49160I8	49160IL	4916ALDI6	4916ALDI8	4916ALDIL	4916KAI6	4916KAI8	4916KAIL	4916PI6	4916PI8	4916PIL	N/A	4916CI6	4916CI8	4916CIL	N/S
4-5/8	N/A	N/A	N/A	458ALDI6	458ALDI8	458ALDIL	N/A	N/A	N/A	N/A	N/A	N/A	N/A	N/A	N/A	N/A	S
4-7/8	N/A	N/A	N/A	478ALDI6	478ALDI8	478ALDIL	N/A	N/A	N/A	N/A	N/A	N/A	N/A	N/A	N/A	N/A	S
4-13/16	4340I6	4340I8	4340IL	434ALDI6	434ALDI8	434ALDIL	434KAI6	434KAI8	434KAIL	434PI6	434PI8	434PIL	434MH18 S	434CI6	434CI8	434CIL	N/S
5-1/4	5140I6	5140I8	5140IL	514ALDI6	514ALDI8	514ALDIL	514KAI6	514KAI8	514KAIL	514PI6	514PI8	514PIL	514MH18 S	514CI6	514CI8	514CIL	N/S
7-1/4	7140I6	7140I8	7140IL	714ALDI6	714ALDI8	714ALDIL	714KAI6	714KAI8	714KAIL	714PI6	714PI8	714PIL	714MH18 S	714CI6	714CI8	714CIL	N/S
9-1/4	N/A	N/A	N/A	N/A	N/A	N/A	914KAI6	914KAI8	914KAIL	N/A	N/A	N/A	N/A	N/A	N/A	N/A	N/S
11-1/4	11140I6	11140I6	11140I6	N/A	N/A	N/A	N/A	N/A	N/A	1114PI6	1114PI8	1114PIL	N/A	N/A	N/A	N/A	S





©2018. All White River products are copyrighted and proprietary and cannot be duplicated without express permission.

White River Embossed and **Mon Reale** high clay relief mouldings add elegance with ornamental detail, historically found throughout the world. Millwork, cabinetry, mirrors, mantels and more are instantly transformed into a style reflecting master craftsmanship. Embossed mouldings are created by pressing a pattern into the wood and altering the wood fibers. High Relief (Mon Reale) millwork is created using a clay overlay on poplar wood with a wheel that presses a design into the clay. The result is beautiful, sharp details that resemble the details of plaster ornamentation, only in wood that's easy to install.

Most White River™ products are stocked in our Southern California facility and are transferred to Northern California. Please allow 2-3 days for delivery in NorCal and next-day delivery in SoCal. For White River's full line of products, please refer to whiteriver.com. Special orders and Flex may take 2-3 weeks for delivery.



section contents

EMBOSSSED

Backbands.....	333
Base	333
Casing.....	333
Chair Rail.....	333
Cornice (Crown).....	334
Panel Mold	335
Lineal Moulding.....	336

MON REALE

Backbands.....	338
Casing.....	338
Cornice Mouldings	339
Frieze Mouldings.....	340
Panel Mold	341
Staining and Installation.....	344

White River™

UNSURPASSED DEFINITION, STAINABILITY AND AFFORDABILITY



©2018. All White River products are copyrighted and proprietary and cannot be duplicated without express permission.

White River™ Embossed and Mon Reale High Relief mouldings give profiles a beautifully subtle ornamental look beyond standard mouldings.

Express a different look or feel in any room or your entire home with White River™ products from EL & EL. Mouldings have long been recognized for the beauty and elegance they can create. Embossed and Mon Reale mouldings create a customized and unique look for any home, enhancing bookshelves, cabinetry and mirrors, far beyond common moulding applications.

Products can be used alone or combined together to create larger scale details and install with standard woodworking tools. Profiles ship unfinished and can be stained or painted.

Whether you are working on a residential remodel, new construction or restoration project there's a design solution that will finish it off with style.



random lengths standard 3'-16'

large selection of styles in stock

custom milling available



(items are approximate scale only)

Embossed Poplar Casing, Backbands & Base

lengths available: mixed length bundles 3' thru 16'

Ornamentally Embossed™ is a proprietary trademark of White River™ Hardwoods-Woodworks, Inc.® including: crowns, cases, baseboards, chairrails and panel moulds.

BASE I



BA42 3/4" x 7" **Rope Base**



BA43C 3/4" x 5-1/2"
Egg & Dart w/Bead & Barrel Base



BA44 3/4" x 6" **Rope Base**



BA46 11/16" x 5-1/2" **Bead & Barrel Base**



BA47 3/4" x 5-1/2" **Leaf & Reed Base**



BA48 11/16" x 5-1/2" **Running Coin Base**

BACKBANDS I Backbands lip casings to add depth, width, & detail.



BB15 1-1/2" x 1-3/8" lips 13/16"
Roman Coin Back Band



BB17 1-3/4" x 2-1/2" lips 13/16"
Egg & Dart w/Bead & Barrel Back Band

CHAIR RAILS I



CR61 13/16" x 2-1/2"
Fluting Chair Rail



CR63A 1-1/16" x 3-1/4"
Running Coin w/Bead & Barrel Chair Rail



CR64 1-1/16" x 3"
Laurel Leaf w/Bead & Barrel Chair Rail



CR65 13/16" x 2-1/2"
Egg & Dart Chair Rail



CR66 1" x 3-1/2" *pattern repeats 7-1/2"*
Reed & Ribbon Chair Rail



CR67 13/16" x 2-1/8"
Dentil Chair Rail



CR68 1-3/4" x 2-1/2" lips 13/16"
Rab't Rope Chair Rail



CR69 1-1/16" x 2 1/4"
Dentil w/Rope Chair Rail



CR70 3/4" x 3"
Fluting Chair Rail



CR72 3/4" x 3"
Running Leaf Chair Rail

CASING I

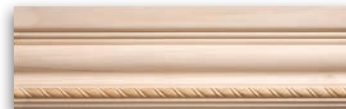

CA30 13/16" x 3-3/4"
Rope Casing



CA31 13/16" x 4"
Acanthus Leaf w/Bead & Barrel Casing



CA36 13/16" x 3-1/4"
Bead & Barrel Casing



CA37 1-1/16" x 4"
Lamb's Tongue w/Rope Casing



CA38 1-1/4" x 4"
Egg & Dart w/Rope Casing



CA39 13/16" x 3-1/2"
Egg & Dart w/Bead & Barrel Casing



CA40 1-1/4" x 4"
CA41 13/16" x 3-1/4"
Leaf & Reed w/Bead Casing



DH99 1-1/16" x 5-1/4"
Bead & Barrel Decorative Header

Poplar Embossed Cornice Mouldings

lengths available: mixed length bundles 3" thru 16"

(items are approximate scale only)



CM69 3/4" x 2-3/4"
Egg & Dart with Rope Cornice



CM81 1-1/16" x 4-3/4"
Lamb's Tongue Cornice



CM88 3/4" x 2-3/4"
Rope Cornice



CM70 13/16" x 4-3/8"
Fluted Cornice



CM82 1-1/16" x 5-7/8"
Coin with Rope & Tongue Cornice



CM89 3/4" x 2-3/4"
Egg & Dart Cornice



CM71 13/16" x 4-1/2"
Egg & Dart with Lamb's Tongue Cornice



CM83 13/16" x 5-1/2"
Egg & Dart with Lamb's Tongue Cornice



CM90 3/4" x 5-1/2"
Leaf & Reed with Bead Crown



CM72 13/16" x 3-3/4"
Egg & Dart Cornice



CM84 13/16" x 6-1/4"
Bead with Lamb's Tongue Cornice



CM93 13/16" x 5-1/2"
Fluting & Coins Cornice



CM75 13/16" x 5-3/16"
Bead with Dentil Cornice



CM85 13/16" x 3-3/4"
Bead Cornice



CM94 13/16" x 5-1/2"
Running Leaf & Coins Crown



CM76 13/16" x 5-1/2"
Acanthus Leaf with Bead & Barrel Cornice



CM86 13/16" x 7"
Dentil with Lamb's Tongue Cornice



CM95 13/16" x 3"
Fluting Crown



CM77 13/16" x 4"
Acanthus Leaf with Bead & Barrel Cornice



CM87 3/4" x 5"
Dentil with Rope Cornice



CM96 13/16" x 3"
Running Leaf Crown



CM80 13/16" x 5-1/2"
Fluting with Beads Cornice

ELandELWoodProducts.com

white river™ | poplar embossed cornice mouldings



(items are approximate scale only)

Poplar Embossed® Panel Mouldings

NOTE: Panel mouldings have a flat back unless otherwise noted.



PM07 5/8" x 1-1/8"
Laurel Leaf Panel Mold



PM08 5/8" x 1-1/4"
Vining Berries Panel Mold



PM09 5/8" x 1-1/4"
Acanthus Scrolls Panel Mold



PM10 5/8" x 1-1/4"
Egg & Dart Panel Mold



PM11 7/16" x 5/8"
Rope Panel Mold



PM12 5/8" x 1-1/8"
Running Coin Panel Mold



PM14 1/2" x 1"
Bead & Barrel Panel Mold



PM20 13/16" x 2"
Bead & Barrel w/Lamb's Tongue Panel Mold



PM22PL 11/16" x 1-3/4" lips 1/4"
Rab't Bead & Barrel Panel Mold



PM22 11/16" x 1-3/4"
Bead & Barrel Panel Mold



PM23B 3/4" x 2"
Running Coin w/Rope Panel Mold



PM24 3/4" x 2"
Bead w/Bead & Barrel Panel Mold



PM25 1" x 2-1/2"
Laurel Leaf w/Bead & Barrel Panel Mold

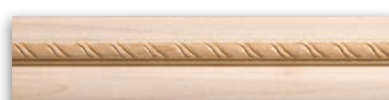

PM27 3/4" x 2"
Rope Panel Mold



PM50 3/4" x 1-1/4"
Lamb's Tongue Panel Mold



PM52 13/16" x 1-3/4"
Running Coin Panel Mold



PM54 11/16" x 1-1/2"
Rope Panel Mold



PM55 13/16" x 1-1/4"
Laurel Leaf Panel Mold

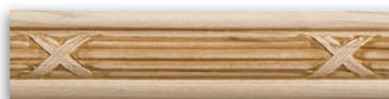

PM56B 1/2" x 7/8"
Reed & Ribbon Panel Mold



PM57 5/8" x 1-1/4"
Rope Panel Mold



PM58 5/8" x 1"
Bead & Barrel Panel Mold



PM595 5/8" x 3-1/4"
Traditional Panel Mold



PM59 5/8" x 3/4"
Bead & Barrel Panel Mold



PM70 3/4" x 2-3/8" lips 1/2" - 3/4"
Rope Panel Mold



PM71 3/4" x 1-3/4"
Leaf & Reed Panel Mold



PM72 11/16" x 1-5/8"
Egg & Dart w/Bead & Barrel Panel Mold



PM73 5/8" x 1"
Egg & Dart Panel Mold



PM74 3/8" x 1/2"
Bead & Barrel Panel Mold



PM16 3/4" x 3" MDF Running Leaf & Bead

Poplar Embossed® Lineal Mouldings

LINEAL MOULDINGS I



LM90 1-1/16" x 3-1/2" *pattern repeats 6 3/8"*
Grapevine Lineal



LM91 1-1/16" x 3-1/2"
Flute w/Leaf Lineal



LM92 1-1/16" x 3-1/2"
Greek Key Lineal



©2018. All White River products are copyrighted and proprietary and cannot be duplicated without express permission.

Mon Reale is a fine-grained overlay material contoured to traditional hardwood to create a moulding of unusual elegance. The depth of detail creates a greater degree of definition than found in our ornamentally embossed mouldings. Discriminating architects, interior designers and decorators look forward to crafting new levels of aesthetics in their most important projects for their most refined clients.

section contents

Poplar Mon Reale® Backbands	338
Poplar Mon Reale® Casing	338
Poplar Mon Reale® Cornice Mouldings..	339
Poplar Mon Reale® Frieze Mouldings....	340
Poplar Mon Reale® Panel Molds	341
Staining & Installation	344



Poplar Mon Reale® Backbands, Casing

(items are approximate scale only)



BB8108 1-3/4" x 2" lips 13/16"
Lamb's Tongue



CA8320 1-1/4" x 4-1/2"
Running Leaf & Bead Casing



CA8336 1-7/8" x 5" Repeats 8"
Bead & Barrel w/Reed & Ribbon Casing



BB8109 2" x 2-1/2" lips 13/16"
Ropes of Antiquity Backband



CA8322 1-1/16" x 4-1/2"
Large Rope Casing



CA8338 13/16" x 3-3/4"
Small Bead Casing



BB8110 1-13/16" x 1-1/2" lips 13/16"
Coin Backband
Repeats 1"



CA8326 1-1/4" x 4-1/2" Repeats 4-3/4"
Reed & Ribbon Casing



CA8340 1-1/16" x 3-3/4"
Running Leaf & Bead Casing



BB8111 1-3/4" x 2-1/2" lips 13/16"
Petite Acanthus Leaf Backband
Repeats 2-7/8"



CA8330 1-7/8" x 5" Repeats 8"
Large Bead w/Laurel Leaf & Ribbon Casing



CA8342 13/16" x 3-3/4"
Rope Casing



BB8122 1-13/16" x 2" lips 13/16"
Running Leaf & Pearl Backband
Repeats 2-1/4"



Backbands Lip 13/16" Casings
Drawing shows BB8120 with CA364



CA8344
13/16" x 4"



CA8344 13/16" x 4"
Lamb's Tongue & Bead Casing



BA8440 3/4" x 6-1/2"
Running Leaf Base Repeats 2-1/4"

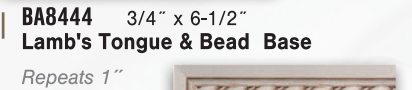

BA8444 3/4" x 6-1/2"
Lamb's Tongue & Bead Base
Repeats 1"



CA8347 1-3/8" x 4"
Egg & Dart w/Lamb's Tongue Casing



BA8442 3/4" x 6"
Rope Base Repeats 1-1/4"



CA8348 1-3/8" x 4"
Running Leaf w/Lamb's Tongue Casing

(items are approximate scale only)

Poplar Mon Reale® Cornice Mouldings

lengths available: mixed length bundles 3' thru 16'



CM8780 1-1/16" x 8-1/2"
Acanthus Leaf & Coin Crown



CM8782 13/16" x 5-1/2"
Acanthus Leaf Crown



CM8783 3/4" x 2-3/4"
Small Acanthus Leaf Crown



CM8801 7/8" x 6"
Large Acanthus Leaf Crown
Pattern Repeats 7"



CM8808 7/8" x 7-1/2"
Acanthus w/Egg & Dart & Dentil Crown
Pattern Repeats 7-1/2"



CM8810 15/16" x 4-3/4"
Medium Acanthus Leaf Crown
Pattern Repeats 4-3/4"



CM8812 1" x 6"
Medium Acanthus Leaf w/Egg & Dart Crown



CM8820 13/16" x 2-3/4"
Petite Acanthus Leaf Crown
Pattern Repeats 2-7/8"



CM8823 1" x 3-3/4"
Egg & Dart Crown
Pattern Repeats 3"



CM8825 1" x 7-1/2"
Egg & Dart w/Running Leaf Crown



CM8830 7/8" x 6"
Flute & Leaf w/Beads Crown
Pattern Repeats 13-1/2"



CM8834 3/4" x 4"
Large Rope Crown



CM8837 7/8" x 7"
Petite Acanthus Leaf Egg & Dart Crown



CM8840 7/8" x 7-1/2"
Egg & Dart with Dentil Crown



CM8853 1-1/16" x 8-1/2"
X-Large Acanthus Leaf Crown



CM8854 1-1/16" x 7-1/2"
Acanthus Leaf with Beads Crown



CM8856 13/16" x 6-1/2"
Lamb's Tongue with Bead Crown

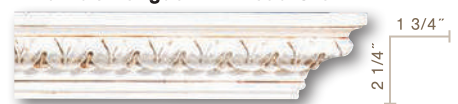

CM8857 3/4" x 2-3/4"
Lamb's Tongue Crown
Pattern Repeats 1-3/8"



CM8858 13/16" x 7"
Egg & Dart with Bead & Dentil Crown



CM8859 13/16" x 4"
Egg & Dart with Lamb's Tongue Crown



CM8860 3/4" x 3"
Lamb's Tongue Crown



CM8862 13/16" x 5"
Egg & Dart Crown



Poplar Mon Reale® Frieze Mouldings

(items are approximate scale only)

Mon Reale® is a registered trademark of White River™ Hardwoods-Woodworks, Inc.® and includes: crowns, cases, bases, friezes and panel moulds.



FR8920 13/16" x 3-3/4"
Fluting Frieze
Repeats 7/8" - MT = 3/4"



FR8950 13/16" x 5-1/2"
Country Flowers Frieze
Repeats 26" - MT = 1-1/16"



FR8957 13/16" x 5-1/2"
Ribbon & Bow Swag Frieze
Repeats 8" - MT = 15/16"



FR8921 13/16" x 3-3/4"
Leafy Scroll Frieze
Repeats 6-1/8" - MT = 1"



FR8953 13/16" x 5-1/2"
Eternal Laurel Leaves
Repeats 7-1/2" - MT = 1-1/8"



FR8958 13/16" x 5-1/2"
Palmetto & Lotus Frieze
Repeats 5" - MT = 13/16"



FR8922 13/16" x 3-3/4"
Running Coin Frieze
Repeats 2" - MT = 1"



FR8954 13/16" x 5-1/2"
Vitruvian Wave Frieze
Repeats 3-1/2" - MT = 7/8"



FR8960 13/16" x 5-1/2"
Shell & Fret Frieze
Repeats 16" - MT = 1"



FR8923 13/16" x 3-3/4"
Greek Keys w/Rosettes Frieze
Repeats 19" - MT = 7/8"



FR8955 13/16" x 5-1/2"
Griffins & Urns Frieze
Repeats 26-1/2" - MT = 7/8"



FR8965 13/16" x 5-1/2"
Rinceau Scrolls Frieze
Repeats 11-1/2" - MT = 7/8"



FR8940 13/16" x 3-3/4"
Roses & Butterflies Frieze
Repeats 12-1/2" - MT = 7/8"



FR8956 13/16" x 5-1/2"
Grapevine & Tassel Frieze
Repeats 24" - MT = 1"



FR8967 13/16" x 6-3/4"
Large Scrolled Palmette Frieze

(items are approximate scale only)

Poplar Mon Reale® Panel Mold



PM8511 13/16 x 2 **Running Leaf** [Pattern Repeats 2-1/4"]



PM8520 7/8 x 2 **Running Coin** [Pattern Repeats 1"]



PM8522 9/16 x 1 **Small Beads** [Pattern Repeats 1/4"]



PM8523 7/8 x 1-3/4 **Large Beads** [Pattern Repeats 1/2"]



PM8524 5/8 x 1 **Small Beads** [Pattern Repeats 1/4"]



PM8525 7/8 x 1-1/2 **Large Beads** [Pattern Repeats 1/2"]



PM8526 9/16 x 1 **Small Bead & Barrel** [Pattern Repeats 2-3/8"]



PM8527 7/8 x 1-3/4 **Large Bead & Barrel** [Pattern Repeats 5"]



PM8528 5/8 x 1 **Bead & Barrel** [Pattern Repeats 2-3/8"]



PM8529 7/8 x 1-1/2 **Large Bead & Barrel** [Pattern Repeats 5"]



PM8532 1-1/8 x 2-3/4 **Large Laurel Leaf & Ribbon**
[Pattern Repeats 8"]



PM8535 3/4 x 1-1/2 **Small Egg & Dart** [Pattern Repeats 1-3/4"]

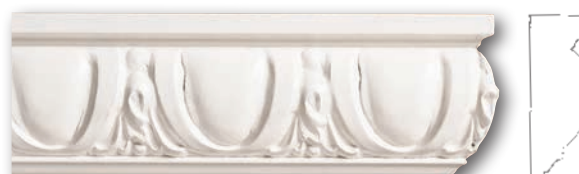

PM8536 1 x 2-3/4 **Large Egg & Dart** [Pattern Repeats 2-5/8"]



PM8538 13/16 x 1-1/2 **Egg & Dart**



PM8540 5/8 x 1 **Small Rope** [Pattern Repeats 3/4"]



PM8541 7/8 x 1-1/2 **Large Rope** [Pattern Repeats 1-1/4"]



PM8545 9/16 x 1 **Small Rope** [Pattern Repeats 3/4"]



PM8546 7/8 x 1-3/4 **Large Rope** [Pattern Repeats 1-1/4"]

Poplar Mon Reale® Panel Mold

(items are approximate scale only)



PM8552 13/16 x 2 **Reed & Ribbon** [Pattern Repeats 4-3/4"]



PM8564 7/8 x 2 **Medium Lamb's Tongue**



PM8553 1-1/8 x 2-3/4 **Reed & Ribbon** [Pattern Repeats 8"]



PM8565 9/16 x 1 **Small Lamb's Tongue**



PM8555 1-3/8 x 5-1/2 **Acanthus w/Pearl** [Pattern Repeats 4-1/2"]



PM8568 13/16 x 2-1/2 **Running Leaf with Beads**
[Lips 1/2" - 13/16"]



PM8569 13/16 x 2-1/2 **Ribbon & Reed** [Lips 1/2" - 13/16"]



PM8557 1-1/4 x 2-1/2 **Large Rope w/Pearls**



PM8571 1 x 3 **Egg & Dart** [Lips 1/8" - 13/16"]



PM8558 7/8 x 1-3/4 **Medium Rope w/Pearls**



PM8572 1-1/2 x 3-1/2 **Large Rope w/Pearls**
[Pattern Repeats 1-3/4"]



PM8560 7/8 x 2 **Medium Acanthus**



PM8573 13/16 x 2-1/2 **Small Acanthus Leaf**



PM8561 1/2 x 1 **Small Acanthus** [Lips 1/2" - 13/16"]

(items are approximate scale only)

Poplar Mon Reale® Frieze Mouldings



FR8968 13/16" x 6-3/4"
Flutes with Bellflowers Frieze Repeats 2-3/8" - MT = 13/16"



FR8970 3/4" x 8"
Classical Doric Frieze Repeats 7-3/4" - MT = 1"



FR8971 13/16" x 6-3/4"
Acanthus Leaf & Tongue Frieze Repeats 2-5/8" - MT = 1"



FR8980 1-1/16" x 6"
Large Acanthus Leaf & Scrolled Bellflowers



FR8982 1" x 4-1/2"
Medium Acanthus Leaf & Scrolled Bellflowers

4

Exciting New MDF Mouldings

- Collection features versatile Crowns, Friezes, and Panel Moulds
- Produced from Primed Pactrim domestic lightweight MDF
- Available in 16' lengths, unfinished
- New – Exciting ornamental designs
- Gorgeous high relief mouldings and a great value!

Beautiful Ornamentation Applied to 16' MDF
Here are our most popular designs and their dimensions for interior applications. Fine grain overlay contoured to a traditional primed MDF moulding, that you can stain, paint, or glaze.



CR13 Acanthus and Running Coin Crown
7/8" x 7" - pattern repeats 4-1/8"



CR14 Acanthus Crown
7/8" x 5-1/2" - pattern repeats 3-1/4"



FR15 Rinceau Scrolls Frieze
3/4" x 5" - pattern repeats 8-3/8"



FR16 Running Leaf and Bead Panel Mould
3/4" x 3" - pattern repeats 2-1/2"

Staining & Installation

(items are approximate scale only)

Steps to Staining Mouldings

ORIGINAL



Sand mouldings as you receive them.

STEP ONE



Apply one coat of latex primer.

STEP TWO



Brush thinned-out base stain evenly.

STEP THREE



Apply a stain glaze, wiping face lightly.

Notes on Staining

- Regular stain glazes are easier to work and have a softer effect.
- Heavy-bodied stain glazes are harder to work, but leave more color and intensity.
- Old Master™ and Mohawk™ are recognized brands that offer Gel Glazing stains.
- Always test finishes on a sample - White River does not warrant jobsite finishing.
- Depending on your finishing skills, spraying application with lacquer and glazing stains offer the same look!

INSTALLATION OF MOULDINGS WITH ORNAMENTAL MOTIFS |

- Installation of Door Casings: Cut head casings first so that ornamented pattern on side casing will miter into head casing. Center pattern so it miters evenly at both corners.
- Installation of Window Casings: Follow door casings, but install a window stool to add beauty and to avoid having to match four ornamented mitered corners (matching four mitered corners is easy if ornamentation is a delicate pattern).
- Installation of Crowns, Bases, and Chair rails: Install any outside corners first and work back into inside corners. If a single moulding has two motifs, match the largest motif first. If a moulding has dentil and embossing, match the dentil first and let the other motif match as well as possible. With Mon Reale and multiple motifs, you may have to make several "adjusting cuts" to find the best pattern match.

WELL-PROPORTIONED MOULDING DESIGNS |

Contrary to a misconception that large-scale mouldings make a room seem small, the opposite is true. Properly-proportioned mouldings enhance room scale and proportion by creating a sense of loftiness. In a room with 8' - 9' walls, large crowns appear to support and define the ceiling, thus increasing the feeling of height. Tall baseboards, wide casings, and ornate chair rails afford eye-catching architectural elements, fostering a comfortable and inviting environment.

CONCERNING OUR FRIEZES |

- MT indicates "Maximum Thickness" of moulding where overlay may be thicker than 13/16"
- Use backbands on page 338 with friezes to add additional width, depth, and detail.
- PM595 can be added to all friezes to provide symmetry. See panel mouldings on page 341.

RESINS |

When designing with resin, product can distort if cast to a radius that is too tight: see WhiteRiver.com for further specifications.

All curved components, whether resin or wood, take layout and thoughtful consideration for a successful installation.



Organized closets and garages are essential for today's busy lifestyle and add value to any home. To complete these projects, multiple options exist. The most widely used materials are particle board shelving and closet pole, however, wire shelving and melamine shelving are gaining popularity. With some ingenuity, you can create the same closets and garages that closet organizing companies design at a fraction of the cost.

section contents

Brackets.....	347
Chrome Pole.....	346
Cleat.....	347
Closet Lining.....	347
Edge Banding.....	347
Closet Pole.....	346
Hook.....	346
Melamine Pre-drilled Dividers.....	345
Melamine Shelving.....	345
Plastic Shelf Supports.....	347
Pole Covers.....	346
Rosettes.....	347
Shelving.....	345
Support Bracket.....	347





(items are approximate scale only)

Closet Material

Melamine Shelving			
PART#	SIZE	STOCKED LENGTH	
MS1	5/8 x 11-1/4"	8'	S
MS2	5/8 x 15-1/4"	8'	S
MS3	5/8 x 23-1/4"	8'	S
MS4	3/4 x 11-1/4"	8'	N/S
MS5	3/4 x 15-1/4"	8'	N/S
MS6	3/4 x 23-1/4"	8'	N/S

Melamine Pre-Drilled Dividers			
PART#	SIZE	STOCKED LENGTH	
MD1	5/8 x 11-1/2"	8'	S
MD2	5/8 x 15-1/2"	8'	S
MD3	5/8 x 23-1/2"	8'	S
MD4	3/4 x 11-1/2"	7'	N/S
MD5	3/4 x 15-1/2"	7'	N/S
MD6	3/4 x 23-1/2"	7'	N/S

Unprimed Particle Board Shelving			
PART#	SIZE	STOCKED LENGTH	
11PB-BN	3/4 x 11-1/4" Bullnose	12', 16'	N
16PB-BN	3/4 x 15-1/4" Bullnose	12', 16'	N
24PB-BN	3/4 x 23-1/4" Bullnose	12', 16'	N
11PB	5/8 x 11-1/4" Bullnose Tape Edge	16'	S
12PB	5/8 x 15-1/4" Bullnose Tape Edge	16'	S
13PB	5/8 x 23-1/4" Bullnose Tape Edge	16'	S
16PB	3/4 x 11-1/4" Bullnose Tape Edge	16'	S
17PB	3/4 x 15-1/4" Bullnose Tape Edge	16'	S
18PB	3/4 x 23-1/4" Bullnose Tape Edge	16'	S



Closet Material

(items are approximate scale only)

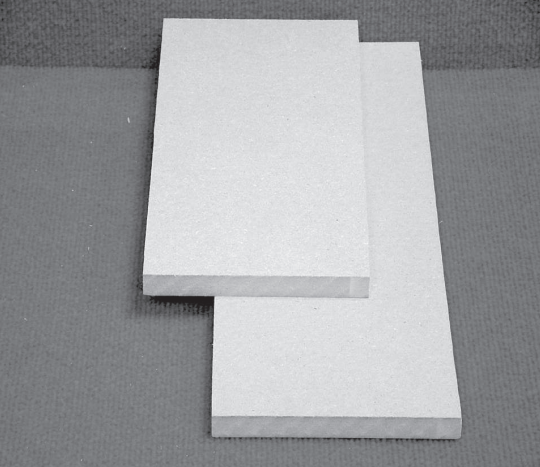
Unprimed MDF Shelving			
	PART#	SIZE	STOCKED LENGTH
	11MDF-F	11/16 x 11-1/4" MDF S4S	16'
	16MDF-F	11/16 x 15-1/4" MDF S4S	16'
	30MDF-F	11/16 x 30-1/2" MDF S4S	10', 16'
	11MDF-BN	11/16 x 11-1/4" MDF Bullnose Edge	16'
	16MDF-BN	11/16 x 15-1/4" MDF Bullnose Edge	16'
	11MDF-BN	11/16 x 11-1/4" MDF Bullnose Edge	16'
	12MDF-BN	11/16 x 15-1/4" MDF S4S	16'
	11MDF-2E	11/16 x 11-1/4" MDF 2 Eased Edge	16'
	12MDF-2E	11/16 x 15-1/4" MDF 2 Eased Edge	16'
	13MDF-F	11/16 x 23-1/4" MDF Square Edge	16'

Pine Shelving			
	PART#	SIZE	STOCKED LENGTH
	PS	11/16 x 11-1/4" #2 Common	6' - 16'

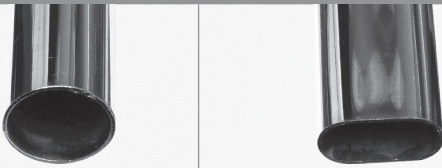
Chrome Pole			
	PART#	SIZE	STOCKED LENGTH
	CPR	1-1/16" Chrome Round Pole	8', 12'
	CPO	Chrome Oval Pole	8', 12'

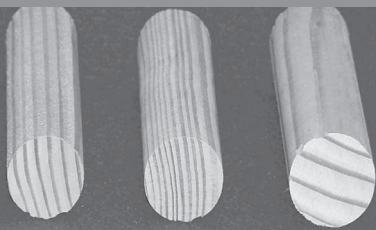
Fir & Pine Closet Pole			
	PART#	SIZE	STOCKED LENGTH
	F802	1-1/4" Fir Full Round	6' - 20'
	F802FJ	1-1/4" FJ Fir Full Round	16' + Trimbacks
	F803	1-3/8" Fir Full Round	6' - 20'
	P802FJ / 802FJ	1-1/4" FJ Pine Full Round	16' + Trimbacks
	802SP	1-5/6" Solid Pine Full Round	6' - 16'
	803SP	1-3/8" Solid Pine Full Round	6' - 20'

Pole Covers			
	PART#	SIZE	STOCKED LENGTH
	PC	White Plastic Pole Cover (for 1-1/4 or 1-3/8" full round)	12'

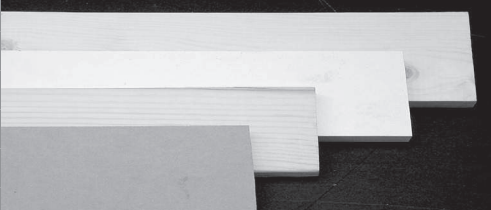
Hook			
	PART#	SIZE	STOCKED LENGTH
	15FB	9/16 x 3-1/4" IEE FB Hook	16'
	15FJ	9/16 x 3-1/4" FJ Pine Hookstrip	16'
	16FJ	11/16 x 4-1/2" FJ Rab't Hookstrip	16'
	MLH	5/8 x 3-1/4" Melamine Hook 1-Edge Banded	8'
	CH	3/4 x 3-1/2" #2 Common Pine Hook (1x4)	3'-16'

(items are approximate scale only)

Closet Material

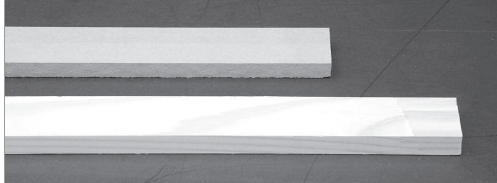
Cleat				
		PART#	SIZE	STOCKED LENGTH
		10FB	9/16 x 1-1/2" IEE FB Cleat	16'
		10FJ	9/16 x 1-1/2" FJ Pine 1EE Cleat	16'

N/S
N/S

Rosettes				
		PART#	SIZE	STOCKED LENGTH
		CRR	Chrome Rosette w/Nipple (use w/chrome pole-round)	—
		CRO	Chrome Rosette w/Nipple (use w/chrome pole-oval)	—
		CRO-NO	Chrome Rosette No Nipple (use w/chrome pole-oval)	—
		WR	Wood Rosette (100 PR p/box)	—
		PR	Plastic Rosette (2 PCS. p/bundle)	—

N/S
N/S
N/S
N/S
N/S

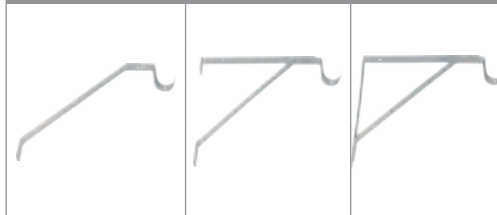
Brackets				
		PART#	SIZE	STOCKED LENGTH
		4750	Brackets (80 Pcs. p/box)	—
		4700	Swivel End Brackets (20 Pcs. p/box)	—
		4800	Heavy Duty Brackets (20 Pcs. p/box)	—

N/S
N/S
N/S

Support Bracket				
		PART#	SIZE	STOCKED LENGTH
		CPS-O	Chrome Oval Pole Support Bracket - (Oval Pole Only)	—

N/S

Plastic Shelf Supports				
		PART#	SIZE	STOCKED LENGTH
		SS	Plastic Shelf Supports	12 Pcs./Bag

N/S

Aromatic Cedar Closet Lining				
		PART#	SIZE	STOCKED LENGTH
		3CL	5/16 x 3-7/8" Aromatic Cedar T&G Closet Lining	8'
		4CL	5/16 x 4-7/8" Aromatic Cedar T&G Closet Lining	8'

S
S

Edge Banding				
		PART#	SIZE	STOCKED LENGTH
		EB1	5/8" Edge Banding	250' Roll
		EB2	3/4" Edge Banding	250' Roll

S
N/S

Big Ideas

(items are approximate scale only)



Pockets/Frames/ Composite Millwork



A FRAME FOR EVERY KIND OF OPENING



EL & EL Pocket Door Sliders are manufactured on our premises using a combination of track and hardware options: CoxUSA can hold door weights up to 150# or 225# with standard steel track. An optional upgrade is available for aluminum track that creates a quieter, stronger track. New, from Johnson Hardware, is 200# hardware that comes standard with aluminum track and offers an optional upgrade of a soft-close in or out feature. Also available is Häfele's track and hardware, "SlidoClassic" and Hawa Jr. 80/Z – an ADA approved pocket slider, that can hold up to 176# or 264# with anti-bounce back, aluminum track and easy removable track.

Composite frames and components offer an alternative choice to traditional wood door frames. Moisture, rot and insect resistant, this unique exterior door jamb and components will not absorb or wick moisture and never warp or splinter.

Framesaver offers traditional wood door frames that have a composite on the bottom 4", repelling moisture and wicking.

section contents

Brick Mold w/Stucco Key	352
Composite Exterior Frames & Mouldings	351
Frame Saver Door Frames.....	351
Kerfed T-Astragal.....	352
Mitered Brick Mold.....	352
Mull Covers	352
Pocket Sliders	349
Primed Composite Frames	350
Sidelite Stop	352
Track & Hardware Options.....	349

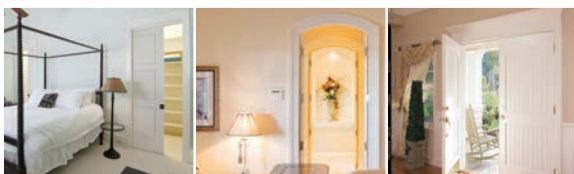

Pockets/Frames/ Composite Millwork

A FRAME FOR EVERY KIND OF OPENING



NEW OPTIONS NOW AVAILABLE

Aluminum Track: softer, smoother, quieter ride

Soft-close Doors: easier, smoother opening and/or closing

Synchronized Double Doors: both doors move in tandem

Pocket doors are an elegant and space-saving way to provide privacy and separate rooms.

FJ Pocket Sliders are available in standard sizes for next day delivery and other species are custom made to order. All wood parts of a pocket slider are made of pine, however, the finish (visible wood components) vary according to the specie ordered. Pocket sliders are available in paint grade, VG Doug Fir, Red Oak, Cherry, Mahogany, Alder and more. Door hanging hardware is included with each pocket slider, however, hardware for the door handle is not included.

We are pleased to now offer, as an upgraded option, Häfele track and hardware, considered the 'Cadillac' in sliding performance and ADA compliance. Suitable for door weights from 176lbs. to 264lbs., the sliding hardware requires less than 5lbs. of closing force. Also ADA compliant is the Hawa Jr-8oz. that provides superior quality and German engineering. (A non ADA compliant hardware that holds up to 528lbs. is also available.) Please note the spec variance from our standard pocket sliders when using Häfele track and hardware.

Composite frames and components offer an alternative choice to traditional wood door frames. Moisture, rot and insect resistant, this unique exterior door jamb and components will not absorb or wick moisture and never warp or splinter. A door frame with integrity today, tomorrow and years down the road. Door hinges are available in a wide selection for residential and commercial applications. Representing the best value in door hinges today. All items shown are in stock and ready to ship to your exact requirements.

space-savings

smooth transitions

beautifully private

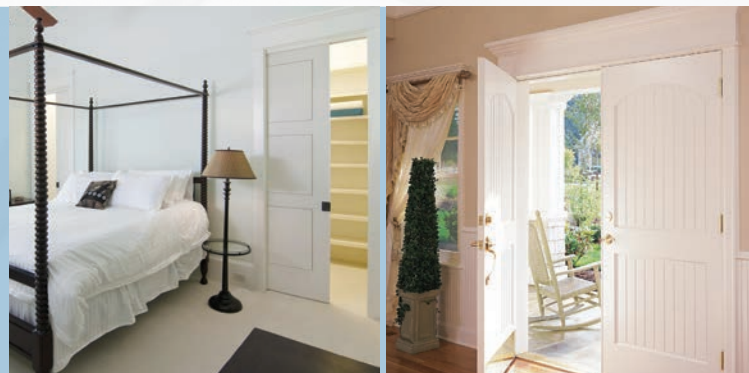

(Items are approximate scale only)

Pocket Sliders

Lengths available: all 6' thru 16'

Pocket Body Options



* The standard gap for a pocket slider door is 2" wide and works well for 1-3/8" doors. Slats are 3/4" common pine.

* 1-3/4" doors have a non standard gap that is 2-1/4" and may alter wall conditions by 1/4".



* Special order 1-3/4" doors = 1/2" ply slats on both sides with steel horizontal stiffeners creates a 2-1/4" gap and does not alter the wall condition.



FULL PLY

- The minimum pocket slider wall thickness is 3-1/2"
- Kerfed for bullnose pocket sliders available on special order.
- Options available:
 - 1) Aluminum track & stiffeners
 - 2) Hardware options for CoxUSA and Häfele Jr door weights are 150#, 176#, 200#, 225# and 528#
 - 3) 3-1/2", 10", 24" ply slats or full ply sides
 - 4) Steel or aluminum stiffeners on slats

Use Pocket Door Sliders:

- In rooms or areas where there isn't enough space for the door to swing
- To separate rooms with doors that can be hidden into the wall but also closed for privacy or separation
- As an architectural effect

Standard pocket door sliders are available in FJ Pine and VG Douglas Fir, Solid Pine, Red Oak, Poplar, Alder, and Cherry. Other species are available by special order.

Track & Hardware Options

CoxUSA Pockets (150 lbs. & 225 lbs.)

Our standard pocket is CoxUSA 150 lbs. which includes a steel 'C' track and 4-wheel axle hardware. Aluminum track is an upgrade option, with both 150 lbs. or 225 lbs. hardware. 225 lbs. pockets include a steel 'C' track and ball bearing hardware.

Johnson Hardware Pocket (200 lbs. Capacity)

Includes aluminum track and 3-Wheel Axle hardware with soft close option.

Häfele Hardware Pocket (170 lbs., 264 lbs. & 528 lbs. Capacity)

Includes aluminum track, 4-wheel ball bearing hardware with Quick Release and anti-bounce back stop. (Please note that 528 lbs. capacity hardware does not meet ADA compliance)

*Häfele Hawa Jr. 80/Z

German engineered to handle door weights up to 176 lbs., Hawa Jr. is the "Cadillac" of pocket door track and hardware. ADA approved anodized aluminum track with a soft close option, rattle-free bottom door guide, four (4) nylon wheeled running gear, and an adjustable tension anti-bounce back stop.

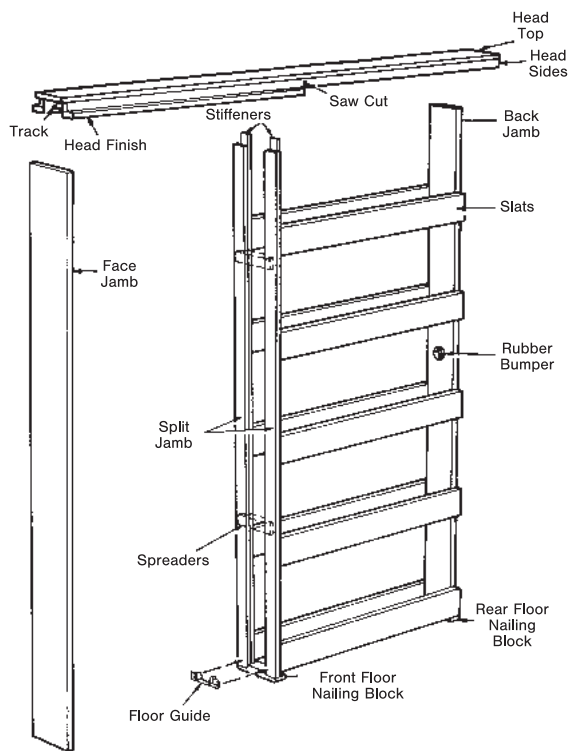

Finish Door Size (Single Door Opening)		2' - 0"	2' - 4"	2' - 6"	2' - 8"	3' - 0"
Rough Opening	Height	7' - 0"	7' - 0"	7' - 0"	7' - 0"	7' - 0"
	Width	4' - 2"	4' - 10"	5' - 2"	5' - 6"	6' - 2"
Frame Size	Height	6' - 11-5/8"	6' - 11-5/8"	6' - 11-5/8"	6' - 11-5/8"	6' - 11-5/8"
	Width	4' - 1-5/8"	4' - 9-5/8"	5' - 1-5/8"	5' - 5-5/8"	6' - 1-5/8"

For Double Doors

The rough opening on a Double Pocket is 4X the size of a single door + 1-1/2". Height is the same as listed for a single door pocket slider.

Using Häfele Tracking Hardware

The rough opening on a Single Door is 2X the door width + 2". Rough opening height is the door height + 5". A Double pocket door rough opening is 4X door + 1-1/2".

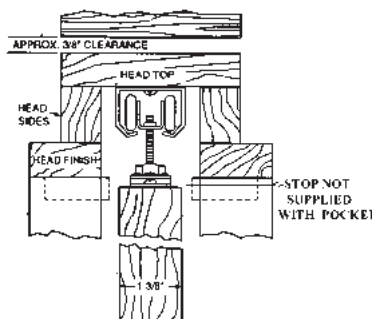

1. INSTALL HANGERS

Prior to installation, place hangers in track by fitting through hanger mounting space between track and jamb.

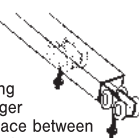

2. INSTALL HANGER BRACKETS

Screw all hanger brackets on door, 2-3/4" from edge of door to center of bracket.

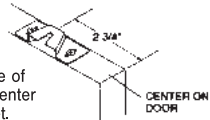

3. INSTALL AND ADJUST DOORS

Attach bracket to hanger by lifting door and inserting adjusting bolt into slot until bolt head becomes seated. Align doors by turning adjusting bolt with wrench. After final adjustment, tighten lock nut down to bracket as shown.

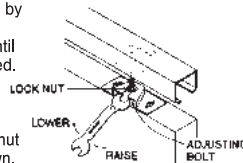

4. INSTALL FLOOR GUIDES

Nail nylon guide No. 04-002 to split jamb as shown, centering door in pocket.
NOTE: For 1-3/4" doors, cut out center section of nylon floor guide.



Primed Composite Frames

 lengths available: all 6' thru 16'

(items are approximate scale only)

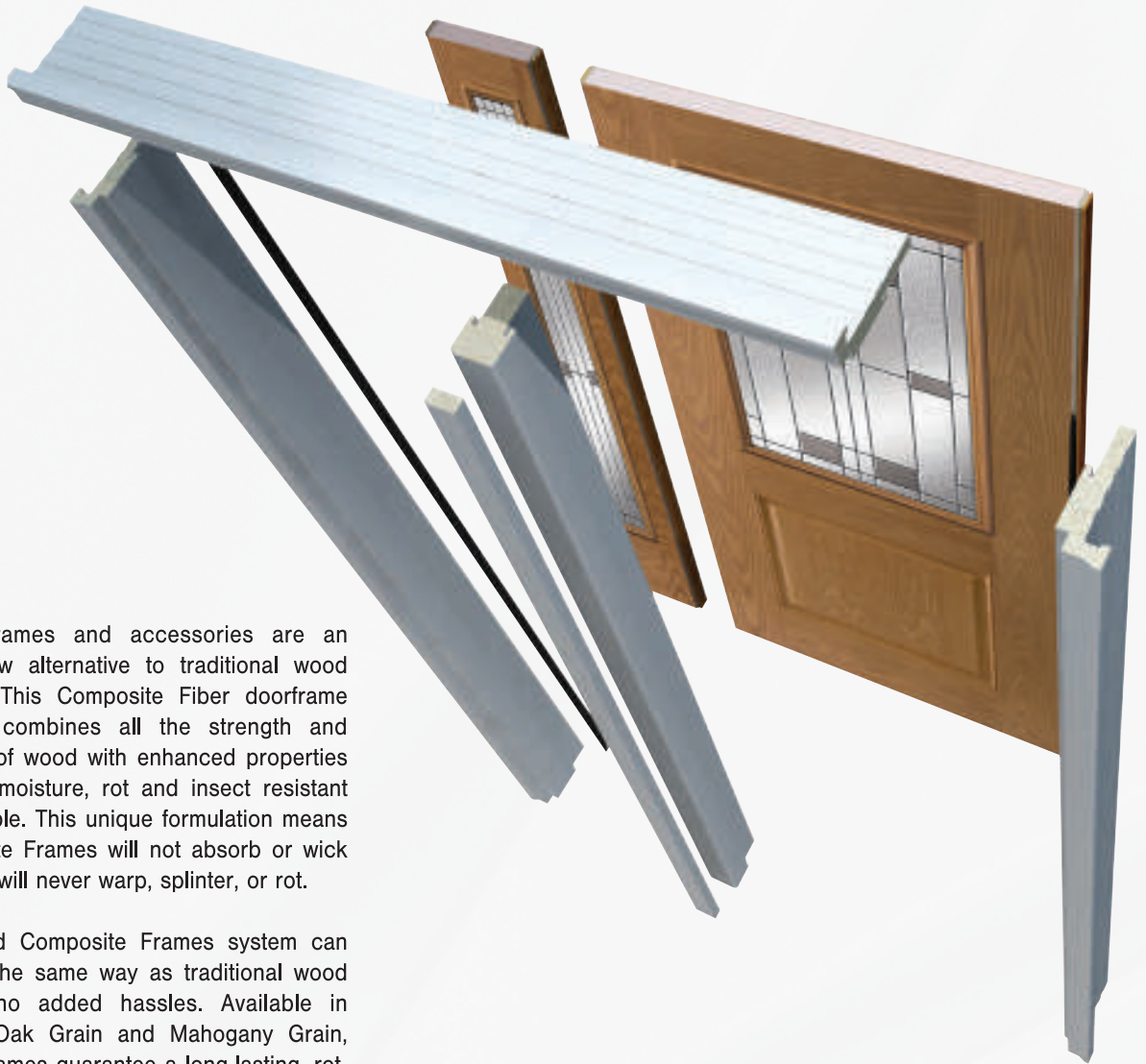

Composite frames and accessories are an innovative new alternative to traditional wood door jambs. This Composite Fiber doorframe system that combines all the strength and convenience of wood with enhanced properties that make it moisture, rot and insect resistant is now available. This unique formulation means that Composite Frames will not absorb or wick moisture and will never warp, splinter, or rot.

The advanced Composite Frames system can be matched the same way as traditional wood jambs with no added hassles. Available in Paint-grade, Oak Grain and Mahogany Grain, Composite Frames guarantee a long-lasting, rot-free entryway that will maintain its integrity today, tomorrow, as well as years down the road.

COMPOSITE FRAMES FEATURES & BENEFITS

CLOSED CELLULAR STRUCTURE ensures doorframe & molding will not absorb or wick moisture, and prevents warping, rotting and splitting

RIGID COMPOSITE FIBER FORMULATION eliminates the need for an aluminum support channel

TWICE THE SCREW-HOLDING POWER of traditional wood doorframes

EASILY MACHINED just like wood frames

VARIOUS LENGTHS

(items are approximate scale only)

Composite Exterior Frames & Moulding

 solid pine jamb lengths: 11/16" x 3-15/16" 6' thru 16'

Composite Door Frames

- Will Not Rot
- Insect Resistant

Primed **(CF)** Composite Fiber
 Oak Woodgrained **(WG)** Composite
 Mahogany **(MHG)** Composite

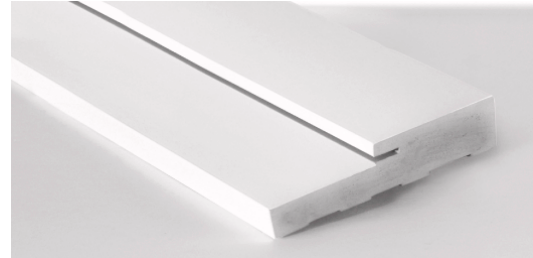

All frames are kerfed for weatherstrip

6/8 Frames: 81-1/4 BD x 1-1/4 x 1/2 x 2-1/8"

8/0 Frames: 97-1/4 BD x 1-1/4 x 1/2 x 2-1/8"

For a full set (head + 1 pair of sides), please order 1.5 pairs (1-1/2 pairs).

- WILL NOT ROT
- INSECT RESISTANT

Exterior Door Frames							
SIZE	Paintgrade (CF)		Woodgrain (WG) (stain or paint)		Mahogany Poly Fiber Frames™ (MHPG)		
	6/8	8/0	6/8	8/0	6/8	8/0	20/0
4-9/16	CF4916W6	CF4916W8	WG4916W6	WG4916W8	MHG4916W6	MHG4916W8	MHG4916W20
5-1/4	CF514W6	CF514W8	WG514W6	WG514W8	MHG514W6	MHG514W8	-
6-9/16	CF6916W6	CF6916W8	WG6916W6	WG6916W8	MHG6916W6	MHG6916W8	MHG6916W20
7-1/4	CF714W6	CF714W8	WG714W6	WG714W8	MHG714W6	MHG714W8	MHG714W20

*20' stock sold per piece only.

Frame Saver Door Frames

Frame Saver Door Frames

Primed FJ with a 4" rot-proof wood composite on bottom of each frame leg, keeping water & moisture from wicking into the wood frame.

SIZE	6/8	8/0
4-9/16	FS4916W6	FS4916W8
5-1/4	FS514W6	FS514W8
6-9/16	FS6916W6	FS6916W8
7-1/4	FS714W6	FS714W8



Door Trim

(items are approximate scale only)

✂ lengths available: all 6' thru 16'

(CF) Composite Fiber

(UR) Urethane

(WG) Oak Woodgrained Composite Fiber

- WILL NOT ROT
- INSECT RESISTANT

7/8" x 1-1/2" Stucco Mold		
	PART #	LENGTH
	UR953	7' & 17'
	CFSM	18'

1" x 2" Mull Cover		
	PART #	LENGTH
	CFMULLC8	8' 0"
	WGMULLC8	8' 0"

1-1/4" x 2" WM180 Brick Mold (w/Stucco Key)		
	PART #	LENGTH
	UR612B	7' & 17'
	CFBKMK	17'

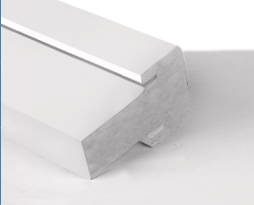
1 x 2" x 4-3/8" Primed LVL Mull Post		
	PART #	LENGTH
	PGLVL438MULL8	8' 0"

1-1/4" x 2" WM180 Mitered Brick Mold (no key)		
	PART #	LENGTH
	CFBKM6 <small>(Mitered 82-15/16")</small>	6' 8"
	CFBKM8 <small>(Mitered 98-15/16")</small>	8' 0"
	WGBKM6 <small>(Mitered 82-15/16")</small>	6' 8"
	WGBKM8 <small>(Mitered 98-15/16")</small>	8' 0"

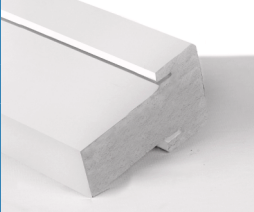
1-1/2" x 2-1/2" x 4-3/8" LVL Primed Fat Boy Mull Post		
	PART #	LENGTH
	PGLVL212MULL8	8' 0"

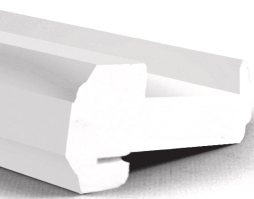
1-1/2" x 3-1/4" Kerfed T-Astragal		
	PART #	LENGTH
	CFAST8 <small>(Formerly PCAST8)</small>	8' 0"
	WGAST8	8' 0"

3/8" x 5/8" Sidelite Stop		
	PART #	LENGTH
	CFSLSTOP	99"
	WGSLSTOP	99"



Your home is a reflection of who you are. That's why we've designed a range of doors and glass options to help express a character that is undeniably yours.

EL & EL and our partners have come together to offer the most comprehensive line of Interior Door Units in the market place today. Choose from trusted brands like Simpson, Masonite, Trimlite or CoxUSA in a wide variety of species, available in a multiplicity of sizes for every opening and every taste. **Explore all your options inside our complete Door Catalog or visit us online at ELandELWoodProducts.com.**

section contents

Barn Door Collection	357
Dividers by CoxUSA™	357
Masonite® Knotty & Clear Pine.....	355
Masonite® Moulded.....	356
Primed & Pine Louver	354
Raised Panel Moulding MDF.....	353
Shaker Series.....	354
Simpson® Interior.....	355
Superior & Knotty Alder	353
Trimlite Decorative	356

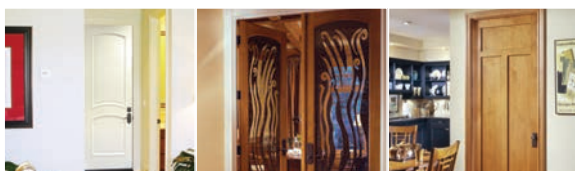

Interior Doors

DESIGN STYLES

ALL

**JANKA
HARDNESS**
(POUNDS-FORCE)

I
varies

PREP

- 1 Before applying the first coat of finish, remove all handling marks, any raised grain and other undesirable blemishes by sanding all surfaces with 180 grit sandpaper. (For doors with shaker sticking, lightly ease the outside edge of the sticking with sandpaper.) To avoid cross-grain scratches, sand with the grain.
- 2 After sanding, clean door thoroughly with a cloth to remove all dust or foreign material. Do not use caustic or abrasive cleaners.
- 3 Adjust or align components, if necessary, before finishing. Wood panels “float” and may be knocked into alignment with a wood block and hammer. Be careful not to damage door.
- 4 Hang door before finishing, and then remove to finish properly. All surfaces of the door must be properly finished. The edges (top, bottom and sides) should be coated with each and every coat of finish that is applied to the exterior surface of the door. Doors must be properly sealed prior to installation of hardware and exposure to moisture or weather. Doors must be dry before finishing. Properly finish door immediately before prolonged storage.
- 5 On doors that are glazed with clear glass, the finish used should be flowed from the wood slightly onto the glass. This will provide assurance against water leakage and protect the glazing compound “putty” from drying out. It is the finisher’s responsibility to protect glass prior to and during finishing. If using tape, conduct a test of the tape being used on a small area of the glass before applying to a large surface. After finishing, remove the tape as soon as possible.

ALWAYS PROPERLY FINISH ALL SIDES AND EDGES OF YOUR DOOR. **ALWAYS** PROPERLY SEAL YOUR DOOR BEFORE ADDING HARDWARE OR EXPOSING TO MOISTURE OR WEATHER. **ALWAYS** PROPERLY FINISH YOUR DOOR BEFORE PROLONGED STORAGE.

FINISHING

Your new door has been crafted with only the finest materials and you can choose from a wide variety of stains or paint possibilities.

Paint dealers have a broad selection of color chips on hand to demonstrate the look you can achieve when staining fine wood i.e. Douglas Fir or Pine or if you are painting, you can apply either oil-base or acrylic resin-based paints over an oil-base primer.

Take care in following the manufacturers finishing instructions. Always be sure to evaluate the conditions your door must endure before deciding on the specific finish to use.

All doors must be finished shortly before or after installation.

FITTING & HANGING

- * When hanging a door, allow adequate clearance for any swelling of door or frame in damp weather.
- * Allow approximately 3/16” clearance for swelling when the door is installed in fully dry conditions.
- * Jams must be plumb.
- * Avoid excessive warping or drying. Do not store or install your door in a damp or freshly dry-walled building.
- * Keep the door at least 10 feet away from heating registers, and away from direct sunlight.
- * Do not cut doors down in height by more than the allowable amount per each manufactures specifications. Care should be taken in cutting doors down in width to avoid exposing engineered components.
- * Use a sharp fine-tooth saw for trimming edges and ends of doors. Jams and stops must be set square and plumb.



Raised Panel Moulding MDF Doors



6/8 and 8/0 1-3/4" thick

- Hand-built construction for an architecturally correct raised panel and raised moulding design – better value than typical wood doors
- 1-3/4" solid core door provides a much quieter environment than lighter weight hollow core doors
- "Seamless Construction" - one piece solid MDF veneer eliminates seam separation, typical in stile and rail construction
- Finger joint pine edge, along the top rail and stiles and full 3-1/8" solid wood edge at the bottom rail, allows for jobsite trimming on all sides for a custom fit
- Premium lacquer-based primer is standard
- Environmentally friendly materials
- No warping, cracking or seam separations
- Flush moulding door available for bypass and pocket doors

FIRE DOOR OPTION AVAILABLE ON 2/8 and 3/0 DOORS.



Superior & Knotty Alder Doors



6/8 and 8/0 1-3/8" & 1-3/4" thick

- Superior and Knotty Alder doors are available in interior and exterior Arch Top 2-panel
- Knotty Alder doors also available in Square Top Shaker and 1-lite styles
- Engineered stiles and rails are sturdier and less susceptible to warping and bending in the life of a door. The appearance is the same as non-engineered stiles and rails, but the core is made up of multiple pieces of wood for improved strength and durability.

TWO PANEL 20-MINUTE POSITIVE PRESSURE FIRE RATED DOOR OPTIONS AVAILABLE



EXPLORE ALL DOOR OPTIONS IN THE EL & EL DOOR CATALOG OR ONLINE AT ElandELWoodProducts.com

Shaker Series Doors



(SH782 shown)

6/8, 7/0 and 8/0 1-3/8" & 1-3/4" thick

- Premium Primed Square and Ovolo Sticking
- Craftsman style options in Vertical Grain Doug Fir, Square and Ovolo Sticking
- Bi-fold options in Primed and Vertical Grain Doug Fir
- MDF overlayed on a wood lumber core

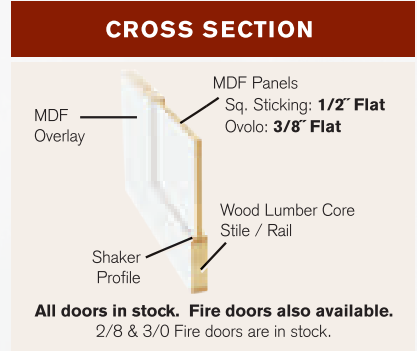

FIRE DOOR OPTIONS AVAILABLE

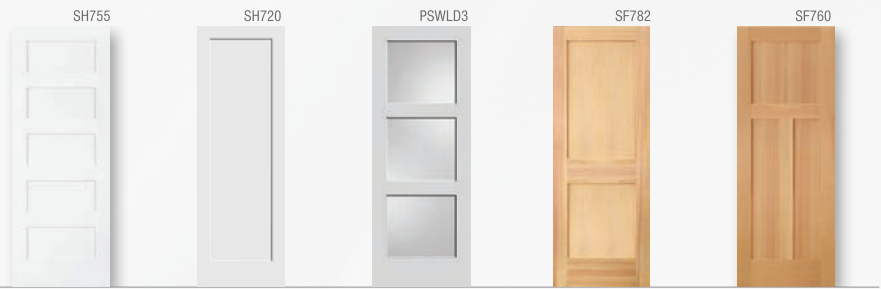

Primed & Pine Louver Doors



(PBPLL shown)

6/8 and 8/0 1-3/8" thick

- 1-3/8" Louver Interior Doors available in louver-louver or louver-panel Pine and primed MDF
- Bi-fold, Plantation and Louver Shutter door options
- Bi-fold doors include easy instructions, knobs, hardware, track and aligner to install as 4-door unit.



EXPLORE ALL DOOR OPTIONS IN THE EL & EL DOOR CATALOG OR ONLINE AT ElandELWoodProducts.com

Knotty and Clear Pine Doors



(K2PA shown)



6/8 and 8/0 1-3/8" thick

- Real wood doors designed to accentuate any room
- Featuring traditional & contemporary panel configurations
- Stain or clear coat to complement your décor
- Available as a Bifold and Fire Door
- Available as Clear Pine (no knots)

20-MINUTE POSITIVE PRESSURE FIRE RATED DOOR OPTIONS AVAILABLE



Simpson® Interior Doors



(CUSTOM DOOR shown)



- FRENCH DOORS - All French doors are stocked in Douglas Fir or Redi-Prime® (as noted) with 1/8" SG, 1-3/8" thick, 6'8" height unless otherwise noted, widths as indicated.
- RAISED PANEL DOORS - All raised panel doors are stocked in Douglas Fir with a 3/4" double hip-raised panel, 1-3/8" thick, 6'8" height and widths as indicated.
- FLAT PANEL DOORS - All raised panel doors are stocked in Douglas Fir with a 3/4" flat panel, 1-3/8" thick, ovolo sticking 6'8" height and widths as indicated.
- SPECIAL ORDER & CUSTOM DOORS - Whatever your project needs are, Simpson can build the door to your exact specifications. Any Design. Any Size. Any Shape. Any Wood Species. Visit the Simpson Doormagination® tools at simpsondoor.com/doormagination.

FIRE RATED DOOR OPTIONS AVAILABLE



EXPLORE ALL DOOR OPTIONS IN THE EL & EL DOOR CATALOG OR ONLINE AT ElandELWoodProducts.com

Trimlite Decorative Doors



(RAW SILK shown)



6/8 and 8/0 1-3/4" thick

- Interior home decor is a very personal thing. Finding the style that reflects your wants and compliments your living space is very important. Our design team understands this. From our selection of French doors with glass installments to our interior shaker panel doors, you will find a style that is a true reflection of your taste.
- Choose from French to Shaker to Mid Century Modern and beyond. Bubbles, lines, slight surface imperfections or discolourations are characteristics of all hand crafted glass. They are not considered defects; they add character.



Masonite® Molded Door Collection



(BERKLEY shown)



Five distinct categories make it easy to match your unique style.

- Classics™, Heritage®, Select™ and Palazzo® are all Finger Joint Stiles and also available as bifold doors.
- The West End Collection complements your modern or contemporary style.
- Engineered design provides stability and value to better withstand the dents and dings associated with normal wear and tear.
- Making the move to solid core doors blocks sound more effectively when privacy is key.

FIRE RATED DOOR OPTIONS AVAILABLE

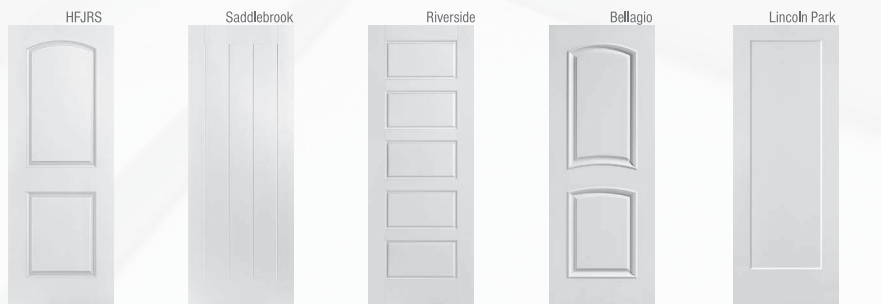

EXPLORE ALL DOOR OPTIONS IN THE EL & EL DOOR CATALOG OR ONLINE AT ElandELWoodProducts.com



Dividers by CoxUSA



DIVIDERS by COXUSA

- Available in single, double, triple, and quad panel systems
- Available with 4 standard glass options: Mirror, White Lami, Polar White, Black
- Offered in 4 standard frame finishes: Black, White, Java, and Satin Aluminum
- Optionally choose from 4 decorative rail options: 2-lite, 3-lite, 4-lite, and 5-lite
- ADA standards compliant for push/pull force
- Latches and pulls for privacy and passage applications
- 150 lbs. maximum panel weight



Barn Door Collection



(180 shown)

2/6, 3/0, 3/6 x 7/0 and 8/0 1-3/8" thick

- Choose from three unique styles, species and hardware options
- Center/cross mulls, that are full thickness, insure the stile meets flush at the stile and rail joints for a truly custom finish
- Deeper V-Grooves accentuate the plank style and design
- Panels are 3/4" edge glued for durability and strength

SPECIES



Primed MDF



Knotty Alder



Knotty Pine



180



181



183

HARDWARE



EXPLORE ALL DOOR OPTIONS IN THE EL & EL DOOR CATALOG OR ONLINE AT ElandELWoodProducts.com



Big Ideas

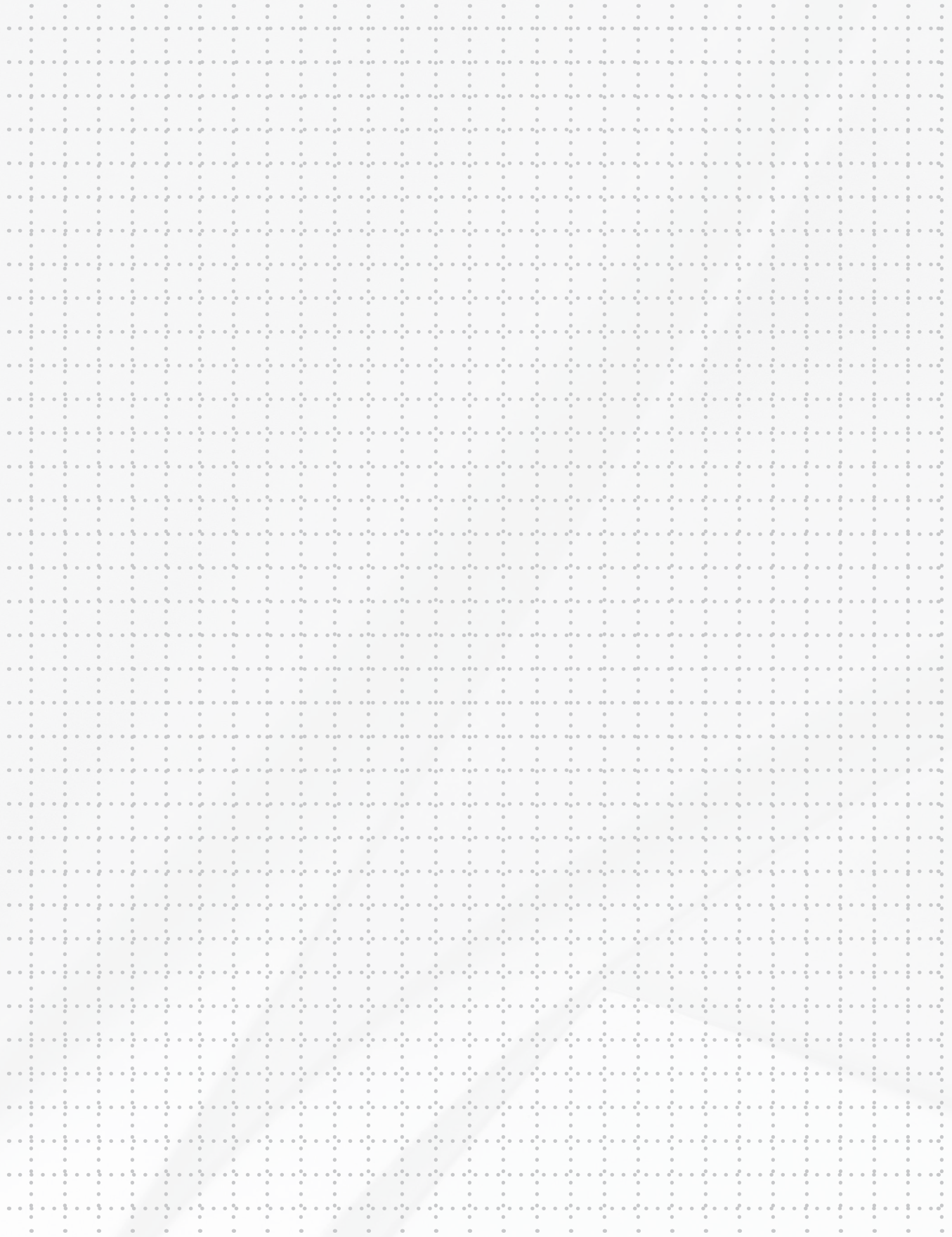

Big Ideas



Big Ideas



Exterior Doors

SOUNDNESS. STABILITY. CHARACTER.



The entryway – where you greet family and friends. An important focal point that enhances curb appeal and adds value to your home. That’s why we’ve created an extensive collection of doors and accessories, making it easy for you to make an opening statement.

EL & EL and our partners have come together to offer the most comprehensive line of Exterior Door Units in the market place today. Choose from trusted brands, like Simpson, for a wide variety of species, sizes and styles, for every opening and every taste. **Explore all your options inside our complete Door Catalog or visit us online at ELandELWoodProducts.com.**

section contents

Fiberglass Exterior Doors	361
Knotty Alder Exterior Doors	364
Modern Door Collection.....	363
Doorlites	361
Prefinished Fiberglass Doors.....	362
Rediframe® Prefinished Steel Door Frames.....	364
Retrofit Patio Doors.....	362
Simpson® Exterior Wood Doors.....	363



Exterior Doors

DESIGN STYLES

ALL

JANKA
HARDNESS
(POUNDS-FORCE)

E
varies

PREP

- 1 Before applying the first coat of finish, remove all handling marks, any raised grain and other undesirable blemishes by sanding all surfaces with 180 grit sandpaper. (For doors with shaker sticking, lightly ease the outside edge of the sticking with sandpaper.) To avoid cross-grain scratches, sand with the grain.
- 2 After sanding, clean door thoroughly with a cloth to remove all dust or foreign material. Do not use caustic or abrasive cleaners.
- 3 Adjust or align components, if necessary, before finishing. Wood panels “float” and may be knocked into alignment with a wood block and hammer. Be careful not to damage door.
- 4 Hang door before finishing, and then remove to finish properly. All surfaces of the door must be properly finished. The edges (top, bottom and sides) should be coated with each and every coat of finish that is applied to the exterior surface of the door. Doors must be properly sealed prior to installation of hardware and exposure to moisture or weather. Doors must be dry before finishing. Properly finish door immediately before prolonged storage.
- 5 On doors that are glazed with clear glass, the finish used should be flowed from the wood slightly onto the glass. This will provide assurance against water leakage and protect the glazing compound “putty” from drying out. It is the finisher’s responsibility to protect glass prior to and during finishing. If using tape, conduct a test of the tape being used on a small area of the glass before applying to a large surface. After finishing, remove the tape as soon as possible.

ALWAYS PROPERLY FINISH ALL SIDES AND EDGES OF YOUR DOOR. ALWAYS PROPERLY SEAL YOUR DOOR BEFORE ADDING HARDWARE OR EXPOSING TO MOISTURE OR WEATHER. ALWAYS PROPERLY FINISH YOUR DOOR BEFORE PROLONGED STORAGE.

FINISHING

Your new door has been crafted with only the finest materials and you can choose from a wide variety of stains or paint possibilities.

Paint dealers have a broad selection of color chips on hand to demonstrate the look you can achieve when staining fine wood i.e. Douglas Fir or Pine or if you are painting, you can apply either oil-base or acrylic resin-based paints over an oil-base primer.

Take care in following the manufacturers finishing instructions. Always be sure to evaluate the conditions your door must endure before deciding on the specific finish to use.

All doors must be finished shortly before or after installation.

FITTING & HANGING

- * When hanging a door, allow adequate clearance for any swelling of door or frame in damp weather.
- * Allow approximately 3/16” clearance for swelling when the door is installed in fully dry conditions.
- * Jambs must be plumb.
- * Avoid excessive warping or drying. Do not store or install your door in a damp or freshly dry-walled building.
- * Keep the door at least 10 feet away from heating registers, and away from direct sunlight.
- * Do not cut doors down in height by more than the allowable amount per each manufactures specifications. Care should be taken in cutting doors down in width to avoid exposing engineered components.
- * Use a sharp fine-tooth saw for trimming edges and ends of doors. Jambs and stops must be set square and plumb.



BMT-122-817-1



BLS-122-152-725-T



BLS-122-928-X



Fiberglass Exterior Doors



Craftsmanship

It's traditional craftsmanship meets new world technology that makes Fiberglass Entry Doors the most advanced products available on the market today.

Quality

Innovative manufacturing methods include our fully integrated, computer-controlled system that enables greater product consistency and enhanced employee safety.

Reliability

Fiberglass exterior doors have been put through a rigorous battery of tests, first in their own testing lab and again by an independent facility.

Choice

Choose from the widest range of styles, textures and sizes found anywhere.



Doorlites



Upgrade Your Entry with **Privacy and Style**

- Accented with several varieties of decorative glass components and coming options.
- Fused between two panes of clear tempered glass for added energy efficiency and strength.
- Achieve your desired level of privacy with frosted glass, powerful bevels, cordless mini-blinds or ornate coming.

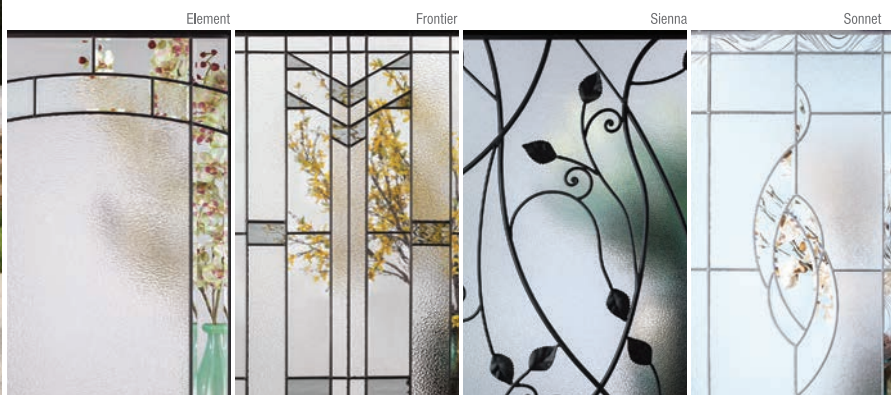

EXPLORE ALL DOOR OPTIONS IN THE EL & EL DOOR CATALOG OR ONLINE AT ELandELWoodProducts.com

Prefinished Fiberglass Doors - Color Options



(Belleville® Hollister® Smooth with Chelsea® Glass / Door BLS-404-341-1)

FEATURES

- Prefinishing Available on all Four Wood Grain Styles
- 9 Standard Stains, 10 Standard and 6 Contemporary Paint Color Options
- Custom Colors Available Using the Dunn Edwards Paints Color Palette
- Split Finishes Available
- 2 Year Limited Warranty (*Residential Only*)

STANDARD TEXTURED FIBERGLASS STAIN COLORS (Shown in Oak Grain)



CONTEMPORARY CLASSIC PAINT COLORS

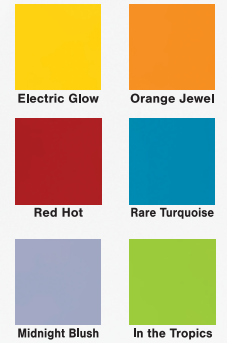

STANDARD PAINT COLORS

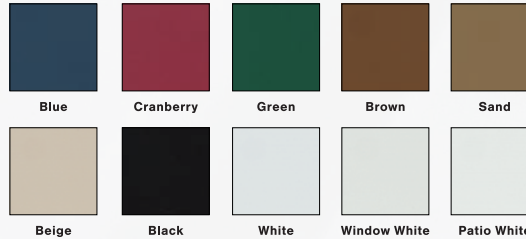

EXPLORE ALL DOOR OPTIONS IN THE EL & EL DOOR CATALOG OR ONLINE AT ElandELWoodProducts.com

EL & EL Elite Series Retrofit Patio Doors



FEATURES

- Single, Double, Triple or Quad Door Styles
- Low-E, Raise-Lower-Tilt Mini Blinds
- Five Handle Designs in Five Popular Finishes
- Weather-resistant Door Frames
- Easy-locking Multi-point Sidelights
- The Ultimate Performance Glass

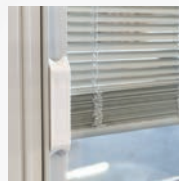

Optional Handle Sets

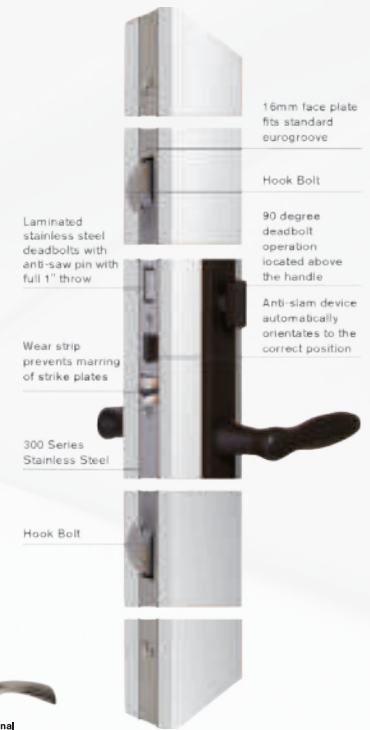

18mm face plate fits standard eurogroove

Hook Bolt

90 degree deadbolt operation located above the handle

Anti-slam device automatically orientates to the correct position

Laminated stainless steel deadbolts with anti-saw pin with full 1" throw

Wear strip prevents marring of strike plates

300 Series Stainless Steel

Hook Bolt

Modern Door Collection



- Expertly blended simplicity with stark design
- The sky is the limit with creativity and personalization—choose from numerous decorative glass and finish options.
- Finish your new door with the perfect hardware, including stainless steel and ultra modern barn door hardware options.

DRS00 w/842 Frosted Glass



4972



Smooth 14lite w/Rain Glass



Double H-Groove



7405 w/White Lami



(V-Style Groove)

Simpson® Exterior Wood Doors



- Choose from popular wood door styles like: Arts & Crafts, Colonial, Contemporary, or our extensive collections like Nantucket®, Mastermark®, or Artist.
- Select any wood species from traditional to exotic.
- Choose from a variety of textured and obscure glass options to fit your style and personality.
- Patented Ultrablock® technology adds a water-resistant composite block in the bottom of the door stiles.
- Waterbarrier® technology, combines medium density overlay with PVC glazing for exterior French doors.

77660
w/Clear Glass in Sapelle Mahogany



49906
w/Clear Glass in Walnut



7109
w/Thermal (TDL) Glass in Fir



6841
w/Solano II Glass in Fir

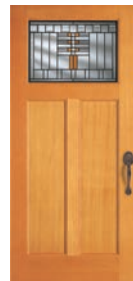

6356
w/Greenwich Glass in Fir



(6841 Solano II w/6171 Sidelight)

EXPLORE ALL DOOR OPTIONS IN THE EL & EL DOOR CATALOG OR ONLINE AT ElandELWoodProducts.com

Knotty Alder Exterior Doors



FEATURES

- Knotty Alder is a warm, inviting fine grained hardwood that adds rustic charm to any home
- Exposed knots, color variations, and mineral streaks add character and traditional appeal
- Precision-crafted with true stile & rail construction
- Stain and/or seal for a beautiful rustic finish

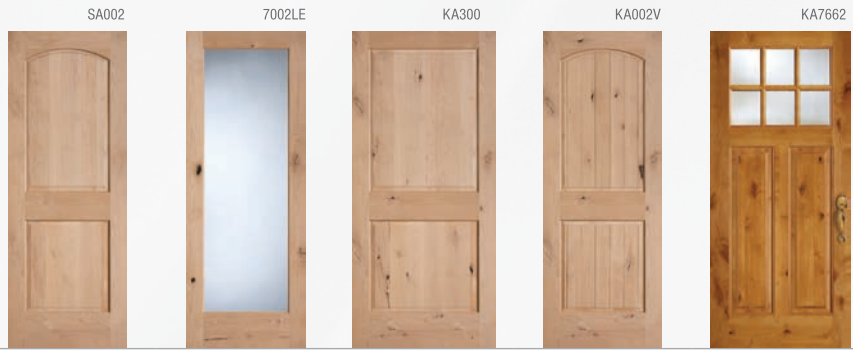

EXPLORE ALL DOOR OPTIONS IN THE EL & EL DOOR CATALOG OR ONLINE AT ELandELWoodProducts.com

Rediframe® Prefinished Steel Door Frames



FEATURES

- Interior and Exterior Applications
- Cased, Conventional or Pair-of-Door Opening Options
- UL10B and UL10C Fire-rated
- 5 Casing Material Options
- Standard Hardware Hinge & Strike Locations
- Standard and Custom Color Options Available
- Easy Installation



Part Number Index

FIND A PRODUCT FAST



feel
free
to
create



PART NUMBER	PAGE
-------------	------

Part Number Index

024.....	97	6586.....	181	1103LDF.....	253	120ALD.....	278
224.....	97	6588.....	181	1103MUL.....	253	120BSP.....	102
286.....	98	060A.....	8	1104LDF.....	253	120C.....	278
371.....	94	061A.....	8	1105LDF.....	253	120KA.....	278
372.....	94	062A.....	8	1105MUL.....	253	120MH.....	278
381.....	99	063A.....	8	1106LDF.....	253	120MP.....	278
387.....	97	064A.....	8	1107LDF.....	253	120MUL.....	185
388.....	97	065A.....	8	1107MUL.....	253	120P.....	278
430.....	94	066A.....	8	1108LDF.....	253	120SP.....	102
432.....	94	067A.....	8	1108MUL.....	253	120VG.....	257
433.....	94	068A.....	8	110BSP.....	102	121FJ.....	126
604.....	95	069A.....	8	110FJ.....	126	121MUL.....	185
606.....	95	070A.....	8	110MUL.....	187	121SP.....	102
607.....	97	071A.....	8	110SP.....	102	122MUL.....	189
614.....	95	072A.....	8	1114FI6.....	270	122MUL-SC.....	189
616.....	97	100SP.....	101	1114FI8.....	270	122SP.....	103
618.....	98	101FJ.....	125	1114FIL.....	270	125-O.....	280
619.....	98	101SP.....	101	1114I6.....	182	125ALD.....	280
627.....	98	102-O.....	277	1114I8.....	182	125C.....	280
629.....	97	102FJ.....	125	1114OI6.....	332	125KA.....	280
630.....	99	102MUL.....	185	1114PI6.....	332	125MH.....	280
634.....	99	103-O.....	277	1114PI8.....	332	125MP.....	280
638.....	98	103BFJ.....	126	1114PIL.....	332	125MUL.....	189
639.....	98	103BSP.....	102	111SP.....	101	125P.....	280
640.....	99	103FJ.....	126	112SP.....	101	126-O.....	283
642.....	99	103MUL.....	185	113SP.....	101	126FJ.....	130
710.....	93	103SP.....	102	114-O3.....	280	126MUL.....	194
711.....	93	104SP.....	101	114MH-3.....	280	126MUL-SC.....	194
712.....	93	105SP.....	101	114QWO-3.....	280	126P.....	283
713.....	93	106BSP.....	102	114SP.....	105	127MUL.....	189
714.....	93	106SP.....	102	114VG-3.....	257	128-O.....	278
715.....	93	107-O.....	277	114VG-5.....	258	128ALD.....	278
716.....	93	107MUL.....	185	114WL-3.....	280	128C.....	278
717.....	93	107SP.....	101	115-O.....	278	128FJ.....	127
718.....	93	108-O.....	278	115FJ.....	128	128KA.....	278
719.....	93	108ALD.....	278	115SP.....	103	128MH.....	278
720.....	93	108FJ.....	127	116SP.....	103	128MP.....	278
721.....	93	108MH.....	278	117FJ.....	134, 141	128MUL.....	187
722.....	93	108MUL.....	187	117SP.....	105	128P.....	278
723.....	93	108P.....	278	118-O4.....	291	129-O.....	280
724.....	93	108SP.....	103	118FJ-4.....	136, 143	129ALD.....	280
725.....	93	108VG.....	257	118MUL-3.....	193, 202	129C.....	280
771.....	95	1098LDF.....	253	118MUL-4.....	205	129KA.....	280
772.....	95	1098MUL.....	253	118MUL-5.....	213	129MH.....	280
773.....	94	1099LDF.....	253	118MUL-7.....	217	129MP.....	280
774.....	94	1099MUL.....	253	118P-4.....	291	129MUL.....	190
793.....	95	109SP.....	101	118P-5.....	294	129P.....	280
794.....	95	10BB.....	7	118SP-4.....	105	12BB.....	7
795.....	95	10BB-O.....	7	119-O.....	280	12BB-O.....	7
1400.....	97	10BRS.....	274	119FJ.....	129	12FOS.....	328
4126.....	181	10FB.....	347	119MUL.....	189	12MDF-2E.....	254, 346
4128.....	181	10FB.....	252	119P.....	280	12MDF-BN.....	254, 346
4186.....	181	10FJ.....	347	119SP.....	104	12OS.....	328
4188.....	181	10FOS.....	328	11BB.....	7	12PB.....	254, 345
4586.....	181	10OS.....	328	11BB-O.....	7	130-O.....	277
4588.....	181	10RS.....	274	11MDF-2E.....	254, 346	130MUL.....	185
4700.....	347	1100LDF.....	253	11MDF-BN.....	254, 346	130P.....	277
4750.....	347	1100MUL.....	253	11MDF-F.....	254, 346	130SP.....	101
4800.....	347	1101LDF.....	253	11PB.....	254, 345	131-O.....	278
6186.....	181	1101MUL.....	253	11PB-BN.....	254, 345	131MUL.....	187
6188.....	181	1102LDF.....	253	120-O.....	278	131SP.....	103



Part Number Index

132ALD.....	278	150MUL.....	188	162BFJ.....	127	176ALD.....	281
132MUL.....	187	150P.....	278	162FJ.....	127	176C.....	281
132P.....	278	150SP.....	103	162FJ-3.....	132	176FJ.....	132
133-O.....	284	152-O.....	277	162MUL-2.....	186	176KA.....	281
133ALD.....	284	152ALD.....	277	162MUL-3.....	191	176MH.....	281
133MUL.....	190	152B-O.....	277	163FJ.....	128	176MP.....	281
133P.....	284	152BMUL.....	186	164FJ.....	128	176MUL.....	192
134MUL.....	187	152C.....	277	164MUL.....	188	176MUL-SC.....	192
135ALD.....	280	152FJ.....	127	165ALD.....	283	176P.....	281
135KA.....	280	152KA.....	277	165C.....	283	176SP.....	104
135MUL-2.....	187	152MH.....	277	165FJ.....	129	176VG.....	257
135MUL-3.....	191	152MP.....	277	165KA.....	283	177ALD.....	284
135MUL-3SC.....	191	152MUL.....	186	165MH.....	283	177C.....	284
137MUL.....	187	152P.....	277	165MP.....	283	177KA.....	284
138FJ.....	134	152SP.....	102	165MUL.....	190	177MH.....	284
138MUL.....	188	152VG.....	257	165P.....	283	177MP.....	284
139-O.....	281	154FJ-3.....	131	166ALD.....	283	177MUL.....	195
139ALD.....	281	154MUL.....	191	166C.....	283	177P.....	284
139C.....	281	155-O.....	283	166KA.....	283	178ALD.....	279
139KA.....	281	155ALD.....	283	166MH.....	283	178C.....	279
139MH.....	281	155BSP.....	104	166MP.....	283	178MH.....	279
139MP.....	281	155FJ.....	134	166MUL.....	195	178MP.....	279
139MUL.....	191	155MUL.....	194	166P.....	283	178MUL.....	187
139MUL-SC.....	191	155P.....	283	167-O.....	278	178P.....	279
139P.....	280	155SP.....	104	167ALD.....	278	179-O.....	277
139SP.....	104	156-O.....	283	167C.....	278	179ALD.....	277
139VG.....	258	156FJ.....	135	167FJ.....	127	179C.....	277
13BB.....	7	156MUL.....	194	167MH.....	278	179M.....	277
13BB-O.....	7	156VG.....	258	167MP.....	278	179MP.....	277
13MDF-F.....	254, 346	157FJ.....	128	167MUL.....	187	179MUL.....	195
13PB.....	254, 345	157MUL.....	188	167P.....	278	179P.....	277
140-O.....	286	158-O.....	282	168-O.....	279	17PB.....	254, 345
140MUL.....	197	158ALD.....	282	168MUL.....	189	180MUL.....	193
140P.....	286	158C.....	282	168P.....	279	180P.....	282
140VG.....	258	158FJ-3.....	135	169-O.....	279	181MUL.....	189
141-O.....	277	158MH.....	282	169B-O.....	279	183BB.....	7
141P.....	277	158MP.....	282	169FJ.....	129	183BB-O.....	7
141SP.....	102	158MUL-2.....	186	169MUL.....	188	183MUL.....	196
141VG.....	257	158MUL-3.....	193	169SP.....	103	184-O.....	286, 320
142SP.....	101	158MUL-4.....	198	16BB.....	6	184MUL.....	192
143MUL.....	197	158MUL-5.....	200	16BB-O.....	6	185ALD.....	284
143SP.....	102	158P.....	282	16FJ.....	346	185BB.....	6
145MUL.....	199, 253	159FJ.....	128	16MDF-BN.....	346	185BB-O.....	6
145SP.....	103	159MUL.....	188	16MDF-F.....	254, 346	185MUL.....	199
146MUL-2.....	185	159P.....	279	16PB.....	254, 345	186-O.....	282
146MUL-3.....	193	15BB.....	6	16PB-BN.....	254, 345	186ALD.....	282
146MUL-4.....	198	15BB-O.....	6	170FJ.....	132	186BB.....	6
147FJ.....	129	15FB.....	254, 346	170MUL.....	192	186BB-O.....	6
147MUL.....	194	15FJ.....	346	172MUL-2.....	186	186C.....	282
148MUL.....	198	160-O.....	281	172MUL-3.....	195	186MH.....	282
149MUL-2.....	186	160ALD.....	281	172VG-3.....	257	186MP.....	282
149MUL-3.....	194	160C.....	281	173FJ.....	136	186MUL.....	192
149MUL-4.....	198	160FJ.....	131	173MUL.....	195	186P.....	281
14BB.....	6	160KA.....	281	174MUL.....	196	186SP.....	105
14BB-O.....	6	160MH.....	281	174P.....	285	187BB.....	7
150-O.....	278	160MP.....	281	175-O.....	284	187BB-O.....	7
150ALD.....	278	160MUL.....	190	175C.....	284	187MUL.....	199
150C.....	278	160P.....	281	175MH.....	284	189MUL.....	196
150FJ.....	128	161-O.....	281	175MP.....	284	18BB.....	6
150MH.....	278	161FJ.....	132	175MUL.....	196	18PB.....	345
150MP.....	278	161MUL.....	191	176-O.....	281	18PB.....	254



Part Number Index

190ALD.....	286	2003LDF.....	251	307-O.....	289	321SP-3.....	110
190BB.....	7	2003SP.....	122	307BSP.....	109	323-O.....	293
190BB-O.....	7	2005LDF.....	251	307FJ.....	141	323C.....	293
190KA.....	286	2005MUL.....	251	307MUL.....	202	323FJ.....	146
190MUL.....	199	2007LDF.....	251	307SP.....	109	323MH.....	293
190P.....	286	2008LDF.....	251	30MDF-F.....	254, 346	323MP.....	293
190SP.....	101	2009LDF.....	251	310-O.....	288	323MUL.....	208
191BB.....	7	200SP.....	106	310BFJ.....	138	323P.....	293
191BB-O.....	7	201C.....	288	310BMUL.....	201	324-O.....	290
191MUL.....	193	201LDF.....	200	310FJ.....	138	324ALD.....	290
191P.....	286	201MUL.....	200	310MUL.....	201	324C.....	290
192BB.....	6	201P.....	288	311-O.....	289	324FJ.....	142
192BB-O.....	6	201SP.....	106	311ALD-3.....	289	324MH.....	290
192MUL.....	190	201VG.....	259	311BMUL.....	203	324MP.....	290
193BB.....	6	202MUL.....	200	311FJ.....	141	324MUL.....	203
193BB-O.....	6	202SP.....	106	311LDF-3N.....	201	324P.....	290
193MUL.....	196	203MUL.....	200	311LDF-4.....	205	325ALD.....	292
194BB.....	7	203SP.....	106	311MH-3.....	289	325C.....	292
194BB-O.....	7	204MUL.....	200	311MUL.....	203	325FJ.....	144
194BBALD.....	7	204SP.....	106	311MUL-4.....	205	325MH.....	292
194BBMDF.....	7	205SP.....	106	311P-3.....	289	325MP.....	292
194BBMP.....	7	206SP.....	106	311P-4.....	291	325MUL.....	206
194MUL.....	186	207SP.....	106	313MUL.....	204	325P.....	292
195BB.....	7	208SP.....	106	314-O4.....	290	326-O.....	291
195BB-O.....	7	209VG.....	259	314ALD-4.....	290	326FJ.....	144
195BBALD.....	7	210BSP.....	106	314MUL-3.....	201	326MUL.....	205
195BBMDF.....	7	210MUL.....	200	314MUL-3SC.....	201	326P.....	291
195BBMP.....	7	210SP.....	106	314MUL-4.....	205	327MUL-4.....	206
195MUL.....	186	212SP.....	106	314MUL-5.....	209	327MUL-5.....	210
196BB.....	7	213SP.....	106	314MUL-5SC.....	209	328FJ-5.....	148
196BB-O.....	7	214SP.....	106	314MUL-7.....	218	328MUL-5.....	210
196BBALD.....	7	216SP.....	106	314P-4.....	290	328MUL-6.....	216
196BBMDF.....	7	217SP.....	106	314SP-3.....	109	329ALD.....	290
196BBMP.....	7	218SP.....	106	314SP-5.....	111	329C.....	290
196MUL.....	186	219SP.....	106	314VG-3.....	260	329KA.....	290
197BB.....	7	21BB.....	7	316-O.....	291	329MH.....	290
197BB-O.....	7	21BB-O.....	7	316FJ.....	143	329MP.....	290
197BBALD.....	7	22BB.....	7	317FJ.....	147	329MUL.....	204
197BBMFD.....	7	22BB-O.....	7	317MUL.....	209	330BMUL.....	208
197BBMP.....	7	23BB.....	7	318-O4.....	290	330BP.....	293
197MUL.....	188	23BB-O.....	7	318-O5.....	293	330MUL.....	208
198BB.....	7	24PB-BN.....	254, 345	318ALD-4.....	290	331MUL.....	222
198BB-O.....	7	2BBMDF.....	6	318BFJ.....	148	332MUL.....	215
198BBALD.....	7	300A-O.....	288	318BMUL.....	209	332P.....	296
198BBMDF.....	7	300AFJ.....	138	318C-4.....	290	333MUL.....	218
198BBMP.....	7	300ASP.....	107	318FJ-4.....	143	333P-4.....	292
198MUL.....	188	300B-O.....	288	318MH-4.....	290	333P-7.....	297
199ALD.....	285	300BALD.....	288	318MP-4.....	290	334BMUL.....	217
199KA.....	285	300BC.....	288	318MUL-4.....	204	334MUL.....	217
1BBMDF.....	6	300BMH.....	288	318MUL-5.....	210	335MUL.....	203
1x4BS.....	95	300BMP.....	288	318P-4.....	290	338-O3.....	289
1x6NGS.....	95	300BP.....	288	318P-5.....	293	338-O4.....	292
2000FJ.....	179	300BSP.....	107	318SP-5.....	111	338ALD-4.....	292
2000LDF.....	251	300BVG.....	259	319FJ.....	139	338C-4.....	292
2000SP.....	122	301FJ.....	138, 175	319MUL.....	201	338MH-4.....	292
2001FJ.....	179	304FJ.....	138	320MUL.....	201	338MH-5.....	295
2001LDF.....	251	304MUL.....	201	321FJ-2.....	139	338MP-4.....	292
2001SP.....	122	305FJ.....	138	321FJ-3.....	142	338MP-5.....	295
2002LDF.....	251	306-O.....	288	321FJ-4.....	145	338MUL-3.....	203
2002SP.....	122	306BSP.....	107	321MUL-3.....	203	338MUL-4.....	206
2003ALD.....	321	306SP.....	107	321MUL-4.....	204	338MUL-5.....	211



Part Number Index

338MUL-9	224	365MUL	213	3916FI8	270	410MP-6	306
338P-3	289	365P-5	295	3916FIL	270	410MP-8	312
338P-4	292	365P-7	298	3916I6	182	410MUL-4	229
338P-7	298	366MUL	202	3916I6K2	182	410MUL-5	232
339FJ	140	367FJ	142	3916I8	182	410MUL-6	236
339MUL	203	368MUL	213	3916I8K2	182	410MUL-8	245
340ALD	298	36BB	6	3916IL	182	410P-6	306
340MUL	218	36BBALD	6	3916KAI6	332	410P-8	312
340P	298	36BBC	6	3916KAI8	332	411MUL-4	231
341MUL	211	36BBMDF	6	3916KAIL	332	411MUL-5	233
342ALD-6	297	36BBMP	6	392MUL-4	207	411MUL-6	238
342C-6	297	36BBP	6	392MUL-5	215	412FGE6	270
342KA-6	297	372MUL-5	214	39BB	6	412FGE8	270
342MH-6	297	372MUL-7	221	39BBALD	6	412FGL	270
342MP-6	297	375MUL	216	39BBC	6	412L	181
342MUL-6	215	375VG-7	261	39BBMDF	6	412MUL	230
342MUL-7	218	379MUL	221	39BBMP	6	412O6	332
342MUL-8	222	37BB	6	39BBP	6	412O8	332
342P-6	297	37BBALD	6	3BB-O	6	412OL	332
343MUL	219	37BBC	6	3BBMDF	6	412SD6	182
345MUL	219	37BBMDF	6	3CL	347	412SD8	182
349MUL-4	207	37BBMP	6	400SP	112	412SDL	182
349MUL-5	211	37BBP	6	401SP-1	112	412W6	181
349MUL-7	219	380MUL	222	402MUL	226	412W8	181
350MUL	211	381K	99	404MUL	226	412WL	181
351MUL	202	381MUL	223	405-O	300	412WOL	332
352MUL	212	382MUL	223	405ALD	300	414LDF	234
352MUL-SC	212	385-O	297	405B-O	300	414MUL	234
353MUL	220	385ALD	297	405BP	300	414SP	114
354MUL	214	385C	297	405BSP	112	415MUL	242
355MUL	212	385MH	297	405C	300	416MUL	239
358MUL	220	385MP	297	405KA	300	416P	308
359MUL	214	385MUL	216	405MH	300	417ALD	311
359P	294	385P	297	405MP	300	417B-O	311
35BB	6	387-O4	292	405MUL	226	417BALD	311
35BBALD	6	387ALD-4	292	405P	300	417BC	311
35BBC	6	387C-4	292	405SP	112	417BMH	311
35BBMDF	6	387KA-5	295	406MUL	228	417BMP	311
35BBMP	6	387MH-4	292	406P	301	417MUL	243
35BBP	6	387MP-4	292	406SP	113	417P	311
360MUL	220	387MUL	221	407MUL	229	418C6	332
361-O5	294	387MUL-3	203	408FJ	164	418C8	332
361-O7	298	387MUL-4	207	408MUL-4	231	418CL	332
361ALD-5	294	387MUL-5	215	408MUL-6	236	418FGE6	270
361ALD-7	298	387P-4	292	409-O	302	418FGE8	270
361C-5	294	387SP-5	111	409MUL	230	418FGL	270
361C-7	298	389MUL	217	40BB	6	418L	181
361KA-5	294	38BB	6	40BB-O	6	418M6	332
361MH-5	294	38BB-O	6	40BBALD	6	418M8	332
361MH-7	298	38BBALD	6	40BBC	6	418ML	332
361MP-5	294	38BBC	6	40BBMDF	6	418O6	332
361MP-7	298	38BBMDF	6	40BBMP	6	418O8	332
361MUL-3	202	38BBMP	6	40BBP	6	418OL	332
361MUL-4	207	38BBP	6	410-O6	306	418P6	332
361MUL-5	212	390MUL	208	410ALD-6	306	418P8	332
361MUL-7	221	3916ALDI6	332	410C-6	306	418PL	332
361MUL-9	224	3916ALDI8	332	410C-8	312	418SD6	182
361P-5	294	3916ALDIL	332	410FJ-6	164	418SD8	182
361P-7	298	3916CI6	332	410KA-6	306	418SDL	182
362MUL-4	205	3916CI8	332	410MH-6	306	418SP	112
362MUL-5	213	3916FI6	270	410MH-8	312	418SP6	124



Part Number Index

418SP8.....	124	427ALD.....	308	436MP.....	299	458P8.....	332
418VGE6.....	270	427C.....	308	436MUL.....	226	458PL.....	332
418VGE8.....	270	427MH.....	308	436P.....	299	458SA6.....	332
418VGL.....	270	427MP.....	308	436SP.....	112	458SA8.....	332
418W6.....	181	427MUL.....	240	437MUL.....	241	458SP6.....	124
418W8.....	181	427P.....	308	437P.....	312	458SP8.....	124
418WC6.....	332	428MUL.....	244	438MUL.....	225	458VGE6.....	270
418WC8.....	332	429MUL.....	248	439MUL.....	225	458VGE8.....	270
418WCL.....	332	42BB.....	6	43BB.....	6	458VGL.....	270
418WFGE6.....	270	42BB-O.....	6	43BB-O.....	6	458W6.....	181
418WFGE8.....	270	42BBALD.....	6	43BBALD.....	6	458W8.....	181
418WFGL.....	270	42BBC.....	6	43BBC.....	6	458WC6.....	332
418WL.....	181	42BBMDF.....	6	43BBMDF.....	6	458WC8.....	332
418WM6.....	332	42BBMP.....	6	43BBMP.....	6	458WCL.....	332
418WM8.....	332	42BBP.....	6	43BBP.....	6	458WFGE6.....	270
418WML.....	332	432MUL.....	245	440MUL.....	225	458WFGE8.....	270
418WO6.....	332	433MUL.....	241	441MUL.....	227	458WKA6.....	332
418WO8.....	332	434ALDI6.....	332	441P.....	300	458WKA8.....	332
418WOL.....	332	434ALDI8.....	332	442MUL.....	232	458WL.....	181
418WP6.....	332	434ALDIL.....	332	442P.....	302	458WM6.....	332
418WP8.....	332	434ALDIL.....	332	443MUL.....	240	458WM8.....	332
418WPL.....	332	434CI6.....	332	443P.....	307	458WML.....	332
418WSP6.....	124	434CI8.....	332	444MUL-3.....	227	458WO6.....	332
418WSP8.....	124	434CIL.....	332	444MUL-4.....	231	458WO8.....	332
418WVGE6.....	270	434EL.....	181	444MUL-5.....	235	458WOL.....	332
418WVGE8.....	270	434FGE6.....	270	444MUL-7.....	243	458WP6.....	332
418WVGL.....	270	434FGE8.....	270	446MUL.....	228	458WP8.....	332
419MUL.....	225	434FGL.....	270	447MUL.....	240	458WPL.....	332
41BB.....	6	434FI6.....	270	448MUL.....	238	458WSA6.....	332
41BB-O.....	6	434FI8.....	270	449MUL.....	247	458WSA8.....	332
41BBALD.....	6	434FIL.....	270	44BB.....	6	458WSP6.....	124
41BBC.....	6	434I6.....	182	44BB-O.....	6	458WSP8.....	124
41BBMDF.....	6	434I8.....	182	44BBALD.....	6	458WVGE6.....	270
41BBMP.....	6	434I8.....	182	44BBC.....	6	458WVGE8.....	270
41BBP.....	6	434I8.....	182	44BBMDF.....	6	458WVGL.....	270
420MUL.....	226	434I8.....	182	44BBMP.....	6	460MUL-2.....	226
421MUL.....	227	434KAI6.....	332	44BBP.....	6	460MUL-4.....	230
421P.....	300	434KAI8.....	332	451MUL.....	228	460MUL-5.....	233
422MUL.....	230	434KAIL.....	332	453MUL.....	236	462MUL-2.....	226
423ALD.....	303	434MHI8.....	332	454MUL.....	246	462MUL-4.....	231
423BMUL.....	232	434MI6.....	255	455LDF.....	233	462MUL-6.....	237
423C.....	303	434MI8.....	255	456P.....	309	462VG.....	263
423KA.....	303	434MIL.....	255	458ALDI6.....	332	465LDF-5.....	233
423MH.....	303	434MUL.....	229	458ALDI8.....	332	465LDF-7.....	244
423MP.....	303	434O16.....	332	458ALDIL.....	332	467MUL.....	229
423MUL.....	232	434O18.....	332	458C6.....	332	469MUL.....	232
423P.....	303	434OIL.....	332	458C8.....	332	478ALDI6.....	332
424-O6.....	309	434PI6.....	332	458CL.....	332	478ALDI8.....	332
424ALD-6.....	309	434PI8.....	332	458DFGL.....	270	478ALDIL.....	332
424C-6.....	309	434PIL.....	332	458DR6.....	180	478I6.....	182
424KA-6.....	309	434PV16.....	124	458DRL.....	180	478I8.....	182
424LDF-7.....	242	434SD6.....	182	458KA6.....	332	478IL.....	182
424MH-6.....	309	434SD8.....	182	458KA8.....	332	49-O.....	329
424MP-6.....	309	434SDL.....	182	458L.....	181	4916ALDI6.....	332
424MUL-6.....	239	434SPI6.....	124	458M6.....	332	4916ALDI8.....	332
424MUL-7.....	242	434SPI8.....	124	458M8.....	332	4916ALDIL.....	332
424P-6.....	309	434W6.....	181	458ML.....	332	4916CI6.....	332
425MUL-3.....	228	434W8.....	181	458O6.....	332	4916CI8.....	332
425MUL-5.....	235	434WL.....	181	458O8.....	332	4916CIL.....	332
426MUL.....	227	435MUL.....	237	458OL.....	332	4916FI6.....	270
427-O.....	308	436-O.....	299	458P6.....	332	4916FI8.....	270
		436ALD.....	299				
		436C.....	299				
		436MH.....	299				



Part Number Index

4916FIL.....	270	514FGE8.....	270	514WP6.....	332	593ALD.....	314
4916I6.....	182	514FGL.....	270	514WP8.....	332	593C.....	314
4916I8.....	182	514FI6.....	270	514WPL.....	332	593MH.....	314
4916IL.....	182	514FI8.....	270	514WSA6.....	332	593MP.....	314
4916KAI6.....	332	514FIL.....	270	514WSA8.....	332	593P.....	314
4916KAI8.....	332	514I6.....	182	514WSP6.....	124	593SP.....	117
4916KAIL.....	332	514I8.....	182	514WSP8.....	124	594-O.....	314
4916MI6.....	255	514IL.....	182	514WVGE6.....	270	594ALD.....	314
4916MI8.....	255	514KAE6.....	332	514WVGE8.....	270	594C.....	314
4916MIL.....	255	514KAE8.....	332	514WVGL.....	270	594MH.....	314
4916OI6.....	332	514KAI6.....	332	520SP.....	116	594MP.....	314
4916OI8.....	332	514KAI8.....	332	521-O.....	314	594P.....	314
4916OIL.....	332	514KAIL.....	332	521ALD.....	314	594SP.....	117
4916PI6.....	332	514ME6.....	332	521C.....	314	597SP.....	117
4916PI8.....	332	514ME8.....	332	521MH.....	314	598P.....	314
4916PIL.....	332	514MEL.....	332	521MP.....	314	599VG.....	264
4916PVI6.....	124	514MHI8.....	332	521P.....	314	5ALDS.....	328
4916PVI8.....	124	514MI6.....	255	521SP.....	116	5BBMDF.....	6
4916SPI6.....	124	514MI8.....	255	522SP.....	116	5CS.....	328
4916SPI8.....	124	514MIL.....	255	523-O.....	314	5MHS.....	328
4BBMDF.....	6	514OE6.....	332	523ALD.....	314	5WLS.....	328
4CL.....	347	514OE8.....	332	523C.....	314	600-O.....	315
50-O.....	329	514OEL.....	332	523MH.....	314	600SP.....	119
500SP.....	116	514OI6.....	332	523MP.....	314	601-O.....	315
501SP.....	116	514OI8.....	332	523P.....	314	601SP.....	119
502-O.....	314	514OIL.....	332	523R.....	271	602-O.....	315
502C.....	314	514PE6.....	332	523SP.....	116	602ALD.....	315
502MH.....	314	514PE8.....	332	523VG.....	264	602SP.....	119
502MP.....	314	514PEL.....	332	524SP.....	116	605-O.....	315
502P.....	314	514PI6.....	332	525BSP.....	116	605ALD.....	315
502SP.....	116	514PI8.....	332	525SP.....	116	605SP.....	119
503SP.....	116	514PIL.....	332	526SP.....	116	606-O.....	315
504-O.....	314	514PV16.....	124	527BSP.....	116	606SP.....	119
504ALD.....	314	514SAE6.....	332	527SP.....	116	608-O.....	315
504C.....	314	514SAE8.....	332	528SP.....	116	611P.....	318
504MH.....	314	514SD6.....	182	570SP.....	116	612-O.....	315
504MP.....	314	514SD8.....	182	571SP.....	116	612ALD.....	315
504P.....	314	514SDL.....	182	572-O.....	314	612ASP.....	121
504R.....	271	514SPE6.....	124	572C.....	314	612AVG.....	269
504SP.....	116	514SPE8.....	124	572MH.....	314	612BALD.....	323
504VG.....	264	514SPI6.....	124	572MP.....	314	612BC.....	323
505SP.....	116	514SPI8.....	124	572P.....	314	612BMH.....	323
50S.....	328	514VGE6.....	270	572SP.....	116	612BSP.....	121
512I6.....	182	514VGE8.....	270	573SP.....	116	612BVG.....	269
512I8.....	182	514VGL.....	270	574SP.....	116	612C.....	315
512W6.....	181	514W8.....	181	575P.....	314	612MH.....	315
512W8.....	181	514WC6.....	332	576P.....	314	612MP.....	315
514ALDI6.....	332	514WC8.....	332	580-O.....	314	612P.....	315
514ALDI8.....	332	514WCL.....	332	580MP.....	314	613-O.....	316
514ALDIL.....	332	514WFG6.....	270	581-O.....	314	613P.....	316
514CE6.....	332	514WFG8.....	270	581MP.....	314	613SP.....	119
514CE8.....	332	514WFG.....	270	582-O.....	314	614-O.....	316
514CEL.....	332	514WKA6.....	332	582MP.....	314	614ALD.....	316
514CI6.....	332	514WKA8.....	332	583-O.....	314	614C.....	316
514CI8.....	332	514WL.....	181	583MP.....	314	614MH.....	316
514CIL.....	332	514WM6.....	332	590SP.....	117	614MP.....	316
514DR6.....	180	514WM8.....	332	591-O.....	314	614P.....	316
514DRL.....	180	514WML.....	332	591P.....	314	614SP.....	107, 119
514EL.....	181	514WO6.....	332	591SP.....	117	615P.....	317
514EW6.....	181	514WO8.....	332	592SP.....	117	615SP.....	107, 119
514FGE6.....	270	514WOL.....	332	593-O.....	314	616P.....	316



Part Number Index

617P.....	317	632P.....	316	660MUL.....	250	712I8.....	182
618FGE6.....	270	635-O.....	315	660P.....	322	712SP.....	121
618FGE8.....	270	635P.....	315	660SP.....	118	712W6.....	181
618FGL.....	270	638.....	97	660VG.....	265	712W8.....	181
618L.....	181	646-O.....	322	661-O.....	322	712WL.....	181
618SD6.....	182	646ALD.....	322	661ALD.....	322	713-O.....	331
618SD8.....	182	646C.....	322	661C.....	322	713LDF.....	253
618SDL.....	182	646MUL.....	250	661MH.....	322	713MH.....	331
618W6.....	181	646P.....	322	661P.....	322	713MUL.....	253
618W8.....	181	646SP.....	118	661VG.....	265	713P.....	331
618WFGE6.....	270	646VG.....	265	662-O.....	322	713R.....	271
618WFGE8.....	270	647MUL.....	249	662ALD.....	322	713SP.....	121
618WFGL.....	270	648-O.....	319	662C.....	322	713VG.....	266
618WL.....	181	648MUL.....	249	662SP.....	118	714-O.....	331
619P.....	318	648P.....	319	662VG.....	265	714ALDI6.....	332
620-O.....	317	649MUL.....	249	663-O.....	322	714ALDI8.....	332
620ALD.....	317	651-O.....	319	663ALD.....	322	714ALDIL.....	332
620C.....	317	651MUL.....	249	663B-O.....	322	714C.....	331
620MH.....	317	653-O.....	319	663BALD.....	322	714CE6.....	332
620MP.....	317	653C.....	319	663BMH.....	322	714CE8.....	332
620P.....	317	653MH.....	319	663BP.....	322	714CEL.....	332
620SP.....	118	653MP.....	319	663BVG.....	265	714CI6.....	332
620VG.....	264	653MUL.....	249	663C.....	322	714CI8.....	332
621-O.....	317	653P.....	319	663MH.....	322	714CIL.....	332
621ALD.....	317	654P.....	320	663P.....	322	714EL.....	181
621C.....	317	655-O.....	319	663VG.....	265	714EW6.....	181
621MH.....	317	655MUL.....	249	664VG.....	265	714FGE6.....	270
621MP.....	317	655P.....	319	667MH.....	322	714FGE8.....	270
621P.....	317	656MUL.....	249	667P.....	322	714FGL.....	270
622ALD.....	318	656P.....	320	667QWO.....	322	714FI6.....	270
622P.....	318	658-O.....	319	667VG.....	265	714FI8.....	270
623P.....	316	658C6.....	332	667WL.....	322	714FIL.....	270
623SP.....	118	658C8.....	332	680P.....	314	714I6.....	182
623VG.....	264	658DR6.....	180	6916I6.....	182	714I8.....	182
624-O.....	315	658DRL.....	180	6916I8.....	182	714IL.....	182
624SP.....	118	658FGE6.....	270	6916IL.....	182	714KAE6.....	332
625P.....	316	658FGE8.....	270	6916MI6.....	255	714KAE8.....	332
625SP.....	118	658FGL.....	270	6916MI8.....	255	714KAI6.....	332
628-O.....	316	658L.....	181	6916MIL.....	255	714KAI8.....	332
628C.....	316	658SP6.....	124	6916PV16.....	124	714KAIL.....	332
628MH.....	316	658SP8.....	124	693P.....	320	714LDF.....	253
628MP.....	316	658VGE6.....	270	6BB.....	6	714ME6.....	332
628P.....	316	658VGE8.....	270	6BB-O.....	6	714ME8.....	332
629P.....	315	658VGL.....	270	700SP.....	121	714MEL.....	332
630-O.....	315	658W6.....	181	701BSP.....	121	714MH.....	331
630ALD.....	315	658W8.....	181	701SP.....	121	714MHI8.....	332
630C.....	315	658WC6.....	332	702BSP.....	121	714MI6.....	255
630MH.....	315	658WC8.....	332	702SP.....	121	714MI8.....	255
630MP.....	315	658WL.....	181	703BSP.....	121	714MIL.....	255
630P.....	315	658WSP6.....	124	703SP.....	121	714MP.....	331
631-O.....	315	658WSP8.....	124	704SP.....	121	714MUL.....	253
631ALD.....	315	658WVGE6.....	270	705SP.....	121	714OE6.....	332
631C.....	315	658WVGE8.....	270	706SP.....	121	714OE8.....	332
631MH.....	315	658WVGL.....	270	707SP.....	121	714OEL.....	332
631MP.....	315	659-O.....	319	708SP.....	121	714OI6.....	332
631P.....	315	659P.....	319	709SP.....	121	714OI8.....	332
632-O.....	316	660-O.....	322	70S.....	328	714OIL.....	332
632ALD.....	316	660ALD.....	322	710SP.....	121	714P.....	331
632C.....	316	660C.....	322	711R.....	271	714PE6.....	332
632MH.....	316	660MH.....	322	711SP.....	121	714PE8.....	332
632MP.....	316	660MP.....	322	712I6.....	182	714PEL.....	332



Part Number Index

714PI6.....	332	720-O.....	323	752C.....	331	833R.....	272
714PI8.....	332	720SP.....	120	752KP.....	121	833RFJ.....	272
714PIL.....	332	721-O.....	323	752LDF.....	253	833VG.....	269
714PV16.....	124	721ALD.....	323	752MH.....	331	841R.....	273
714SAE6.....	332	721C.....	323	752MP.....	331	850-0.....	327
714SAE8.....	332	721MH.....	323	752MUL.....	253	850-O3.....	327
714SD6.....	182	721MP.....	323	752P.....	331	851-0.....	327
714SD8.....	182	721P.....	323	752SP.....	121	851-03.....	327
714SDL.....	182	721SP.....	120	752VG.....	266	854-0.....	327
714SP.....	121	722R.....	271	753-O.....	331	854-03.....	327
714SPE6.....	124	722SP.....	120	753C.....	331	858-0.....	327
714SPE8.....	124	723-O.....	323	753FJ.....	178	859-0.....	327
714SPI6.....	124	723C.....	323	753KA.....	331	860-0.....	327
714SPI8.....	124	723MH.....	323	753KP.....	121	890VG.....	266
714VG.....	266	723MP.....	323	753LDF.....	253	892-O.....	331
714VGE6.....	270	723P.....	323	753MH.....	331	892C.....	331
714VGE8.....	270	723SP.....	120	753MP.....	331	892MP.....	331
714VGL.....	270	725VG.....	266	753MUL.....	253	893-O.....	331
714W8.....	181	729BP.....	318	753P.....	331	893C.....	331
714WC6.....	332	729LDF.....	250	753SP.....	121	893MP.....	331
714WC8.....	332	730-O.....	316	753VG.....	266	894-O.....	331
714WCL.....	332	732-O.....	316	754KA.....	331	894C.....	331
714WFGE6.....	270	733MUL.....	250	755VG.....	266	894MP.....	331
714WFGE8.....	270	734MUL.....	250	756KA.....	331	899-O.....	331
714WFG.....	270	735MUL.....	202	756VG.....	266	899C.....	331
714WKA6.....	332	736ALD.....	321	757VG.....	266	899MP.....	331
714WKA8.....	332	736MUL.....	202	758KP.....	121	8BB.....	6
714WL.....	181	737MUL.....	250	758VG.....	266	8BB-O.....	6
714WM6.....	332	738MUL.....	250	759VG.....	266	8FOS.....	328
714WM8.....	332	739MUL.....	250	7ALDS.....	328	8OS.....	328
714WML.....	332	739R.....	273	7BB.....	6	8RS.....	274
714WO6.....	332	740LDF.....	250	7BB-O.....	6	8RSD.....	274
714WO8.....	332	742R.....	271	7CS.....	328	8RVS.....	274
714WOL.....	332	750-O.....	331	7MHS.....	328	900SP.....	123
714WP6.....	332	750ALD.....	331	7WLS.....	328	901SP.....	123
714WP8.....	332	750C.....	331	800SP.....	121	903SP.....	123
714WPL.....	332	750FJ.....	178	801BG.....	95	904SP.....	123
714WSA6.....	332	750KA.....	331	801SP.....	121	905SP.....	123
714WSA8.....	332	750KP.....	121	802BG.....	95	906SP.....	123
714WSP6.....	124	750LDF.....	253	802FJ.....	346	907SP.....	123
714WSP8.....	124	750MH.....	331	802SP.....	346	908SP.....	123
714WVGE6.....	270	750MP.....	331	802SP.....	121	909-O.....	329
714WVGE8.....	270	750MUL.....	253	803-O.....	314	909ALD.....	329
714WVGL.....	270	750P.....	331	803SP.....	121, 346	909P.....	329
715-O.....	331	750SP.....	121	807SP.....	121	909SP.....	123
715ALD.....	331	750VG.....	266	819R.....	271	90CSP.....	8
715C.....	331	751-O.....	331	820R.....	271	90DP.....	8
715FJ.....	178	751ALD.....	331	821R.....	271	910-O.....	329
715KA.....	331	751C.....	331	822R.....	271	910P.....	329
715KP.....	121	751FJ.....	178	823R.....	271	911SP.....	123
715LDF.....	253	751KA.....	331	825R.....	272	912-O.....	330
715MH.....	331	751KP.....	121	826AR.....	272	912SP.....	123
715MP.....	331	751LDF.....	253	826R.....	272	913-O.....	330
715MUL.....	253	751MH.....	331	827R.....	273	914KA16.....	332
715P.....	331	751MP.....	331	827WR.....	273	914KA18.....	332
715SP.....	121	751MUL.....	253	828TP.....	274	914KAIL.....	332
715VG.....	266	751P.....	331	830R.....	271	914WKA6.....	332
716SP.....	121	751SP.....	121	833-O.....	323	914WKA8.....	332
717SP.....	121	751VG.....	266	833ALD.....	323	916SP.....	123
717VG.....	266	752-O.....	331	833C.....	323	91CSP.....	8
719SP.....	121	752ALD.....	331	833MH.....	323	91DP.....	8



Part Number Index

925-O.....	324	995P.....	330	CM73-O.....	305	CR63A.....	333
925-OPL.....	324	996LDF.....	253	CM73ALD.....	305	CR64.....	333
928-O.....	325	998MUL.....	200	CM73C.....	305	CR65.....	333
928-OPL.....	325	998P.....	330	CM73MH.....	305	CR66.....	333
92DP.....	8	999LDF.....	252	CM73MP.....	305	CR67.....	333
931P.....	325	9BB.....	6	CM73P.....	305	CR68.....	333
931PPL.....	325	9BB-O.....	6	CM74-O.....	301	CR69.....	333
932P.....	324	BA42.....	333	CM74ALD.....	301	CR70.....	333
932PPL.....	324	BA43C.....	333	CM74C.....	301	CR72.....	333
933P.....	326	BA44.....	333	CM74MH.....	301	CR800P.....	310
933PPL.....	326	BA46.....	333	CM74MP.....	301	CR806P.....	304
93DP.....	8	BA47.....	333	CM74P.....	301	CR810P.....	303
94DP.....	8	BA48.....	333	CM74SF.....	90	CR820P.....	301
950-O.....	324	BA8440.....	338	CM75.....	334	CR830P.....	305
950P.....	324	BA8442.....	338	CM76.....	334	CR841P.....	307
951-O.....	324	BA8444.....	338	CM77.....	334	CR862-O.....	310
951P.....	324	BB15.....	333	CM80.....	334	CR862P.....	310
951R.....	275	BB17.....	333	CM81.....	334	CR864P.....	303
953FJ.....	177	BB8108.....	338	CM82.....	334	CR880P.....	306
953RFJ.....	272	BB8109.....	338	CM83.....	334	CRO.....	347
953VG.....	269	BB8110.....	338	CM84.....	334	CRO-NO.....	347
954FJ.....	177	BB8111.....	338	CM85.....	334	CRR.....	347
955R.....	275	BB8122.....	338	CM86.....	334	DE168P.....	313
956-O.....	326	CA30.....	333	CM87.....	334	DE169P.....	313
95DP.....	8	CA31.....	333	CM8780.....	339	DE170P.....	313
95MSP.....	8	CA326-O.....	282	CM8782.....	339	DE171-O.....	313
96DP.....	8	CA326P.....	282	CM8783.....	339	DE171P.....	313
96MSP.....	8	CA327P.....	285	CM88.....	334	DE73P.....	235, 313
970ALD.....	277	CA36.....	333	CM8801.....	339	DE74P.....	235, 313
970LDF.....	185	CA364P.....	284	CM8808.....	339	DH190-O.....	287
976LDF.....	252	CA37.....	333	CM8810.....	339	DH190P.....	287
977LDF.....	252	CA38.....	333	CM8812.....	339	DH99.....	333
978P.....	330	CA39.....	333	CM8820.....	339	EB1.....	347
978VG.....	266	CA40.....	333	CM8823.....	339	EB2.....	347
979FJ.....	175	CA41.....	333	CM8825.....	339	F800.....	269
979SP.....	122	CA8320.....	338	CM8830.....	339	F801.....	269
980FJ.....	175	CA8322.....	338	CM8834.....	339	F802.....	269, 346
980SP.....	122	CA8326.....	338	CM8837.....	339	F802FJ.....	269, 346
981SP.....	122	CA8330.....	338	CM8840.....	339	F803.....	269, 346
982SP.....	122	CA8336.....	338	CM8853.....	339	F804.....	269
984SP.....	122	CA8338.....	338	CM8854.....	339	F804FJ.....	269
985FJ.....	175	CA8340.....	338	CM8856.....	339	F805.....	269
985SP.....	122	CA8342.....	338	CM8857.....	339	F806.....	269
986LDF.....	252	CA8344.....	338	CM8858.....	339	F925.....	268
987LDF.....	252	CA8347.....	338	CM8859.....	339	F925PL.....	268
990FJ.....	175	CA8348.....	338	CM8860.....	339	F926.....	267
990LDF.....	252	CH.....	346	CM8862.....	339	F926PL.....	267
990SP.....	122	CM15BM.....	90	CM89.....	334	F927.....	268
991LDF.....	252	CM16FL.....	90	CM90.....	334	F927PL.....	268
992-O.....	330	CM16FL2.....	91	CM93.....	334	F928.....	268
992FJ.....	175	CM16JE2.....	91	CM94.....	334	F928PL.....	268
992LDF.....	252	CM24RN.....	91	CM95.....	334	F932.....	267
992P.....	330	CM30AL.....	91	CM96.....	334	F932PL.....	267
992SP.....	122	CM32RO2.....	91	CO705P.....	304	F951FJ.....	267
993FJ.....	175	CM32SG.....	91	COR5X10.....	88	F955.....	267
993LDF.....	252	CM36NI.....	90	CPO.....	346	F956.....	267
994-O.....	330	CM38SY.....	90	CPR.....	346	F956FJ.....	267
994FJ.....	175	CM67WT.....	90	CPS-0.....	347	FL1X4VG.....	266
994LDF.....	252	CM70.....	334	CR13.....	343	FLV16X24.....	88
994P.....	330	CM71.....	334	CR14.....	343	FR15.....	343
995LDF.....	252	CM72.....	334	CR61.....	333	FR458W.....	181



Part Number Index

FR458W8.....	181	HR619-O.....	331	OBC-O.....	7	PF714W6.....	351
FR626-O.....	331	HR619ALD.....	331	P802FJ.....	346	PF714W8.....	351
FR626C.....	331	HR619C.....	331	PAK1x4BW.....	100	PF8FAST8.....	352
FR626P.....	331	HR619MP.....	331	PAK1x6BW.....	100	PFBKM6.....	352
FR627-O.....	331	HR619P.....	331	PAK1x6LAP.....	100	PFBKM8.....	352
FR627C.....	331	HR620-O.....	331	PB1.....	5	PFBKMK.....	352
FR627P.....	331	HR620ALD.....	331	PB1-O.....	5	PFSM.....	352
FR714W.....	181	HR620C.....	331	PB10.....	5	PIL6X108.....	88
FR8920.....	340	HR620MP.....	331	PB10-O.....	5	PIL8108.....	88
FR8921.....	340	HR620P.....	331	PB11.....	5	PM07.....	335
FR8922.....	340	HR621-O.....	331	PB11-O.....	5	PM08.....	335
FR8923.....	340	HR621ALD.....	331	PB2.....	5	PM09.....	335
FR8940.....	340	HR621C.....	331	PB2-O.....	5	PM10.....	335
FR8950.....	340	HR621MP.....	331	PB20.....	5	PM11.....	335
FR8953.....	340	HR621P.....	331	PB20-O.....	5	PM12.....	335
FR8954.....	340	HR622-O.....	331	PB20ALD.....	5	PM14.....	335
FR8955.....	340	HR622ALD.....	331	PB20C.....	5	PM16.....	335, 343
FR8956.....	340	HR622C.....	331	PB20MDF.....	5	PM20.....	335
FR8957.....	340	HR622MP.....	331	PB20MP.....	5	PM22.....	335
FR8958.....	340	HR622P.....	331	PB21.....	5	PM22PL.....	335
FR8960.....	340	HR623-O.....	331	PB21-O.....	5	PM23B.....	335
FR8965.....	340	HR623ALD.....	331	PB21ALD.....	5	PM24.....	335
FR8967.....	340	HR623C.....	331	PB21C.....	5	PM25.....	335
FR8968.....	343	HR623MP.....	331	PB21MDF.....	5	PM27.....	335
FR8970.....	343	HR623P.....	331	PB21MP.....	5	PM50.....	335
FR8971.....	343	HR624-O.....	331	PB22.....	5	PM52.....	335
FR8980.....	343	HR624ALD.....	331	PB22-O.....	5	PM54.....	335
FR8982.....	343	HR624C.....	331	PB22ALD.....	5	PM55.....	335
FRLV16.....	88	HR624MP.....	331	PB22C.....	5	PM56B.....	335
FRLV18.....	88	HR624P.....	331	PB22MDF.....	5	PM57.....	335
FRLV22.....	88	IBC.....	7	PB22MP.....	5	PM58.....	335
FRLV24.....	88	IBC-O.....	7	PB23.....	5	PM59.....	335
FRLV24TK.....	88	JAMBEXT.....	124	PB23-O.....	5	PM595.....	335
FRPR418W6.....	181	LM90.....	336	PB23ALD.....	5	PM70.....	335
FRPR418W8.....	181	LM91.....	336	PB23C.....	5	PM71.....	335
FRPR458W6.....	181	LM92.....	336	PB23MDF.....	5	PM72.....	335
FRPR458W8.....	181	MD1.....	345	PB23MP.....	5	PM73.....	335
FRPR514W.....	181	MD2.....	345	PB24.....	5	PM74.....	335
FRPR514W8.....	181	MD3.....	345	PB24-O.....	5	PM8511.....	341
FRPR714W.....	181	MD4.....	345	PB24ALD.....	5	PM8520.....	341
FRPR714W8.....	181	MD5.....	345	PB24C.....	5	PM8522.....	341
FS4916W6.....	181	MD6.....	345	PB24MDF.....	5	PM8523.....	341
FS4916W8.....	181	MLD405-12.....	89	PB24MP.....	5	PM8524.....	341
FS514W6.....	181	MLD410-12.....	89	PB3.....	5	PM8525.....	341
FS514W8.....	181	MLD425-12.....	89	PB3-O.....	5	PM8526.....	341
FS6916W6.....	181	MLD432-12.....	89	PB4.....	5	PM8527.....	341
FS6916W8.....	181	MLD460-12.....	89	PB4-O.....	5	PM8528.....	341
FS714W6.....	181	MLD490-12.....	89	PB6.....	5	PM8529.....	341
FS714W8.....	181	MLD493-12.....	89	PB6-O.....	5	PM8532.....	341
HC150-O.....	287	MLD495-16.....	89	PB7.....	5	PM8535.....	341
HC150ALD.....	287	MLD560-8.....	89	PB7-O.....	5	PM8538.....	341
HC150P.....	287	MLD564-16.....	89	PB8.....	5	PM8540.....	341
HC150VG.....	257	MLD732-12.....	89	PB8-O.....	5	PM8545.....	341
HR617-O.....	331	MLH.....	346	PB9.....	5	PM8546.....	341
HR617C.....	331	MS1.....	345	PB9-O.....	5	PM8552.....	342
HR617P.....	331	MS2.....	345	PC.....	346	PM8553.....	342
HR618-O.....	331	MS3.....	345	PF4916W6.....	351	PM8555.....	342
HR618ALD.....	331	MS4.....	345	PF4916W8.....	351	PM8557.....	342
HR618C.....	331	MS5.....	345	PF514W6.....	351	PM8558.....	342
HR618MP.....	331	MS6.....	345	PF514W8.....	351	PM8560.....	342
HR618P.....	331	OBC.....	7	PF6916W6.....	351	PM8561.....	342



Part Number Index

PM8564.....	342	PR177BFJ.....	132	PR4186.....	181	PR658DRL.....	180
PM8565.....	342	PR177FJ.....	132	PR4188.....	181	PR658L.....	181
PM8568.....	342	PR186FJ.....	133	PR418L.....	181	PR658W6.....	181
PM8569.....	342	PR192FJ.....	125	PR418W6.....	181	PR658W6D.....	181
PM8571.....	342	PR193FJ.....	125	PR418W6D.....	181	PR658W8.....	181
PM8572.....	342	PR198FJ.....	135	PR418W8.....	181	PR658W8D.....	181
PM8573.....	342	PR199FJ.....	135	PR418W8D.....	181	PR658WL.....	181
PR.....	347	PR200FJ.....	179	PR418WL.....	181	PR6916I6.....	182
PR102FJ.....	125	PR2001FJ.....	179	PR430FJ-4.....	158	PR6916I6D.....	182
PR103BFJ.....	126	PR300AFJ.....	138	PR434E6.....	181	PR6916I8.....	182
PR107FJ.....	125	PR300ALVL.....	138	PR434E8.....	181	PR6916I8D.....	182
PR108FJ.....	127	PR300BFJ.....	138	PR434EL.....	181	PR6916IL.....	182
PR110BFJ-2.....	126	PR300BLVL.....	138	PR434I6.....	182	PR713FJ.....	178
PR110FJ-3.....	130	PR304FJ.....	138	PR434I6D.....	182	PR714DR6.....	180
PR118FJ-3.....	141	PR305FJ.....	138	PR434I8.....	182	PR714DR8.....	180
PR118FJ-4.....	136, 1433	PR306FJ.....	138	PR434I8D.....	182	PR714DRL.....	180
PR119FJ.....	129	PR307FJ.....	141	PR434IL.....	182	PR714E6.....	181
PR120BFJ.....	128	PR30BB.....	7	PR434W6.....	181	PR714E8.....	181
PR123FJ.....	129	PR310FJ.....	138	PR434W8.....	181	PR714EL.....	181
PR128FJ.....	127	PR311FJ.....	141	PR434WL.....	181	PR714I6.....	182
PR129FJ.....	130	PR314FJ-2.....	138	PR4586.....	181	PR714I6D.....	182
PR131FJ.....	128	PR314FJ-4.....	143	PR4588.....	181	PR714I8.....	182
PR132FJ.....	127	PR316FJ.....	143	PR458DR6.....	180	PR714I8D.....	182
PR133BFJ.....	130	PR318BFJ-4.....	143	PR458DRL.....	180	PR714IL.....	182
PR133FJ.....	130	PR318FJ-5.....	147	PR458L.....	181	PR714W6.....	181
PR135FJ.....	131	PR321FJ-5.....	148	PR458W6.....	181	PR714W8.....	181
PR136FJ.....	136	PR323FJ.....	146	PR458W6D.....	181	PR714WL.....	181
PR137FJ.....	127	PR325FJ.....	144	PR458W8.....	181	PR715FJ.....	178
PR139BFJ.....	134	PR328FJ-5.....	148	PR458W8D.....	181	PR739R.....	273
PR139FJ.....	131	PR338FJ-3.....	140	PR458WL.....	181	PR750FJ.....	178
PR141FJ.....	126	PR338FJ-4.....	145	PR4916I6.....	182	PR751FJ.....	178
PR142FJ.....	125	PR344FJ-3.....	140	PR4916I6D.....	182	PR753FJ.....	178
PR143FJ.....	126	PR347FJ-3.....	140	PR4916I8.....	182	PR760FJ.....	178
PR146FJ-2.....	129	PR349FJ-4.....	144	PR4916I8D.....	182	PR760RFJ.....	272
PR146FJ-3.....	133	PR349FJ-5.....	148	PR4916IL.....	182	PR761FJ.....	178
PR146FJ-4.....	136	PR352FJ.....	149	PR514DR6.....	180	PR762FJ.....	178
PR148FJ.....	130	PR356FJ-3.....	140	PR514DRL.....	180	PR763FJ.....	178
PR149FJ-2.....	126	PR358FJ.....	141	PR514E6.....	181	PR764FJ.....	178
PR149FJ-3.....	133	PR362FJ-4.....	136	PR514E8.....	181	PR765FJ.....	178
PR150FJ.....	128	PR362FJ-4.....	143	PR514EL.....	181	PR766FJ.....	178
PR152FJ.....	127	PR365FJ-3.....	141	PR514I6.....	182	PR767FJ.....	178
PR152FJ-1.....	125	PR371FJ-3.....	140	PR514I6D.....	182	PR768FJ.....	178
PR156FJ.....	133	PR371FJ-4.....	144	PR514I8.....	182	PR769FJ.....	178
PR157FJ.....	128	PR372FJ-4.....	145	PR514I8D.....	182	PR770FJ.....	178
PR158FJ-2.....	127	PR372FJ-5.....	150	PR514IL.....	182	PR771FJ.....	178
PR158FJ-3.....	131	PR372FJ-7.....	153	PR514W6.....	181	PR772FJ.....	178
PR158FJ-4.....	136	PR380FJ.....	145	PR514W6D.....	181	PR773FJ.....	178
PR159FJ.....	128	PR387FJ-3.....	142	PR514W8.....	181	PR774FJ.....	178
PR162FJ.....	127	PR3916I6.....	182	PR514W8D.....	181	PR775FJ.....	178
PR163FJ.....	128	PR3916I6D.....	182	PR514WL.....	181	PR827R.....	273
PR165FJ.....	129	PR3916I6K2.....	182	PR6186.....	181	PR829R.....	273
PR166FJ.....	133	PR3916I8.....	182	PR6188.....	181	PR833BFJ.....	177
PR167FJ.....	127	PR3916I8D.....	182	PR618L.....	181	PR833FJ.....	177
PR169FJ.....	129	PR3916I8K2.....	182	PR618W6.....	181	PR833RFJ.....	272
PR170FJ.....	132	PR3916IL.....	182	PR618W8.....	181	PR841R.....	273
PR172FJ-2.....	129	PR408FJ.....	164	PR618WL.....	181	PR842R.....	272
PR172FJ-3.....	135	PR410FJ-6.....	164	PR6586.....	181	PR844RFJ.....	272
PR175FJ-2.....	129	PR4126.....	181	PR6588.....	181	PR953FJ.....	177
PR175FJ-3.....	134	PR4128.....	181	PR658DR6.....	180	PR969FJ.....	125
PR176FJ.....	132	PR412L.....	181	PR658DR8.....	180	PR970FJ.....	125



Part Number Index

PR990FJ.....	175	ROS169-O.....	5
PR990LDF.....	252	ROS169ALD.....	5
PR990MUL.....	252	ROS169C.....	5
PR992FJ.....	175	ROS169MDF.....	5
PR992LDF.....	252	ROS169MP.....	5
PR992MUL.....	252	ROS170MDF.....	5
PR993LDF.....	252	ROS171MDF.....	5
PR993MUL.....	252	ROS172MDF.....	5
PR994FJ.....	175	SS.....	347
PR994LDF.....	252	UR612B.....	352
PR994MUL.....	252	UR953.....	352
PR995MUL.....	252	WG4916W8.....	351
PR996FJ.....	175	WGAST8.....	352
PR999MUL.....	252	WGBKM6.....	352
PS.....	346	WGBKM8.....	352
R2000-O.....	321	WR.....	347
R2000ALD.....	321		
R2000P.....	321		
R2000VG.....	264		
R2003VG.....	264		
R304-O3.....	288		
R304MUL-2.....	201		
R304SP-2.....	107		
R304VG-2.....	259		
R306SP-2.....	108		
R306VG-3.....	259		
RLV18.....	88		
ROS158.....	5		
ROS158-O.....	5		
ROS160.....	5		
ROS160-O.....	5		
ROS160ALD.....	5		
ROS160C.....	5		
ROS160MDF.....	5		
ROS160MP.....	5		
ROS162.....	5		
ROS162-O.....	5		
ROS162ALD.....	5		
ROS162C.....	5		
ROS162MDF.....	5		
ROS162MP.....	5		
ROS164.....	5		
ROS164-O.....	5		
ROS164ALD.....	5		
ROS164C.....	5		
ROS164MDF.....	5		
ROS164MP.....	5		
ROS165.....	5		
ROS165-O.....	5		
ROS165ALD.....	5		
ROS165C.....	5		
ROS165MDF.....	5		
ROS165MP.....	5		
ROS166.....	5		
ROS166-O.....	5		
ROS167.....	5		
ROS167-O.....	5		
ROS168.....	5		
ROS168-O.....	5		
ROS169.....	5		



Thank you for choosing EL & EL WOOD PRODUCTS

Since 1967, we've helped architects, designers, contractors, builders and homeowners bring their dream spaces to life. EL & EL is committed to innovative thinking and processes that deliver a comprehensive product offering backed by the best people in the industry. Guaranteed.



EL & EL Wood Products
HALF A CENTURY OF SERVICE

WHOLESALE ONLY



ELandELWoodProducts.com

©2018 EL & EL Wood Products Corp. All rights reserved. EL & EL and the EL & EL Diamond Logo are trademarks of EL & EL Wood Products Corp. Registered trademarks are registered in the U.S. and may be registered internationally.